

# AUSTRALIAN CLAY TARGET

## SHOOTING NEWS

OFFICIAL JOURNAL  
OF THE AUSTRALIAN  
CLAY TARGET  
ASSOCIATION

Registered for posting  
as a Periodical  
— Category 'B'

Vol. 31, No. 11  
NOVEMBER, 1978

# The '700' Classic

NEW FROM

**Remington.**

Classic styling,  
subtle new timber  
finish and  
famous Remington  
bolt-action accuracy

We've taken our Model 700 barreled action renowned throughout the world for accuracy and reliability and fitted a deep satin-finish walnut stock with a new look and crisp, clean styling — we've created a classic — 'The '700 Classic'. Chambered in six popular calibres —

- 22-250 Rem.
- 6mm Rem.
- 243 Win.
- 270 Win.
- 30-06 and 7mm Rem. Mag.

Plus features including — full cut checkering, contoured pistol grip, rounded fore-end tip and thin brown rubber recoil pad. Remington '700 Classic' — bolt action accuracy, classic styling and superb new timber finish. Remington — shoots as well as it looks!

Ask your nearest gun dealer or write for free full-colour catalogue.

**Boustead Trading**  
P.O. Box 148, Ermington, N.S.W. 2115

**Remington.**

Best quality and value "Right out of the box"



# Why you should shoot a Browning Compound.

The Bonneville Salt Flats, September 11 & 12, 1976. The event was the World Flight Championships of the National Archery Association. When the shooting was over, Browning Compound Bows had shot both flight arrows and regular broadhead arrows further than any other competing compound bow.

The man who built this performance is Harry Drake, the master bow designer who designs Browning high performance hunting bows.

Harry has shot an arrow further than any other man in history. In 1971, using a footbow of his own design, Harry sent an arrow 2,028 yards.

(That's well over a mile and this feat is recorded in the Guinness Book of World Records.) Harry Drake knows how to design velocity into a bow. And because a faster arrow is a flatter, more accurate arrow, what he knows can really add speed and accuracy to the bow you take hunting.



**Browning Bows Are Speed Tested.** Every Browning bow design is tested on an electronic chronograph. Then we test the competition it's going to sell against.

Browning Bows consistently outshoot their competition, shooting 400 grain hunting arrows, the kind you take hunting. For example, our Compound Stalker in 60 pound draw weight can deliver a 400 grain arrow at 241 feet-per-second. If you're shooting the fastest bow you can get, your chances of bringing home the venison are better.

**Browning Bows Are Built To Last.** Browning bows are built in our archery shop, located high in the mule deer country in Utah. They're built by hand, from the finest woods, fiberglass and metal. The axles are stainless steel for long wear and no rust. Handles are carved from the finest woods for a warm grip on cold fall mornings.

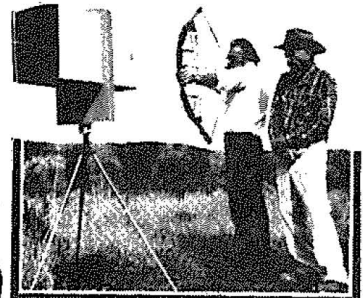
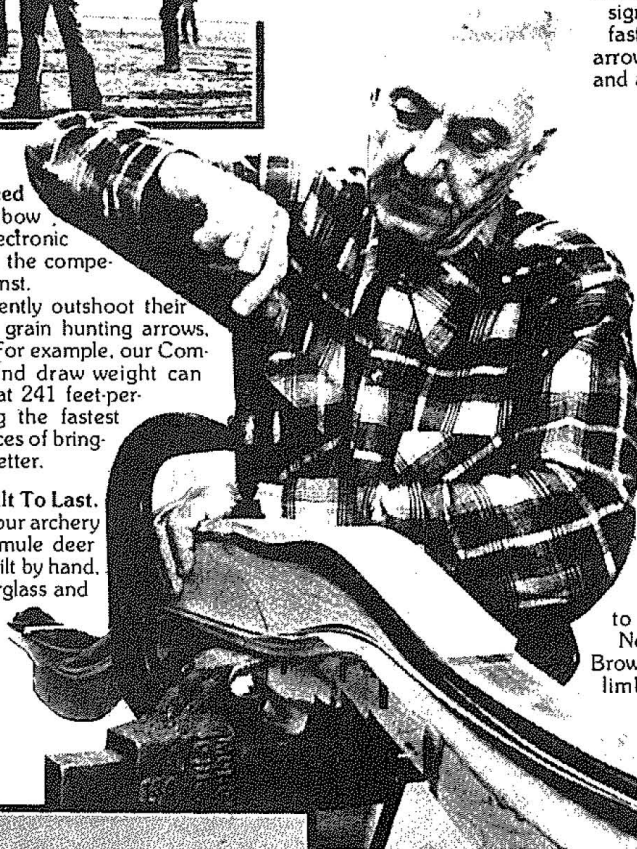

**All Browning Compounds Have Eccentric Cams Mounted in Limb Notches.** How come Browning Compounds are so fast? Well, the limbs are composite fiberglass and maple, the fastest limbs yet designed for bows. We put these composite limbs on all our compound bows, from the most expensive to the least expensive.

Next, we mount the eccentric cams on Browning Compounds in the notch in the limb, not on metal hangers. Our tests show bows with eccentric cams mounted on hangers shoot slower, because metal hangers add to the weight of the limbs.

Copyright © Browning 1977

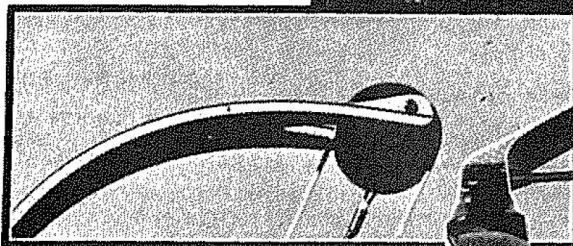

Choose from nine compound models.

Cobra	\$ 77.50
Nomad	\$ 99.95
Nomad Deluxe	\$114.95
Wasp	\$134.95
Cam-Lock	\$157.95
Bushmaster	\$194.95
Stalker I	\$157.95
Stalker II (shown)	\$159.95
Explorer	\$169.95
suggested retail price	

## **Browning**

America's Fastest Bows.

**SOLE AGENTS  
FULLER FIREARMS COMPANY, G.P.O.  
BOX 1096, SYDNEY, N.S.W., 2001**



MOBB/978

# CLAY TARGET SHOOTING NEWS

OFFICIAL JOURNAL OF THE AUSTRALIAN CLAY TARGET ASSOCIATION

**CONTENTS**

**JIM ELLIS  
WINS  
BRONZE MEDAL  
AT  
WORLD  
CHAMPIONSHIPS**



Australia's first Trap Medal in individual matches at World Championships.

**Full story in December issue of C.T.S.N.**

Why is Sports Assistance the Cinderella item in Federal Budgets? ..... 3

Report on September Executive Committee Meeting Discussions ..... 3

Talk About Travel ..... 12

Senior Federal Government Sports Administrator Addresses National Executive ..... 14

A.C.T.A. Group in U.S.A. (Part 2) ..... 16

Big International Shooting Complex Launched in Canberra ..... 19

International Shooting Scene ..... 22

Collector's Column ..... Paul Gribben 23

Trade Topics ..... 24

Secretary's Notes ..... 25

Eley School Championship — Bendigo Clay Target Club ..... 25

1978 National Trench Championships ..... Pat Browne 26

1st National Olympic Skeet Championship ..... John Turner 29

Victorian State Carnival ..... Laurie Connors 30

State Association's Report ..... 32

President's Report on U.S.A. Trip ..... Ern Hawkins 33

'Nationals' Planning Proceeds Smoothly ..... 34

Editor's Mailbox ..... 35

Victorian State Carnival ..... 'Ghostie' 36

Shoot Results and Programs —

    New South Wales ..... 37

    September Open Shoot — Cowra Gun Club ..... 53

    Finley Gun Club Helps Celebrate Town's Centenary ..... 53

    Downside Wins Boomerang Shield ..... 53

    N.S.W. Trap Carnival — West Wyalong ..... 54

    Queensland ..... 55

    Arthur Kenna Reports for C.T.S.N. .... 60

    South Australia ..... 62

    1978 ISU Skeet Championship Photos ..... 64

    Australian Capital Territory ..... 65

    Tasmania ..... 65

    Charity Starts at Burnie ..... 66

    Western Australia ..... 67

    Northern Territory ..... 68

    Victoria ..... 69

    Eley Team's Final ..... 88

    1978/79 Season Opens at Kerang ..... 89

    More Pics from V.C.T.A. Trap Carnival ..... 89

An Unconventional Ferret ..... 90

How to Cover Trap & Skeet Shoots

    Remington Newsletter 90

Clay Target Sports Offer Unique Lifetime Values

    Remington Newsletter 90

Shooters' Crossword ..... 91

Gun Talk ..... Pat Browne 92

*FRONT COVER: The World's largest DTL facility. The photo shows the home of the 'Grand American' in full swing. 72 trap fields from one end to the other!*

**All correspondence should be addressed to:  
Noel J. Southey, National Secretary  
G.P.O. Box 20385 Melbourne, Vic. 3001.  
Phone (03) 63 9777 or 63 7596**

CTSN is the official journal of the Australian Clay Target Association and is published monthly at Waterwheel Press Pty. Ltd., 159-165 High Street, Shepparton, Vic. 3630.

Subscription rate is \$10 per annum.

**COPY CLOSES FOR DECEMBER ISSUE — 1st NOVEMBER**  
Copy closes for January issue — 27th November

*Contributions: Club or shooter contributions are welcome, either manuscript or photographs, or both. Preferred photos are black and white glossy prints.*

# Why is Sports Assistance the Cinderella Item in Federal Budgets?

\$1,333,000 allocated to sports assistance in 78,79 Federal Budget, an increase of 33 1/3% over 1977/78?

SO WHAT !!!

In the 1977-78 Budget allocation to sport was \$1 million dollars ever, EFFECTIVELY this support was for a period of around seven months ONLY! On this basis alone, it will be clearly seen that the 78/79 allocation is a REDUCTION of over 30%. Furthermore the Government already had a forward commitment for 78/79 of \$500,000 to provide continuity of the full-time position arising from last year's funding.

IN PRACTICAL TERMS, for new initiatives, sport has been allocated only \$850,000 for 1978/79. Consequently, a number of sports including clay target shooting will receive funding assistance which for the current period will have very limited effect BECAUSE IT IS SPREAD TOO THINLY!

Who is at fault? Basically, Australia's sportsmen and women are at fault, because of their complacency. We all sit back and wait for things to happen. When it doesn't happen, we bleat like sheep! Would it not be better to get off our butt and do something to influence the decision before it is made, rather than cry into our beer after an unfavourable result.

However, there are other problems. There can be no doubt that sports participation MUST have some connection with a nation's health standards. Yet what could be called health cure programs are allocated hundreds of millions of dollars annually. Why not more for prevention programs (i.e. sports development) — we have oft times been told that prevention is better than cure. Then of course we are tempted to look at the Arts. The following figures have been taken from the 1978/79 Federal Budget:

Australian Opera .....	\$2,520,000
Australian Ballet Foundation.....	1,344,000
Australian Elizabethan Theatre Trust Orchestras .....	2,131,000
Public Lending Right Scheme .....	885,000
General Support for Arts .....	15,470,000
Administration.....	3,601,000

Firstly, let it be quite clear that there is no dispute with a policy of supporting the Arts in Australia. Any readers who have travelled internationally will readily accept the deep need for such support. But \$26 m. for the Arts against \$1.3 m. for Sport seems to be too large a gap. Perhaps sports aren't socially acceptable. Perhaps the fact that senior Cabinet Ministers regularly appear in the guest lists of openings of Ballet and Opera seasons, or important art shows, means that as a group, sports have not done sufficient work to establish themselves socially. (A good example of this recently received press publicity, when Prime Minister Fraser could only get into the Rugby Grand Final in Sydney because a benevolent LADY gave up her seat!)

So there is the challenge — does Australian sport continue to depend for assistance on the efforts of too few administrators, or can a way be found to get Australia's 4,000,000 participant sportsmen and women off their backsides, and express their COLLECTIVE concern?

It is interesting to note that soon after the 1976 Olympic Games, Prime Minister Fraser, still smarting from criticisms he received whilst at Montreal, accepted an appointment as patron of the Confederation of Australian Sport. Although readers may find the connection difficult to see, 1980 is both an Olympic and an election year. Maybe, just maybe, the present Government can be influenced before the 1980 election.

(Because of the importance of long term development of sport in Australia, and because that development is considered in part to be a Federal Government responsibility, the November "Secretary's Notes" have vacated their prime space. The column will be found on page 25). ○

## Report on September Executive Committee Meeting Discussions

The Second National Executive Committee Meeting for 1978 was conducted at the Koala Oxford Square Hotel, Sydney, from the evening of Friday 22nd September until late Monday 25th September. It is evidence of the enthusiasm being shown by members of the Executive Committee that there was a full attendance which included two new faces. Mr Neil Hardy a dental surgeon of Townsville, Queensland, has been appointed to the Executive Committee to replace Mr Arthur Kenna whose resignation was reported in the last issue of C.T.S.N., and Mr Len Bird of Cowra, N.S.W., has been appointed to fill the vacancy caused by the resignation of Mr Bruce Noll of Condobolin. The Agenda had been arranged so as the appointment of these two new members could be confirmed as early as possible to enable them to participate in the complete meeting. Tangible evidence supporting the present policies relating to selection of members for the Executive Committee can be drawn from the fact that both these new appointees made a significant contribution to the quality and standard of the meeting. In fact it should be placed on record that the meeting is by far the most effective which has been held in recent years.

On a sadder note all Executive Committee members were shocked at the illness which afflicted the National President early in the Monday session of the meeting, and which resulted in him having to leave the meeting and, after a long rest, quietly drive home. President Ern had been unwell for some time prior to the meeting and it was only his dedication to the responsible job he has undertaken that enabled him to take his place in the chair at the commencement of the meeting. The weekend was particularly trying one and eventually took its toll. It was a most unfortunate occurrence and I am sure I speak on behalf of all of the National Executive and our National membership when we extend to President Ern best wishes for a quick recovery.

Now to the matters debated during the meeting. It was an extensive Agenda with 30 major topics listed for discussion. It is the intention of this report to cover those items which are of interest to the general membership of the Association. For simplicity the order of this report has been kept to the order of debate — it may seem that there is a lack of continuity and we apologise for any inconvenience such a lack may cause.

1. Administrative Report. Arising from the Secretary/Manager's Administrative Report were several recommendations. These included:

Cont'd over page.

# WINCHESTER

BROWNING — BÉRETTA

● Special Discount available to shooters!!!

**EVANS & BALFOUR** PTY. LTD.

Official Winchester Warranty Gunsmiths.

269 LITTLE COLLINS STREET  
MELBOURNE 3000  
Phone (03) 63 7841

**NEW RELEASE**  
and it's a winner  
Winchester Pigeon  
Grade Model  
10184 (76 cm barrel).  
Has the latest deluxe 10 mm trap rib.

Discount Price Available.

**Report on September Executive Committee Meeting Discussions (Cont'd)**



• Western Australian Executive Committee Member, Mr R. Holtfreter.



• One of the newer members of the committee, Mr W. Abbott, Werribee, Victoria.

(a) A Franking machine is to be introduced into the National office to ease the postage burdens currently being faced by the administrative staff.

(b) To ensure prompt payment of any Travel Grant to which a member becomes entitled, a separate banking account is to be opened for this purpose.

(c) Arrangements are to be made to enable the National office to become a processing unit for the placement and supply of spare parts for Winchester Traps.

(d) The Executive Committee supports further investigation into the possibility of creating an Australian Hunting and Shooting Sports Foundation.

2. **I.S.U. Sub-Committee.** In presenting this report the Chairman of the I.S.U. Sub-Committee Mr Harry Somers of Sydney made the following points:

(a) Australia's International involvement in 1978 has been at the highest level ever achieved.

(b) That the development of I.S.U. Committees at a State level has not proceeded satisfactorily.

(c) The 1979 National Championships in Olympic disciplines will be conducted at the Downside International Gun Club, Wagga. The date is yet to be decided. However the program will be arranged to enable shooters who wish to compete in both disciplines to do so.

(d) Approval be granted to Melbourne Gun Club to conduct the 2nd Pacific Open International Shooting Championships during Easter 1979.

(e) A recommendation that the National Executive endorse a decision by the I.S.U. Sub-Committee to encourage Clubs staging National Olympic Discipline Championships to hold these events on the week-end which coincides with the Melbourne Cup, usually the first weekend in November.

(f) The two vacancies on the Sub-committee (caused by the resignations of Messrs Kenna and Noll) have been filled by Neil Hardy from Queensland and Keith Sim from New South Wales.

3. **Clay Target Shooting News Committee Report.** Firstly Mr Hawkins as Chairman of that Committee reported that, resulting from the recent calling of tenders, arrangements have now been made to appoint Waterwheel Press as the magazine printer for a further three years. Reference was also made to the tremendous example set by Executive Committeeman Laurie Connors in contributing a monthly column to the magazine.

Under this Agenda item a letter received from a leading Gun Club was tabled — in this letter the Club had asked that the National policy on editorial content of Clay Target Shooting News restrict subjects to matters relating directly to shotguns and to clay target shooting. The Executive Committee made it quite clear that our prime objective was to promote shooting both in Australia and overseas on the understanding that, as a direct result of shooting gaining a better image, so there would be more clay target shooters come into our ranks.

4. **State Association Reports.** Although most matters covered in these reports will have been mentioned elsewhere in Clay Target Shooting News issues it is important to realise the significance of the acceptance by Queensland Premier Mr Joh Bjelke Petersen of a position as Patron of the Queensland Clay Target Association. As our needs in political areas increase, it consequently becomes of increasing importance that we mix in the right circles. The Queensland Clay Target Association is to be complimented on its foresight in this matter.

On behalf of the New South Wales Association Mr H. Somers spoke on a need of the newly formed Murrumbidgee Irrigation Area Trench Association for some financial assistance to enable that body to get its Olympic Trench operational. Unfortunately the Association currently has no firm policy on this subject and the matter has therefore been deferred until the March meeting.

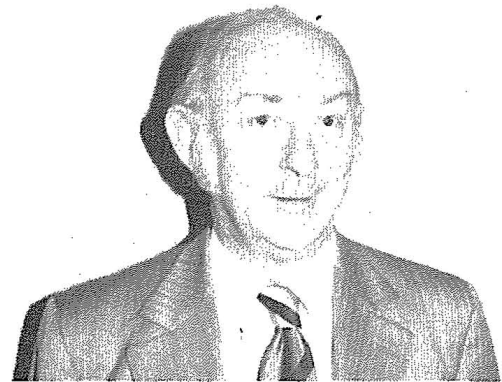

• Chairman of the ISU Sub-Committee, Mr H. Somers, Sydney.

5. **National Shooting Ground.** The subject of the National Shooting ground continues to cause more concern to the National Executive Committee than possibly any other confronting it. This is a natural development as the decision on whether or not to develop a National ground will be one of the most far reaching ever made. *Nevertheless, time is getting by and it is vitally important that the Association reach some decisions in this regard as soon as possible.* The only decisions reached at this meeting were: (a) That the Association have a policy based on initially using one National ground; and (b) That the Core Group of the Association investigate the alternatives available and report back to the next meeting of the Executive Committee.

6. **International Commitments.** Brief reports were tended to the meeting on the subject of the Commonwealth Games Training Camp as well as the teams' performance whilst overseas. There was also a verbal report delivered on the preparation for the World Championships Team which at the time of the meeting was overseas.

**Cont'd on page 6.**

—————: **FOR SALE** :————

<p><b>TEXAN 600 AUTO LOADER \$325 ono</b> All Accessories — Good Condition</p> <p><b>WINCHESTER 1400 SKEET GUN \$200</b></p> <p><b>D. F. Colwell</b> (067) 43 1719</p>	<p><b>PONSNESS &amp; WARREN RELOADER \$375</b> Press Model 800B size-o-matic. Good Order.</p> <p><b>SMALL CLAY TARGET SET UP</b> Including 4 moulds, heating equipment and quantity of material.</p> <p><b>S. G. Wilson</b> (067) 69 8284</p>
--	---

# BRNO SHOTGUNS

## THE UNIQUE ZH 300 O & U SERIES

A shotgun that combines the convenience of five different barrel combinations with a trigger set up that is truly unique. The ZH has twin triggers — the rear trigger when used for Trap or Skeet Shooting, discharges the bottom barrel then the top, whilst the front trigger is designed for Field Shooting or with the rifle's combo's and discharges the top barrel only. So you have the advantage of a single trigger selection that can be matched to the 30" Hunting, 28" Trap, Skeet or to the two Shotgun Rifle Combination Barrels. Truly a shotgun to suit any of your shooting requirements.

MODEL NO	BARRELS	DESCRIPTION	ILLUSTRATION	SUGG RETAIL PRICE
<b>ZH-301</b> — Standard Over and Under Shotgun for Hunting		Gauge 12 Barrel length 700 mm Chamber 29/4 ins Overall length 1130 mm Weight 3.20 kg Pattern percentage at range with No. 3 (0 3.5 mm) shot 35 m 60-70%		<b>\$ 375.00</b> (Gun Complete) \$ 224.00 (Barrel Only)
<b>ZH-302</b> — Over and Under Shotgun for Skeet Shooting and for Short Range Hunting in Woods		Gauge 12 Barrel length 660 mm Chamber length 70 mm Overall length 1090 mm Weight 3.30 kg Pattern diameter at 20 m range 750 mm 30 ins		<b>\$ 224.00</b> (Barrel only) \$ 375.00 (Gun Complete)
<b>ZH-303</b> — Special Over and Under Shotgun for Trap Shooting and for Hunting Over Long Ranges		Gauge 12 Barrel length 760 mm Chamber length 70 mm Overall length 1190 mm Weight 3.50 kg Pattern percentage at range with No. 7 (0 2.5 mm) shot 35 m 70%		<b>\$ 224.00</b> (Barrel only) \$ 399.00 (Gun Complete)
<b>ZH-304</b> — Universal Hunting Over and Under Rifle/Shotgun		Rifle barrel upper Calibre 7X57 R Gauge 12 Barrel length 600 mm Shotshell chamber length 70 mm Overall length 1030 mm Weight 3.45 kg Rifle barrel sighted in for 100 m 23.6 ins 23/4 ins 40.5 ins 7.6 lbs 110 yds		<b>\$ 224.00</b> (Barrel only) \$ 375.00 (Gun Complete)
<b>ZH-305</b> — Universal Hunting Over and Under Rifle/Shotgun		Rifle barrel upper Calibre 5.6X52 R Gauge 12 Barrel length 600 mm Shotshell chamber length 70 mm Overall length 1030 mm Weight 3.60 kg Rifle barrel sighted in for 100 m 22 Savage 23.6 ins 23/4 ins 40.5 ins 7.96 lbs 110 yds		<b>\$ 224.00</b> (Barrel only) \$ 399.00 (Gun Complete)

DEALER ENQUIRIES:

**COMMERCIAL MARKETING CO. PTY. LTD.**  
PO BOX 423, ARTARMON, NSW 2064. AUSTRALIA  
Support your sport, join a shooting association.

12 gauge, 5.6 x 52R (.22 Hi Power Savage) and 7 x 57R ammo also available ex. stock.  
Brno, a firearm that has retained unrivalled support from the hunter for generations.  
Available from firearm specialists who know quality.

## Report on September Executive Committee Meeting Discussions (Cont'd)

Then Mr Ron Porter as Delegation Leader for the Australian Group which visited New Zealand earlier this year presented a detailed verbal report on his group's success. He made special reference to some of the early difficulties on policy matters which developed between the New Zealand Clay Target Association and Overseas Entries in their National Championships and commended the New Zealand Clay Target Association for the mature way in which they approached the problem. Mr Porter also reported the discussions which took place between the two Associations on the matter of rules parity and this matter is to be further developed at the next available opportunity. The Committee received Mr Porter's report with acclamation and made an official note congratulating Mr Porter on his dedicated efforts in managing the Australian contingent.

*(It was decided as a result of the problems which confronted the New Zealand Association in relation to trophies to which conditions had been attached, that at Australian National Championships any conditions be advertised as such in the Official Program and the Association is to have a suitable trophy available to present to a winner who is ineligible for the original trophy because of those conditions).*

Mr Abbott (Victoria) then delivered a verbal report on the recent successful tour to Singapore. He made special reference to the professionalism of the travel arrangements made by Jetset Tours in their capacity as the official travel consultants to the Australian Clay Target Association. He reported that every member of the group (which numbered 20 people) thoroughly enjoyed themselves and many have already committed themselves to return to Singapore in 1979. He also made reference to the enthusiasm shown by a number of the International entrants in the Pesta Sukan Games towards the idea of visiting Australia in 1979 for a truly International Match. The shooting results of his group were recorded in the October issue of Clay Target Shooting News. Mr Abbott's report was also received with acclamation and he too was complimented on leading such a responsible Australian group. Others involved in the Singapore success to whom special reference should be made include George Breman who did a lot of refereeing during the International Shooting Matches attached to the Pesta Sukan Games and Merv Whitelaw who did most of the original planning work connected with the tour.

Then followed a written report from the National President Mr Hawkins who led the 32 person Australian group to U.S.A. for the Grand American Tournament. This report is published elsewhere in this issue of the magazine.

The final item under this heading refers to Australia's delegation to New Caledonia which was due to leave Australia on 29th September. Squadron Leader Stan Harding, President of the R.A.A.F. Club at Pt. Cook, Victoria, was appointed Delegation Leader.

7. **Simulated Field Shooting and Affiliation** with the International Organisation called F.I.T.A.S.C. As simulated field shooting activities grow throughout the clay target shooting world both at a National and International level it is becoming increasingly obvious that Australia as a nation will need to do something officially in gaining recognition. Whether or not this matter should be handled by the Australian Clay Target Association or by the Field & Game Federation of Australia was discussed and resolution was reached that the A.C.T.A. would approach F.I.T.A.S.C. seeking copies of its aims and objectives and its constitution.

Meanwhile an application had been received from Northam Gun Club in Western Australia to conduct a National Simulated Field Shooting Championships in 1979. It was resolved that the

Australian Clay Target Association would write to the Field and Game Federation of Australia supporting Northam Gun Club's application for the 1979 National Simulated Field Shooting Championships. However it must be stressed that this is simply intended to be a supporting letter and in no way designed as an attempt to tell the Federation what they should be doing with their National Championships.

8. **Constitutional Change.** The problems connected with the proposed Constitutional changes continue to dog the Australian Clay Target Association to such an extent that some wonder whether the necessary changes will ever become effective. Once again the Executive Committee spent much of its time debating the advantages and disadvantages of the present proposals and finally re-

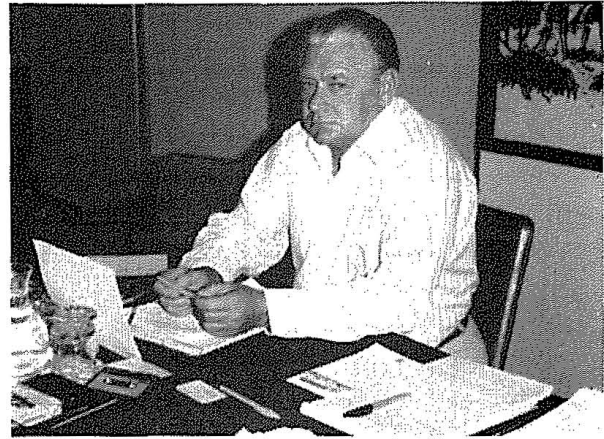

● Acting Chairman, Ron Porter. Ron took the chair after the unfortunate illness of President Ern.

solved to put the present proposals to the 1979 Annual General Meeting at Griffith N.S.W. Mr Roy Holtfreter of Western Aust. had prepared a very worthwhile submission on this subject and it was considered sufficiently explanatory to be suitable for circulation to all Clubs throughout Australia. Such a circulation has now been undertaken and should any reader have further questions on this matter would he please discuss them with his Club Committee.

9. **Insurance.** The Secretary Manager had prepared two data sheets on this subject, one relating to the possible need to increase the total cover of the Association's Legal Liability Policy, and the second provided information on the possibility of giving Clubs insurance cover for voluntary workers. On the first subject, the Legal Liability Policy, is being increased from \$200,000 maximum to \$500,000 maximum for 1979. On the second suggestion, because premium costs averaged in excess of \$100 per Club, the matter was shelved — the only decision being to circulate the information to any interested Clubs.

10. **Change of Age for Junior Qualifications.** It has been resolved that from 1st January 1979 the Association will recognise junior shooters as only those shooters under the age of 17 years at the time of registering. This is significantly different from the present rule which recognises shooters 18 years and under. **WOULD ALL CLUB SECRETARIES PLEASE NOTE THIS CHANGE.**

Cont'd on page 8.

—★ FOR SALE ★—  
**BROWNING SKEET GUN**

**B2E-GRADE . . . LIST \$3080.00**

New in box with pattern sheets

**\$1750.00**

**\$1750.00**

**PHONE (03) 386 6757**

—★ FOR SALE ★—

**BERETTA S03/EELL  
U/O TRAP GUN**

In as-new condition, ¾ and full choke, with case and original papers — \$3250 (firm).

**NOTE NEW PHONE NUMBER:  
Telephone: Melbourne 317 9781**



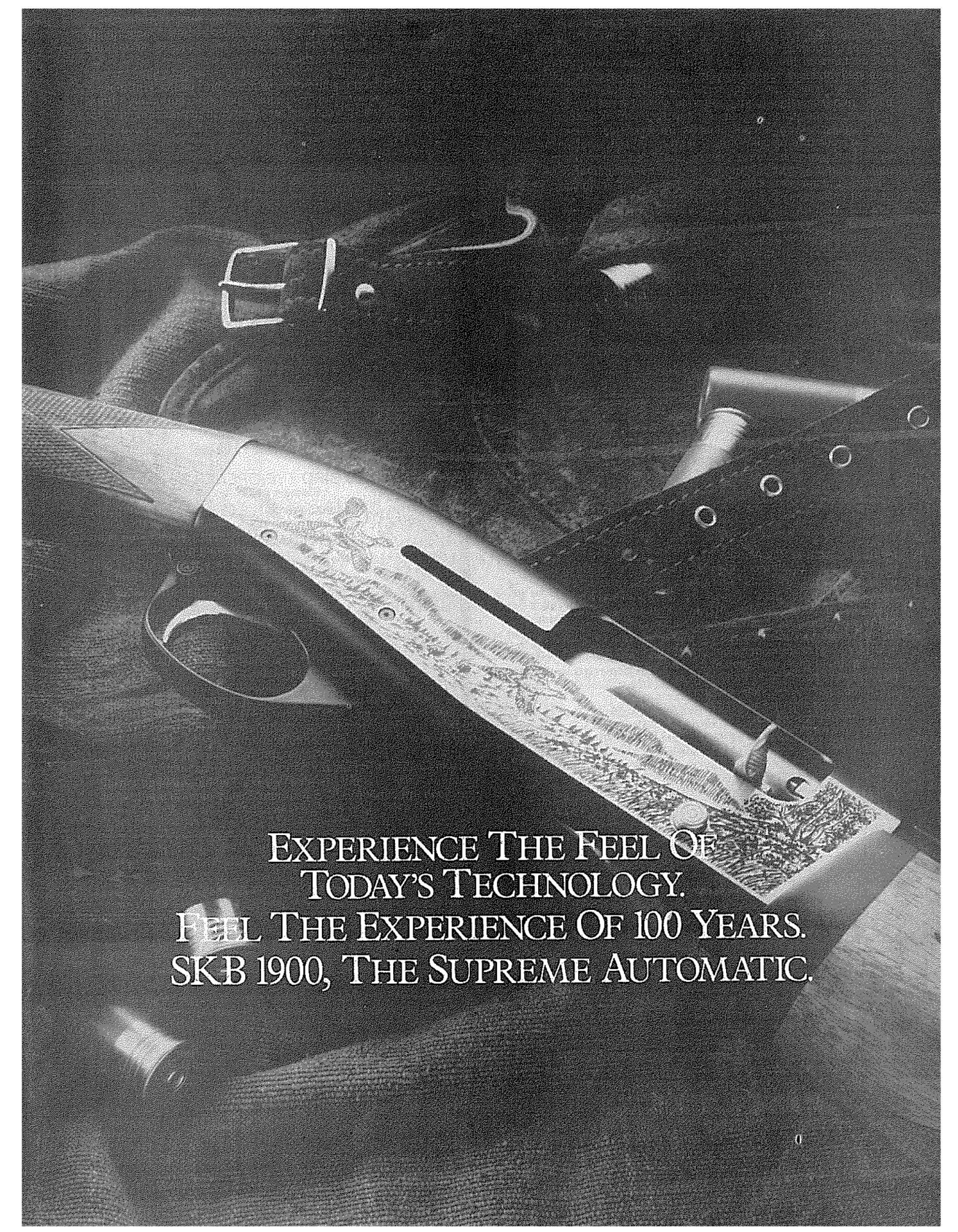

EXPERIENCE THE FEEL OF  
TODAY'S TECHNOLOGY.  
FEEL THE EXPERIENCE OF 100 YEARS.  
SKB 1900, THE SUPREME AUTOMATIC.

## Report on Executive Meeting (Cont'd)

11. **Structure of Team Entries in Allan Brown Club Teams Match at Nationals.** It was resolved that at future National Championships in any Club Teams' Match the entrant Club team may only include members whose registration has been taken out through that Club.

12. **Classification of Referee Examiners.** In a major change of policy in relation to the status of Referee Examiners it has been resolved that Referee Examiners will in future be appointed under the following headings:

- (a) Referee Examiner Trap and Skeet
- (b) Referee Examiner Trap
- (c) Referee Examiner Skeet.

This change will make it very much easier for areas in which skeet is not as well developed as the Association would like to see it, to have a Referee Examiner appointed for trap only.

13. **Concessions to Veteran Shooters.** Resolution was reached that a special badge be struck to recognise the length of service of registered shooters whose continuous membership has exceeded 25 years. Furthermore a special bar will be produced for attachment to the badge in recognition of shooters who have exceeded each successive five years of membership. As further recognition of the contribution long serving members have made to the development of the Clay Target Association a membership concession will be offered to all those who have achieved the age of 60 and who have continuous registered membership of 30 years. *The concession will be half of the current adult fee.* Unfortunately because this decision can only be a recommendation to an Annual General Meeting it will be 1980 before the full effect of this concession can be felt.

14. **The Executive Committee** devoted much of its discussions to the topic of providing hospitality and courtesies to visitors to various shooting matches. This matter is of vital concern as it will have a significant bearing on the long term development of clay target shooting. This is particularly the case at National Championships and the Executive Committee has pledged itself to ensuring that International visitors and any guests are made to feel very welcome during forthcoming National Championships. However, Clubs also have a very real responsibility in this matter and an appeal is made to all Club committees to ensure that any visitors, whether they be registered shooters or not, always have some recognition offered to them.

15. **Travel.** As a result of the travel report presented by the Secretary/Manager, the Executive Committee resolved that Ansett Airlines of Australia, Air New Zealand and Jetset Tours each be commended for their efforts in giving the Australian Clay Target Association such tangible support.

16. **National Status of Ball Trap Events.** As a result of an enquiry from a Victorian Club which had just installed a Ball Trap it was resolved that every effort be made to encourage Ball Trap shooting throughout Australia. It is acknowledged that the development of Ball Trap matches will play a very significant part in the growth of Olympic Trench shooting and thus will give Australian shooters a much better opportunity to develop their standards. Commonwealth and State Ball Trap Championships are to be added to the allocation list and will be available for the first time in 1979. The 1979 Commonwealth Ball Trap Championship has been allocated to Victoria and the Victorian Clay Target Association will choose the host Club.

17. **Deletion of the National Skeet Championship** from the National Clay Target Championships program. An attempt to have the National Skeet Championship used as the basis for a National Skeet Carnival was defeated because the Executive Committee considered that the move had come a little too soon. There appeared to be general consensus that ultimately the National Skeet Championship will be able to be conducted in its own right but at the present time skeet shooting in Australia does not have sufficient widespread support to justify making a separate carnival out of the National Skeet Championship.

18. **International Air Tickets to be used as trophies.** Readers will be well aware of the involvement of Air New Zealand in assisting the Australian Clay Target Association with International travel. As a result of this assistance the A.C.T.A. receives an opportunity to send two standard trap teams overseas each year - one to New Zealand and one to the U.S.A. In the past it has been the Association's policy to leave the members of each of those two teams to fund their own costs in reaching an East Coast port of departure. From 1979 the Association has now agreed to pay the assembly fare costs of team members and this will be a welcome change of policy to those seeking positions in these teams.

Cont'd on page 10.

# Field and Game Federation of Australia

## Second National Field and Game Simulated Field Shooting Cham- pionships

to be held at

### Geelong Branch Shooting Ground

situated at Murgheboluc (see Map)

OPEN TO FIELD & GAME

MEMBERS ONLY

SATURDAY & SUNDAY,  
4th & 5th NOVEMBER, 1978

**SATURDAY 4/11/78**

8.00 am start

Nominations close 10.00 am

Event 1 Nom \$3.00

20 BIRD EYE OPENER

Sweeps \$1.00.

Nominations close 1.00 pm

Event 2 Nom \$8.00

40 BIRD NATIONAL

FIELD & GAME C'SHIP

20 Birds only SB U/15 \$2.00

Nominations close 3.00 p.m.

Event 3 Nom \$4.00

20 BIRD "ED MORGAN"

MEMORIAL GRADED C'SHIP

A B C D Grades. Under 15 & 18 Graded A & B Trophies.

Gradings established from event 2.

**SUNDAY 5/11/78**

Nominations close 1.30 p.m.

Event 4 Nom both \$32/Team

12 noon start

40 BIRD FIELD & GAME

FEDERATION TEAM SHOOT

4 Man Teams. Shot in conjunction with Graded Handicap from events 2 & 3 (Under 15 20 targets, S.B. Nom \$2.00).

Handicap only \$6.00.

**Total Trophy Value \$1,500.00 Minimum  
Guaranteed. Junior Nominations Half  
Price.**

Accommodation Enquiries: Allan Graham, 7 Teleta Crescent, Corio, 3214. Tel (052) 75 3199.

General Enquiries: The Secretary, Box 255, P.O. Geelong, 3220. A. J. Graham, Hon. Secretary Field & Game Federation of Australia.

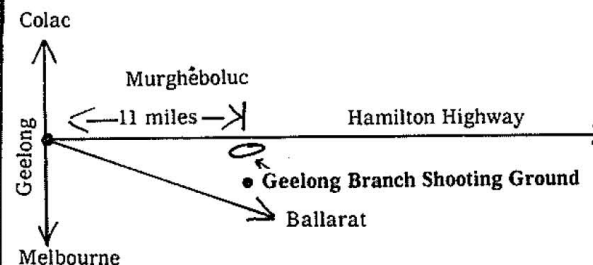



Space Age Technology  
and research developed  
by the mighty

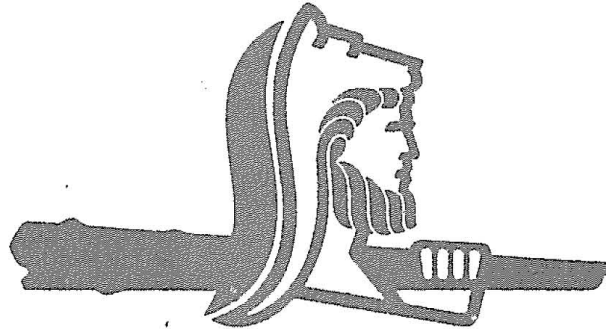

**HERCULES**  
INCORPORATED  
ANNUAL SALES \$1.6 BILLION

brings you better re-loading  
powder than ever before



**HERCULES  
POWDER**  
gives more shots  
for your dollar

Recommended Retail Price Per lb.

- |   |         |
|---|---------|
| ● <b>RED DOT</b>  | \$ 8.65 |
| The preferred powder for light-to-medium shotshell use: specifically designed for 12-gauge target loads.        |         |
| ● <b>GREEN DOT</b>  | \$ 8.65 |
| Designed for use in 12-gauge medium shotshell loads.  |         |
| ● <b>RELODER 7</b>  | \$10.06 |
| Benchrest grade for outstanding accuracy in centre-fire rifle cartridges. Use as specified in Hercules booklet. |         |
| ● <b>BULLSEYE</b>   | \$10.06 |
| A high-energy, quick burning powder designed for pistol and revolver use.                                       |         |
| ● <b>UNIQUE</b>   | \$ 8.65 |
| An all-round powder   |         |
| 2400 RIFLE POWDER   | \$10.06 |

**HERCULES**  
with \$1.6 Billion Sales  
excels in propellants  
from small pistol ammunition  
to space rockets

Hercules Inc. is one of America's largest companies. In 1977 Hercules spent thirty-seven million dollars on research and development. A FURTHER FORTY-TWO MILLION DOLLARS WILL BE SPENT IN 1978.

Emphasis on research continues to strengthen the competitive position of Hercules Powders through product improvement and process economies.

Propelling a rocket to the moon, or propelling lead to the target - its all the same to Hercules.

**Insist on Hercules Powder**  
• Soft on your shoulder  
• Soft on your pocket  
• Tough on targets

ASK AT YOUR GUNSTORE  
**FULLER FIREARMS COMPANY,**  
**G.P.O. BOX 1096, SYDNEY, 2001**

MOHC/978

## Report on September

### Executive Committee Meeting Discussions (Cont'd)

19. **Appointment of Queensland Rules Supervisor.** The Executive Committee resolved to appoint Mr Arthur Kenna as the second Rules Supervisor for the State of Queensland.

Agreement was also reached that in an attempt to assist Papua New Guinea in improving her standards in trapshooting areas that a Rules Supervisor would be sent to that country to conduct a Referee Discussion Panel and also to appoint a Referee Examiner. Mr Arch Rowe of Yamba, N.S.W., was asked to accept the responsibility and an effort is being made to arrange his visit for November 1978.

20. **Dress at Affiliated Gun Clubs.** A very spirited discussion took place on this topic and a unanimous decision was reached that *thongs be disallowed on shooting tracks at any affiliated Club in Australia. This applies as much to practice shooting as it does to competition and should be strictly enforced.* Furthermore suitable attire should be worn at all times by members and their guests as in this way to image of the sport will be substantially elevated.

21. **National Logo Competition.** The Executive Committee expressed its appreciation for the interest which had been shown in this competition. Over 80 entries were received many of which showed a great level of imagination. The winning entry is that tendered by Mr Jim Shepherd of Maryborough, Victoria, and is as follows:



The Association has expressed its congratulations to Jim and further work is now taking place in relation to selection of colors and production arrangements. Because of the long-term significance of this decision a final decision on color will not be made until the March meeting of the National Executive Committee.

22. **Reimbursement of Promotional Funds.** V.C.T.A.-Agreement was reached that an expense of \$350 which the Victorian Clay Target Association had incurred in the preparation of promotional notes being attached to renewal notices for Victorian Shooters licences should be refunded to the Victorian Association.

23. **Determination of Standards of Clay Targets.** The Executive Committee expressed concern at the growing number of criticisms being received from Clubs and shooters about the variations in performance of clay targets. As a result of this the National office is to undertake an investigation with the objective of introducing written standards for clay targets for use by affiliated Clubs. This matter is to be further discussed at the March 1979 Meeting of the Executive Committee.

As mentioned earlier in this report the low note of the meeting occurred when President Ern found it necessary to vacate the chair due to ill health. This placed an enormous load on Vice President Ron Porter who became Acting Chairman. The Association's Executive Committee meetings these days are conducted under such pressure that it is no easy task to chair one. To be thrust into the position at such short notice makes the task even more difficult. Nevertheless, as one would expect from an old campaigner, Ron Porter rose to the occasion and performed more than adequately. *In fact this matter alone must have given President Ern certain peace of mind.*

All in all it was a most successful conference and many of the decisions reached will make a significant contribution to the future development of clay target shooting in Australia. (At the time of going to press the condition of our National President Ern Hawkins has improved considerably and providing he does not overdo it, he should be 100% fit again in a few weeks). ○



# CLAY TARGET



NATIONALS '79

# WANTED WANTED

APPLICATIONS are being called for the position of:—

- a) **Shoot Marshal** (\$50 per day)
- b) **Assistant Shoot Marshal** (\$40 per day)
- c) **Referee — Trap and/or Skeet** (\$60 per field per day — three refs per field)

for the 1979 NATIONAL CHAMPIONSHIPS to be held at Griffith Gun Club from 7th March to 13th March 1979.

Applications close on 30th November and should be addressed to:—

Chairman,  
'79 NATIONALS  
ORGANISING COMMITTEE

C/o A.C.T.A.  
G.P.O. Box 2038S  
Melbourne. 3001.

# WANTED WANTED WANTED

For target-breaking power choose

**FEDERAL<sup>®</sup> U.S.A.**

the finest components ever loaded into a trap shell for smooth, consistent performance.

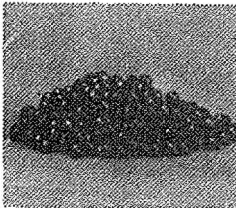

**EXTRA-HARD SHOT** provides denser, more even patterns, higher retained velocity, and maximum target-breaking impact. More costly, but worth it. Federal pioneered extra-hard shot when we increased the amount of antimony, a hardening agent, used in each lead pellet. Knowledgeable shooters say that one extra-hard pellet will break a clay that others only dust.

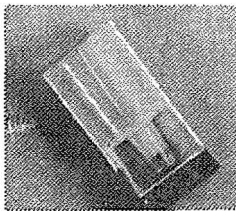

**CHAMPION WAD** – Truly unique among wads, the Champion wad has a totally enclosed air-cushion centre section with an internal support post for controlled collapse. On firing, the centre section squeezes out to provide additional sealing. The two-piece construction means an extra assembly operation for us, but a decade of shooter success proves its worth.

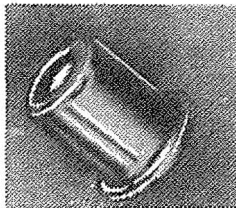

**FEDERAL 209 PRIMER** – Known for its greater ignition potential, the No. 209 primer uses our own special mix, made with "Basic" Lead Styphnate. The anvil, cap and battery cup are manufactured to strict tolerances; assembly operations are carefully inspected to reduce the chance of a misfire. Non-corrosive and non-mercuric, of course.

**FEDERAL<sup>®</sup>**

**PRECISION CARTRIDGES**  
as used by the 1978 Clay  
Target Champion of America  
are loaded with famous  
**HERCULES POWDER**

KEEP PRICES DOWN  
Dealer and Club Enquiries

**FULLER FIREARMS COMPANY,**  
**G.P.O. BOX 1096, SYDNEY, 2001**

**CHAMPION II MONOHUL –**  
**RE-LOADABLE UP TO 16 TIMES**

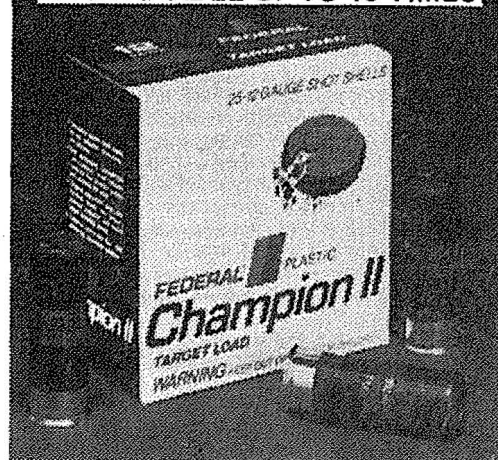

MOFC/978

# TALK about TRAVEL

This month's column is headed by a comparison between the Australian Clay Target Association and the Australian Council of Trade Unions. What has that to do with travel you may ask. Well read on. There are a number of curious coincidences between the two organisations, which culminated in the recent announcement that the ACTU has formed a Leisure Club through which its members can obtain travel benefits.

Let's look at the similarities, one by one. Firstly, the abbreviations — ACTA and ACTU. Then the National President of the ACTA is Ern HAWKINS while the National President of the ACTU is Bob HAWKE. Have you noticed that President Ern and Bob Hawke LOOK very much alike. Now to the connection with travel. The ACTU recently announced that it would operate for its two million members, a **Travel Grant Scheme**, similar to the one we have been operating for fourteen months. The ACTU has also selected Jetset Tours Pty Ltd to be its official travel consultant, a decision reached by the ACTA in **September 1977**.

It is interesting to find that some of the membership service ideas implemented by YOUR ASSOCIATION in recent times have sufficient merit to be "pinched" by other organisations. It's a nice compliment, isn't it?

Talking of the Travel Grant Scheme, it has already been used by a number of members, each of whom has received a substantial grant to assist with travel costs. The system works only on travel booked direct through Jetset Tours and you MUST identify yourself as a member or family of a member when paying the deposit. A Travel Grant Application form must be completed and signed by the member.

## 1979 to be a BIG year for Travel

The Australian Clay Target Association will promote travel on a much broader scale in 1979. Arrangements are already well in hand for the following tours:

### (a) New Zealand

The 1979 New Zealand National Championships will be conducted at Hamilton on the North Island, from 24th March to 31st March. Your Association has arranged for three parties to attend, one from each eastern port — i.e. Brisbane, Sydney and Melbourne. Costs are shown in an advertisement elsewhere in this issue and include transport between Auckland and Hamilton.

Because accommodation facilities at Hamilton are limited, early booking is advisable

### (b) Singapore

The Pesta Sukan Games will again be held in August in Singapore. The members of the 1978 group enjoyed themselves so thoroughly that the number of places in the 79 group has been doubled.

### (c) USA Grand American Tournament

To cater for the many Australians who have seen the "standard" tourist attractions of the USA but still wish to join an ACTA group visiting the "79 Grand", alternative tours are available. The standard tour of 28 days will follow basically the same plan as this year's successful promotion AND AT THE SAME PRICE (unless International airfares rise) while the alternative will be 30 days including Canada, and the "Deep South" of the United States.

An approximate price for this tour is \$2100.

### (d) Austria, Europe and Great Britain

The 1979 World Moving Target Championships will be held in Vienna, Austria during the last half of August. A group will be organised to take in the Championships and then holiday in many of Europe's most beautiful spots before crossing the Channel into England. After a few days in the United Kingdom, back into Europe and then home. Early indications are that this tour will cover 30 days.

### (e) New Caledonia

It is very likely that the World Championship for Simulated Field Shooting will be held at Noumea next year. The ACTA plans to have a big party travelling to the sixth Open New Caledonian Championships, which will be run concurrently. Will you be there?

It will be clearly seen that there are limitless opportunities to combine a family holiday with some shooting, either as a participant or an onlooker. The staff at the National Office are always ready to assist members who have any queries on these matters.

Remember, making travel arrangements through the Association's consultants, Jetset Tours, not only benefits the Association but also ensures that YOU GET THE PROFESSIONAL ATTENTION YOU DESERVE. ○

# TRAVEL GRANT APPLICATION

Please have this form endorsed by your Jetset Travel Consultant after your travel arrangements have been finalised and are fully paid.

1. I/We acknowledge that .....  
(name of organisation)  
reserves the right to alter or amend these grants in any way and at any time. I/We further agree to refund the grant made to me/us in the event of the travel arrangements listed below not taking place.

.....  
(Signed)

Dept./Inst.....

2. Travellers .....

3. No. Pax .....

Address.....

Post Code .....

I hereby certify that the arrangements have been made, finalised and fully paid for.

4. Departure Date .....

5. Consultant No. — State .....

## OFFICE USE ONLY:

6. Air .....
7. Jetset .....
8. Land (other) .....
9. Sea .....
10. Domestic .....
11. Total Cost .....
12. Travel Grant .....

Signed .....

(Travel Consultant)

A 82

ACTA 78

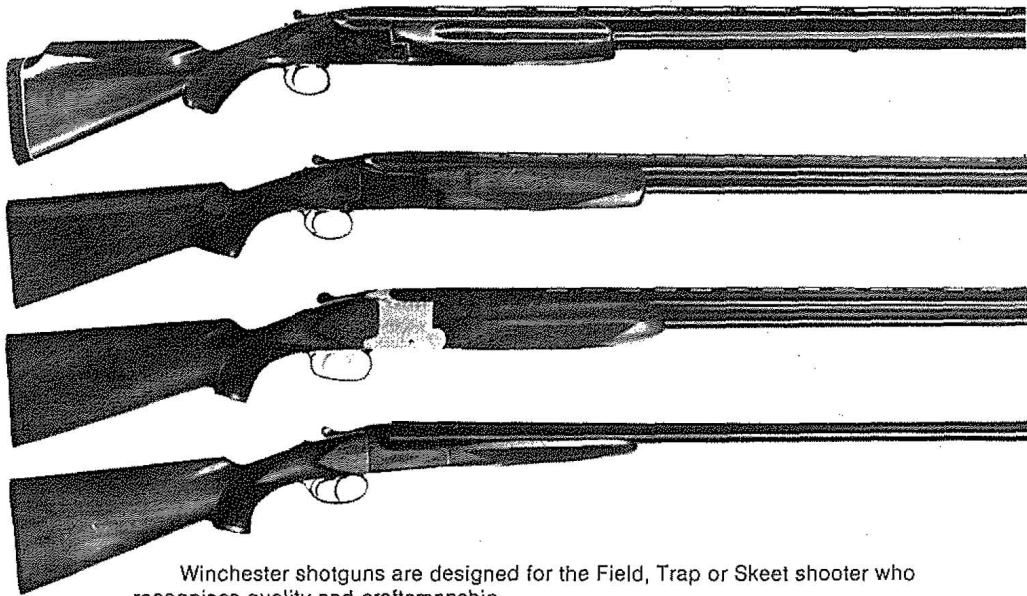

Winchester shotguns are designed for the Field, Trap or Skeet shooter who recognises quality and craftsmanship.

**Model 101. Under and Over.**

Single selective trigger, auto ejectors, chrome lined barrels. Field models 30" and 28" modified and full. 26" improved cylinder and modified.

**Model 96. Xpert Under and Over.**

Featuring ventilated rib, single selective trigger, auto ejectors, walnut stock and fore-end. Available in 28" and 30" Mod/Full, 26" Imp. Cyl/Mod and 27" Skeet 1/Sk2.

**Model 91. Under and Over.**

Black chrome finish—short crisp trigger pull—oil finish stock and fore-end—28" barrels Mod/Full choke—Extractor Model.

**Model 22. Side By Side Double Barrel.**

Black chrome finish for improved rust resistance—Oil finish stock and fore-end—Extractors for the reloaders—Double triggers—Quick pointing 28" barrels Mod/Full chokes.

# Winchester Territory. Your kind of country.

# Senior Federal Government Sports Administrator Addresses National Executive

At the September Executive Committee meeting, the Association took another step in its progress when a senior public service officer addressed the Committee. He was Mr Graham Dempster, who is the Assistant Secretary, Sports and Recreation Branch, Department of Environment, Housing and Community Development. As a measure of the increasing stature the A.C.T.A. is gaining nationally, he made the trip from Canberra to Sydney specifically to talk to the Committee.

He began by apologising on behalf of Mr Ray Groom, the Minister to whom the invitation was originally extended. Mr Dempster spoke on the more recent history of sports assistance policies at a National level. The first ever capital grant for sports assistance from "the Feds" was to Melbourne Gun Club and the Victorian Branch of the Sporting Shooters Association, back in 1973. It was this grant, combined with a State Government contribution and a lot of guts and determination shown by many people that the 1973 World Championships were so successful. Mr Dempster was the "bureaucrat" who initiated the 1973 grant therefore he has had a long standing relationship with the shooting sports.



● Graham Dempster (left) makes a point. Acting Chairman, Ron Porter (centre), and Secretary/Manager, Noel Southey (right).

Mr Dempster then drew some comparisons between the Sports assistance policies of the 72/75 Labor Government and the present Government. One of the biggest changes has occurred in the attitude towards competition aid — funding assistance for State teams, from a Federal source, is now very much a no-no. The Feds' attention is now centred on ONLY National and International levels of competition and our readers will be aware that the Australian Clay Target Association has already been a beneficiary under this policy. Under Labor, due to the program being so new, there was a general goodwill shown towards sport, attached to which there was also a certain level of Government intervention sometimes seen as interference. Under the circumstances evident today, the emphasis is very heavily on sports doing their own thing, establishing their own policies and only in extreme cases would Government consider interfering. One exception to this policy applies to the selection and appointment of full time sports administrators and directors of coaching, which result from Government financial aid. Quite obviously, in these areas, the Departmental offices have an obligation to ensure that taxpayers' money is being used effectively!

The present Government's policies on sports assistance are based on three main objectives, Mr Dempster said. They are:

1. To improve the standards of performance of Australian athletes, and provide them with opportunities to compete at home and abroad.

2. Support National Associations, with the purpose of upgrading the administration and coaching functions to a point where world standards can be achieved.
3. To co-operate at all levels of Government and sports organisations to assess problems and work towards resolving such problems to the benefit of all.

He mentioned here, another difference in policy between Labor and the present Government — this one relates to the use of the Sports Advisory Council. Under Labor, this Council was a fourteen man panel, and its responsibilities included advising the Government on almost ANYTHING TO DO WITH SPORT. Under the present Liberal Government, the Sports Advisory Council consists of six people that advises the Government on the way in which funds should be allocated — a very much narrower remit.

Moving on to funding, Mr Dempster pointed out that in the 1977/78 Federal Budget, \$1 million was allocated for sports assistance. In 78/79 the allocation has been increased by 33 1/3% to \$1.3 million dollars. (Ed note — see report elsewhere in this issue on this subject). He said that in present economic climate, any increase in Government expenditure must be considered as a plus. Mr Dempster pointed out that it was NOT present policy to ever aim to completely fund sport in Australia and acknowledged that sports generally did not want it that way either. There is a certain pride and esteem to be gained from pursuing a policy of self-help and he commended the A.C.T.A. for the willingness it shows to accept the challenge of self-help.

Mr Dempster put heavy emphasis on some of the factors considered by the Sports Advisory Council in its consideration of applications from sports seeking funding assistance. These include:

(a) A strong virile effective National leadership, especially in an administrative sense.

In 1977/78, the S.A.C. recommended the appointment of thirteen full time executive directors. The aim here was quite obviously to improve the professionalism of sports management.

(b) Recognition of a need for change in the structure of the sport — a structure which was found acceptable in 1930 is not NECESSARILY effective in 1978.

(c) The applicant's ability to prepare and perform to a long term development plan. This plan should cover a minimum of five years and should be under constant review.

Mr Dempster complimented the A.C.T.A. on the preparation of its development plan, which compares more than favourably with

Cont'd on page 16.

## Gold Shooting Caps with Australian Badge

**\$5.00** plus postage 40c

Please send cheque  
(made payable to A.C.T.A.)  
for \$5.40 to:

National Office,  
G.P.O. Box 2038S, Melbourne 3001.

— FOR SALE —

## Beretta S58E Skeet Gun

Retails \$825.00 — it's New

**Will Take \$500.00 O.N.O.**

**MUST SELL**

Ph: 03-7621528.

A/H 03-7622588



# How a "Wingmaster" Remington 870 works with you instead of against you.

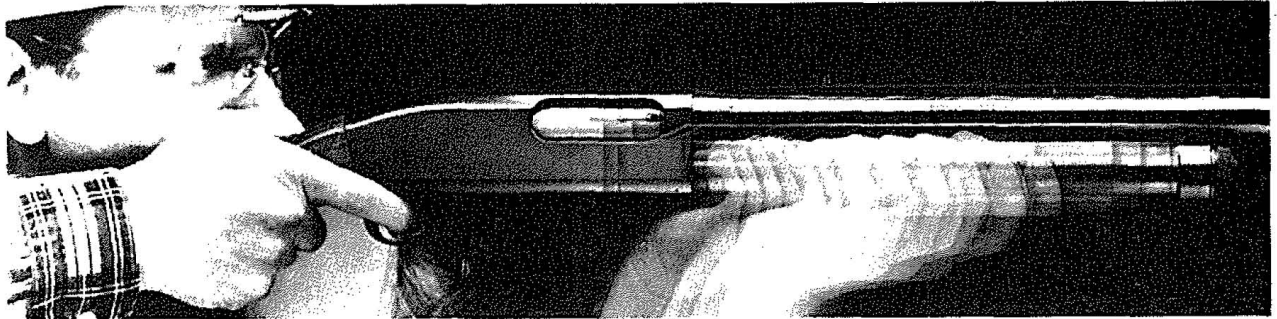

The super-smooth pump action of an 870 actually uses some of the force of recoil to set you up for that quick second shot.

No pump shotgun can completely eliminate the effects of recoil and the pull-push motion it takes to operate the action. But we make a gun that can help you keep them to a minimum—the "Wingmaster" Remington 870, the most popular pump action shotgun in the world.

Remington engineers gave the 870 an action that's smooth as silk. Its strong double action bars do away with twisting and binding, guarantee straight-line pumping, smooth feeding and positive ejection in any kind of weather, under any kind of hunting conditions. And all the metal parts in the action are vibra-honed to an almost mirror-like finish for even smoother operation.

An 870 takes advantage of recoil—instead of letting recoil take advantage of you. Recoil is basically a swift, backward motion. The same kind of motion it takes to work the pump action. With a little practice on an 870, you can work *with* the recoil, make it *help* you pull the fore-end back. When you combine these two motions, you can get your next round chambered quicker. And you'll be less likely to stray off target.

The test of a shotgun's true value is whether it's rugged enough to deliver dependable, reliable performance year after year. An 870 is designed to be rugged every inch of the way. With a highly polished barrel of forged ordnance steel to give you an outstanding pattern consistency. A receiver machined from solid steel for the utmost in safety and dependability. A stock and fore-end protected with Du Pont RK-W, a tough, hard, scratch-resistant finish that'll hold up through years of rough use and rougher weather.

Add the 870's surprisingly affordable price and its wide selection of gauges, barrel lengths and chokes (including extra barrels), and you'll understand why it's unbeatable for quality and value... "right out of the box".

See an 870 at your local firearms dealer now including the popular 'Police Riot Guns' with 20" plain or rifle sight barrels.

They're from Remington — America's oldest gunmaster — and still completely made in the U.S.A.

Find out more about our 870 and our great Remington shells, write for your free full-colour catalogue to — Boustead Trading, P.O. Box 148, Ermington, NSW 2115.

**Remington.** 

Best quality and value. "Right out of the box".

Senior Federal Government Sports Administrator  
Addresses National Executive (Cont'd)



● The attentive foursome from N.S.W. Keith Sim (left), Len Bird, Arch Rowe, Harry Somers (right).

the plans submitted by many of the so-called major sports. The Association's measurable administrative factors such as membership and financial strength are showing increases appreciably in excess of the accepted norm.

On the subject of structure, Mr Dempster used examples from other sports where a fresh approach to management policies is already producing results. It seemed significant that in all examples he mentioned, the Management Group met **REGULARLY** and consisted of between 3 and 5 people. He also placed heavy importance on the problems connected with a lack of a "career path" for people entering the profession of sports management.

Mr Dempster made specific reference to the Association's current plans to update its Constitution and without voicing an opinion, left no doubt in the minds of his audience that changes are vital to the Association's long term future. Still on the subject of structure, the speaker commented that, almost without exception the growth of sports in Australia at the present time had a structure which was based on a **NATIONAL POLICY MAKING GROUP** as opposed to a series of State based groups!! Furthermore, he said that in every case where major policy problems exist, the problems are a result of State bloc-type voting (either directly or indirectly). The successful sports are those which are "big" enough to see beyond State boundaries.

The guest then spoke on some experiences he gained during his visit to Canada for the '78 Commonwealth Games. In Canada, National Sports Associations are actually planning the progress of their top athletes many years ahead, and are offering what we would call sports scholarships to competitors with top potential to ensure that the training program can maintain continuity. In Australia, the forward planning in a competition sense, sometimes extends six months at the most. Mr Dempster drew the analogy of the "cream in the bucket" theory — the cream always rises to the top. His concern (shared by the Executive of the A.C.T.A.) is that in many cases in Australia, the **CREAM DOES NOT GET INTO THE BUCKET!**

Still on the subject of sports development, Mr Dempster talked about the possibilities of using Federal Government policies on cultural exchange visits to organise a visit by a senior sports coach from overseas — alternatively send one of our top coaches or a team of shooters to a country where he or they can offer something (the visit by some Australian shooting coaches to Fort Benning U.S.A. in 1975 may now come under this heading).

Mr Dempster ended his address, by offering the services of his department to assist sporting associations in ANY problems which may arise with Federal Government departments. Some of the likely areas which come to mind include Dept. of Foreign Affairs, Dept. of Administrative Services and Dept. of Customs and Excise.

Mr Dempster's address was received with great enthusiasm by the members of the Executive Committee and many lessons were learned. Perhaps the most obvious message to come from the exercise is that sports management in Australia is undergoing dramatic change, and the Australian Clay Target Association **MUST** ensure that it recognises this need. ○

## A.C.T.A. GROUP IN U.S.A.

(Part 2)

Los Angeles must have the worst Custom Hall of any airport in the world. The 32-strong party which recently represented the Australian Clay Target Association in America arrived in Los Angeles by Air New Zealand flight 506 at about 4 p.m. on August 3rd. At 5 p.m., the passengers had still not disembarked, because of delays caused by the archaic conditions at the airport. A Japan Airlines flight was ahead of our plane and appeared to be the subject of a full alert. Consequently it was 1½ hours before the Aussies got an opportunity to see inside the Los Angeles Airport terminal building.

Fortunately, the Custom Department had been advised that the group was due, in an attempt to avoid any unnecessary hassles over the firearms. As we entered the Customs area, a senior officer was calling for "all members of the Clay Target group to move this way" which ultimately saw us through the crush in a very short time — *no hassles at all!* Nevertheless, it was so crowded in the area that one could easily understand tempers becoming frayed. It took a further 45 minutes for the porter to bring the luggage from the Customs Hall to the ground floor, where a coach was waiting to take the group on the 30-odd mile drive to Anaheim.

The party stayed at the Hyatt House hotel at Anaheim which is on the opposite side of the expressway to Disneyland. The expressway is lined with accommodation houses, all of which appeared to be of a very high standard.

Already we were overawed at the sheer size of everything — for example, Los Angeles has a population of 14 million, which is about the same number as in the **WHOLE** of Australia. The expressways vary from 8 to 12 lanes, and are all constructed of concrete. There are 4000 miles of expressways in the L.A. area alone. The interchanges and cloverleaves are incredible (a word which will appear regularly in this series of reports). Transport terminals and distribution warehouses line the expressways and contain literally hundreds of pantechinon trailers either loading or unloading. To give some idea of the density of vehicles there is a motor car to every 2½ adults.

The Anaheim Hyatt House was only two storeys, which set it apart from most of the other hotels. However, it contained 230 rooms and a total of 790 beds — a hotel of very high standards. As was to become the accepted thing during the tour, we placed the firearms in the hotel security room to ensure their safety. This gave the shooters in the group greater ease of mind as this was to be our home for three days.

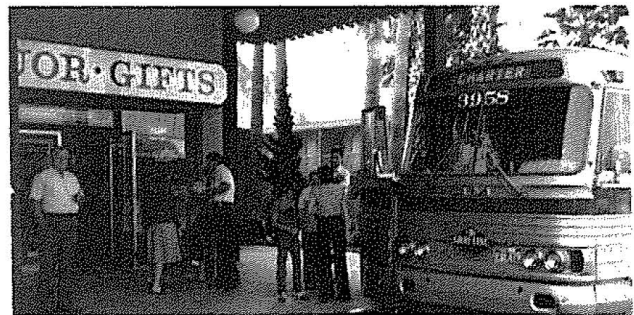

● Ron Porter (left) with others of the group about to board the coach for Universal Studios. This photo shows the outside of the Hyatt House Hotel, Anaheim.

When the National President entered his room, he was delighted to find an arrangement of flowers and a bottle of iced champagne thoughtfully placed there to welcome him by Roy and Betty Ann Foxworthy, who were to be of tremendous assistance to us during the remainder of the tour. (Betty Ann is the editor of the American magazine **TRAP & FIELD**). However, President Ern found it difficult to get "starters" to assist him to demolish the contents of the bottle, as most of the crew had already gone to Disneyland.

Although almost everybody believes that they know about Disneyland, one cannot appreciate the complexity of it without having been there. The first shock to the system is experienced when you enter the car park. The park covers 160 acres, and holds 118,000 cars, including rows and rows of motor homes and tourist buses.

Cont'd on page 18.

# PRICES

# CRASH!

## CUSTOM

### High Performance

## 12g Cartridges

### USED TO WIN:

Gold Medal -  
Sth Pacific C'ships  
Silver Medal -  
New Zealand  
ISU Skeet C'ship  
1977 Commonwealth  
Skeet C'ship.

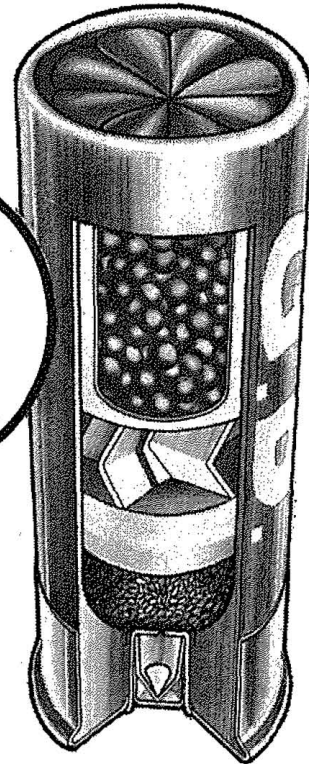

• THE CASE IS ONE PIECE COMPRESSION FORMED AND MANY TIMES RELOADABLE!

• New Case Custom Loaded Shotshell • An all new cartridge featuring a many times reloadable case • The all brass head reduces to a minimum the need to resize • The use of modern clean and fast burning powders ensures a very high performance • All shot sizes available.

## "G.B. CUSTOM PUTS PERFORMANCE IN YOUR GUN"

### GUNS

Specialist in all High Grade Trap & Skeet Guns including Browning, Miroku, Winchester, Franchi, SKB, Perazzi.

### RELOADING EQUIPMENT

George knows the answers here too. Inspect and buy at fully competitive prices from a full range of reloading components including the **ELEY MATCHED COMPONENTS** for your **NOBEL POWDERS**. Full stocks of Pacific, Bear and MEC Reloading and Spares and Accessories.

### RECOIL REDUCERS

Don't suffer the effects of RECOIL. Fit an **EDWARDS RECOIL REDUCER** and get headache-free shooting — Now \$32.

• **JUST ARRIVED!!**

The new **FRANCHI Trap & Skeet Guns** . . . **BARRAGE, GRAND PRIX & DRAGON.**



# GEO. BIGGS LOADING SERVICE

*For complete and Personal Service*

4 HUGH STREET, KNOXFIELD, VICTORIA, 3180. TEL: (03) 221 2748

**AUSTRALIA'S ONLY CUSTOMISED GUN AND CARTRIDGE BUSINESS  
OFFERING SPECIALISED GUN FITTING SERVICE**

## A.C.T.A. Group in U.S.A. (Cont'd)

Every attraction within Disneyland is a show on its own, and one should provide for at least three days and nights to see through it thoroughly.

The following day (Friday) a coach arrived at the Hyatt House at 8 a.m. to take the party on what was listed as a 7 hour tour of downtown Los Angeles and Universal Studios (one of the world's major movie production "factories"). Driver Rick Crane of Grayline proved to be a most entertaining guide and the day developed into a most enjoyable experience with the tour concluding at around 8.30 p.m. about 7 hours late. The extra time was taken in visting the Mexican area of L.A. known as Olvera Street, where California signed its independence from Mexico. Many of the gang took full advantage of the opportunity to buy leather goods and silver items, all at very realistic prices. Rhonda Porter, daughter of National Vice President, Ron Porter, bought herself a silver embroidered sombrero, about 30 inches in diameter. Some of us felt it would have suited Ron better.

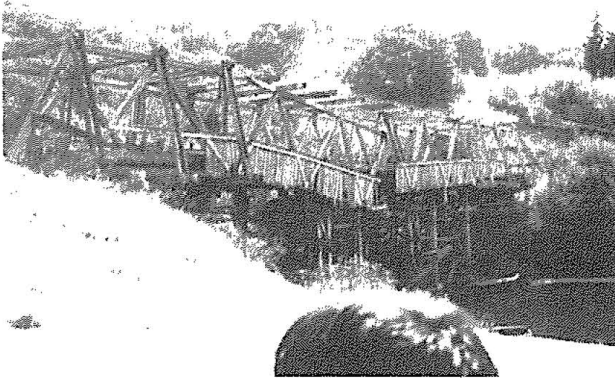

● An "OLD" crumbling railway bridge fully operated by hydraulics.

A musical group provided street music and it wasn't long before many of the Mexicans were giving an impromptu dancing exhibition — none of the Aussies joined in (this situation changed dramatically later in the holiday!)

Earlier in the day, everybody had thoroughly enjoyed a guided tour through Universal Studios, a film-making complex covering 400 acres. Rob Donovan of Toowoomba (soon to become known as "Scoop" because of his "talent" with a camera!) put on the star turn of the day by being selected to participate in a "Bionic Woman" experiment. After being fitted with a special bionics pack, Bob was asked to kick the front tyre of a standard Chevrolet utility. He was rather hesitant, in view of the fact that he was wearing Japanese Shooting Boots (thongs) but after getting a rousing cheer from the many hundreds in the audience finally swung his foot cautiously at the tyre. No one was more shocked than Rob when the tyre INSTANTLY deflated as he made contact. Filled with new found confidence, he then enthusiastically rose to the occasion when invited to try and lift the vehicle off the ground. He performed this task with ease, and proudly accepted the accolades of the overawed audience. It was all a great exhibition of the ingenuity of the film makers.

During the downtown Los Angeles tour, we visited the famous Hollywood Bowl, one of the largest entertainment centres in the world. It has a seating capacity of 150,000 people and has been the venue of many of the world's greatest entertainment shows.

The group was taken through the "big name" area of Beverley Hills and saw many of the "grand" homes of the movie stars. Ostentation is the name of the game and the glamour of the area certainly gets to the visitor.

Lunch was taken at a giant bazaar area called Farmers Market, which is recognised as one of the most comprehensive market places in U.S.A. Again, much of the tourists' money changed hands and already one or two had discovered a need for an extra suitcase, not the least of all being Rhonda Porter with her sombrero.

The second full day on U.S. soil was Saturday, and this was the official day for Disneyland. Lorraine and "Buster" Schmidt of Cunnamulla, Queensland, accompanied by Beth Catling of Katanning, W.A., decided to visit San Diego and Tijuana, while most of the others took in the excitement of Disneyland. Graham Appleby

and John Hutchings were a little late rising today while "Scoop" Donovan had to return to bed with a "slight stomach upset". Perhaps someone fed them a bait on the previous night?

One of the most impressive things about Disneyland is its cleanliness. On this day, approximately 500,000 people passed through the turnstiles, yet the grounds were kept spotlessly clean all day! (Imagine how much easier life would be at Australian Gun Clubs if we could develop the habit of putting our rubbish into bins!) The Americans are very experienced at moving people — with a population of 230 million they have to be.

Crowd control at Disneyland is wonderful to see. Barriers consist of ropes attached to metal stands and are moved about to suit the particular requirement at the time. Thus, queues or lines as they are called in U.S.A. take up a minimum of ground space. Attendants have people moving all the time, which results in a minimum of waiting time, even at the most popular attractions.

The two highlights of our trip to Disneyland were the parades — one in the day and one in the night. 1978 is Mickey Mouse's 50th birthday and all the celebrations revolve around this theme.

The night parade is called the "Electric Light Parade" and is an incredible series of floats depicting various nursery rhyme scenes done in literally millions of small globes — truly a magnificent sight. At the conclusion of the parade, the crowd was treated to a very "American" fireworks display. American, because all of the

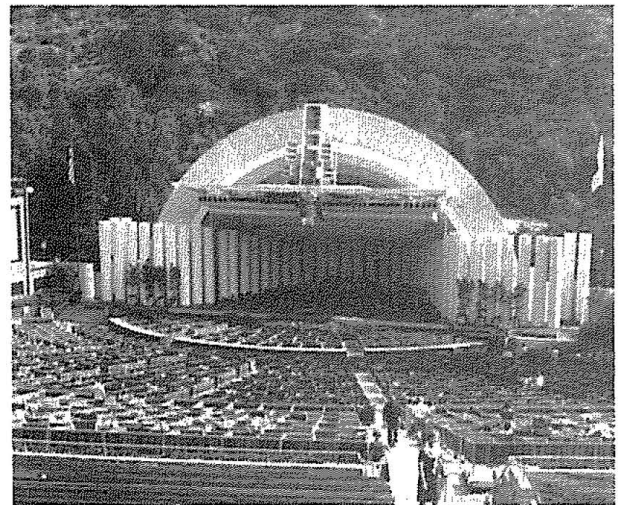

● Hollywood Bowl — Los Angeles.

fireworks exploded into colour which were either red, white or blue. Although we all accepted that U.S.A. is the home of the unusual, the sight of an airplane towing a box kite containing a moving illuminated digital sign advertising a motor dealer still took us by surprise. At 9.30 p.m. at the height of the Electric Light parade, the timing of the flight was perfect.

It was well after midnight when most got to bed, after making sure that the "Mexico visitors" had returned safely. Short nights were already becoming the norm; for some, shorter than others (weren't they Graham?)

Sunday was the day that we had to depart for Las Vegas. We were scheduled to leave Orange County Airport at 9.30 a.m. which meant leaving the hotel at 8.00 a.m. Because there had been some doubt about the bus which was booked to take the group to the airport, we confirmed it the night before — guess what — we finished up with two coaches.

The party arrived at Orange County Airport after a twenty mile drive, in plenty of time to catch the "Flying Banana" the colloquial name for aircraft operated by Hughes Airwest, because of the distinctive "kak yellow" the planes are painted. It were here that the first minor hassle developed over handling of the firearms. A booking agent asked to inspect the contents of each of the gun cases, but after going through the first three, decided that the remaining eight would be O.K.

Next month, we cover the visit to Las Vegas, the gambling capital of the world, and the home of Bob Taylor's Trapshooting Country Club.

# BIG INTERNATIONAL SHOOTING COMPLEX LAUNCHED IN CANBERRA

The Canberra Lakeside International Hotel was the venue for one of the biggest shooting promotions yet seen in the Australian Capital Territory when on the 14th September the A.C.T. and District Shooting Association publicly launched its proposal for the Canberra International Shooting Complex. The power behind the proposal is Mr Val Paral who is one of the most dynamic and enthusiastic people one could ever meet. He has thrown off the lethargy that afflicts so many sports administrators and has proved with the assistance of his enthusiastic committee that obstacles are made to be overcome.

Eighteen months ago Val Paral approached the Australian Shooting Association with a proposal that it consider the development in Canberra of an International Shooting Complex. The delegates at that meeting were too short-sighted to realise the long term benefits to accrue to shooting in Australia from such a development and virtually told Paral to "go roll his hoop". Fortunately for the shooting sports, Paral was not at all dissuaded by this negative approach and simply devoted his efforts in other directions. As a direct result of his tenacity the A.C.T. and District Shooting Association was able to promote a public dinner at the Canberra Lakeside International Hotel which was a sell-out — there were 220 paying guests — at which a firm proposal was presented. The guest list at the dinner included a number of prominent people from the Canberra area together with the Secretary/General of the Australian Olympic Federation, Mr Julius Patching.

Because of the Olympic connections with shooting, Mr Patching was invited to address the gathering and during his talk he strongly supported Australia's need for a world class competition shooting complex. He pointed out that both Sydney and Melbourne were rumoured to be considering making applications for the 1988 Olympic Games, there was a strong chance that Australia would be

selected to host the 1986 world shooting championships and should either of those events be allocated to Australia we would be caused great embarrassment through having no venue for the shooting matches. Patching, who is probably the most widely experienced sports administrator in Australia, pointed out that *shooting is in the top six Olympic sports*. He said it was refreshing to see the foresight of Val Paral and his Committee in recognising the importance of providing an opportunity for the community to use firearms under safe conditions. Furthermore, when it is complete, the planned complex will elevate Australia's standing with overseas countries quite dramatically.

In his profession as Supervisor of Recreation for the City of Melbourne, Patching recently went on a study tour which took in Switzerland. In that country every home has a firearm. Furthermore, in every community centre was to be found a miniature rifle range. Communities can exist compatibly with firearms — *there is nothing wrong with the firearm, it is the people who use them who are at fault*.

Mr Patching went on to say that in spite of views expressed by some of Australia's "leading" legislators, there is no doubt that legislative control will NOT prevent gun related crimes. Heavy penalties must be imposed to act as a deterrent, while the responsible firearms users are left to enjoy their recreation.

In closing his address, Judy Patching said that the foundation membership of the complex was a bargain at \$150 per person (or \$200 per family) and strongly recommended that all present should take advantage of the investment opportunity.

Senator John Knight, of the Australian Capital Territory then addressed the meeting and expressed the appreciation of all present for the effort put in by Judy Patching in promoting amateur sports in Australia. The Senator pointed out that he is used to being "lobbied" — usually the lobbying takes the form of a few people visiting the politicians office. But to pack 220 people into Canberra's plush Lakeside Hotel, he said, was taking lobbying to a new professional level.

The Senator acknowledged the importance of training the community in the safe handling of firearms — the complex will fill a very genuine need in this area. He pledged his support for the project and promised to use whatever influence possible on his colleagues.

Cont'd on page 21.

## PERAZZI . . .

The competition gun that gives you the extra satisfaction you want and deserve to get from your sport.

Mod. MX8 in 27½", 29½" and 32" barrels with & without screw-in chokes -- for -- SKEET -- TRAP & TRENCH.

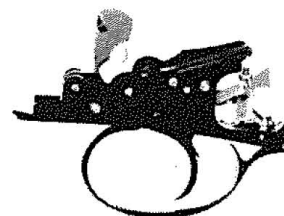
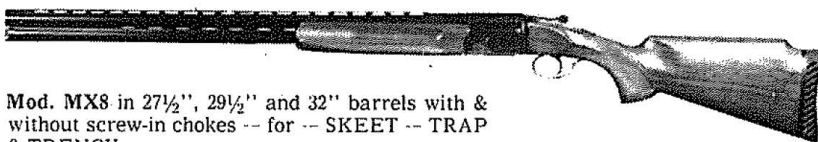

MX8 Detachable Trigger Assembly

"The Gun with the built-in expertise which means the difference between that extra target you gain, which otherwise could have been lost. Isn't it true most times you say 'I only need that one?'"

It's worth doing something about it **now**. After all, you spend big money on your shooting. The cost of the gun in comparison is minimal and above all becomes an **investment**, and what about the experience — "It's Great!"

There's no point in denying yourself what you want and deserve from your sport — satisfaction of achievement is the ultimate goal and besides, are you not doing yourself a favour?

**BUY NOW AND MOST CERTAINLY BE WAY AHEAD IN BOTH VALUE AND PERFORMANCE**

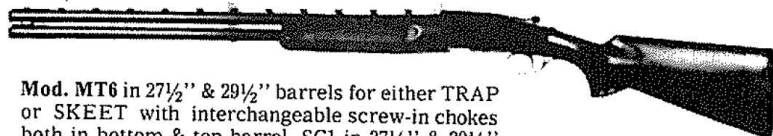

Mod. MT6 in 27½" & 29½" barrels for either TRAP or SKEET with interchangeable screw-in chokes both in bottom & top barrel. SC1 in 27½" & 29½" for SKEET & TRAP. SC3 in 30" barrel with screw-in choke, bottom barrel only.

**TONY YOZZI SPORTS**  
460 William St. (Cnr. Brisbane St.)  
PERTH 6000. W.A.  
328-4981



# AUSTRALIAN NATIONAL CHAMPIONSHIPS



**ANSETT**  
AIRLINES OF AUSTRALIA  
The Sports Airline

**GRIFFITH GUN CLUB 7th - 13th MARCH, 1979**  
Pre-Shoot - 3rd to 5th March  
Practice Day - 6th March.  
Championships - 7th to 13th March



Ansett Airlines have been appointed Official Accommodation Agent and Carrier by the Australian Clay Target Association.

## BOOK EARLY TO AVOID DISAPPOINTMENT

Due to the limited accommodation available in Griffith, it has been necessary to obtain accommodation in Whitton and Leeton, approximately 60 kms from Griffith.

**Motel Accommodation** — with private facilities — R/O rates unless otherwise stated.

Caravilla Motel, Griffith.  
\$19.50 SGL, \$24.50 Stan. TWN/DBL.  
\$27.00 DLX. TWN/DBL.

M.I.A. Motel, Griffith.  
\$24.00 DBL, B/BFAST.  
\$31.00 DBL & SGL, B/BFAST.

A Line Motel, Griffith.  
\$20.00 TWN/DBL, \$23.00 TPL.  
\$24.00 - \$26.00 Family Rooms.

Acacia Motel, Griffith.  
\$25.00 TWN/DBL, \$28.50 TPL.  
\$27.50 DBL & SGL.

Riverina Motel, Leeton.  
\$18.50 SGL, \$25.00 DBL/TWN.  
\$29.00 TPL.

Leeton Gardens Motel, Griffith.  
\$24.00 DBL.  
\$29.00 TPL.

Griffith Hotel/Motel, Griffith.  
\$17.00 SGL, \$24.00 DBL, \$30.00  
TPL, \$39.00 - \$43.00 Family Rooms.

**Hotel Accommodation** — Without private facilities.

Area Hotel, Griffith.  
Ricebowl Hotel, Whitton.

\$12.00 P/P, B/BFAST.  
\$12.50 SGL, \$20.00 TWN/DBL,  
including Breakfast.

Leeton Hotel, Leeton.  
Wade Hotel, Leeton.

\$10.50 P/P, B/BFAST.  
\$11.00 SGL, \$20.00 TWN/DBL,  
including Breakfast.

**On-Site Caravans** — Limited four and six berth vans available at Griffith Caravan Village and Leeton Caravan Park. Approximately \$10.00 to \$12.00 for two persons. (Not all vans supply cutlery and cooking utensils). All prices are current and subject to alterations. Deposit of \$20.00 per room is required.

For accommodation reservations, complete this form and return it to:

**Group Travel Department,  
Ansett Airlines of Australia, Oxford Square, Darlinghurst, N.S.W. 2010.**



Name: BRYAN DAFFERTY

Street: 7 GERRARD STREET Suburb: MARRIHOPE

Postcode: 2430 Telephone: 054 611379

As accommodation is limited, list first and second preference.

First: A. Line Motel Griffith Second: Riverina Motel Leeton

Number of Rooms Required: CARAVILLA MOTEL GRIFFITH

SGL.  TWN.  DBL.  TPL.  FAMILY

Dates Required: IN: 6/3/79 OUT: 13/3/79

Air Travel Required: YES  NO  (Please make cheques payable to Ansett Airlines).  
Deposit Enclosed \$ 20.00

Please return this form as soon as possible as accommodation cannot be held later than December 31st, 1978.

## Big International Shooting Complex Launched in Canberra (Cont'd)

Val Paral then spoke and emphasised the need to demonstrate a self help motif. He believes that if stage one of the project can be achieved by the family then stage two and three will be possible because of the injection of outside funds. Many of those in attendance took the opportunity to take out foundation membership of the complex.

Before the evening finished, Peter Anderson, the Training Co-ordinator from Australia's recently returned Commonwealth Games Shooting Team, spoke on behalf of those members of the forthcoming World Championships Team who are resident in and around Canberra. These include Maureen Hill (Small Bore Rifle), Greg Colbert (Pistol Shooting), Jim Ellis (Trap) and Dr Mike Kneebone, Team medical officer. Peter made particular reference to the enormous costs in terms of both time and money confronting team competitors these days — however he acknowledged that to gain a position in a world championships representative team is a fitting reward.

The A.C.T. and District Shooting Association has certainly set the pace in terms of developing new integrated facilities and one hopes that the Australian Clay Target Association can follow suit. (Staff Reporter) ○

## MIROKU Under & Overs

### SPECIAL LOW PRICES

- MODEL 800 with 12 mm Rib, 30" barrel ½ and full \$475.00
- MODEL 800 SKEET, Broad Rib \$475.00

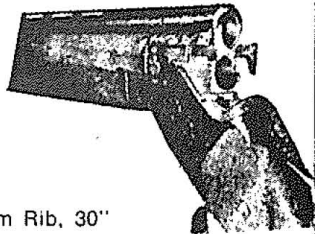

## SPECIAL OFFER BROWNING

Under & Over at Big Discounts

ALL GUNS LISTED ARE NEW

- A1 SPL. TRAP - 28" only Broad Rib or No. 6 Rib 12 mm WELL BELOW TODAY'S COST \$1280.00
- B2 (Model D Grade) Trap Gun 28" barrels. ONLY A FEW AVAILABLE AT THIS PRICE OF \$1895.00
- BROWNING A2 Skeet - List Price \$2,322.00 - Our Price \$1,295.00
- BERETTA S.O.4 Side Lock Ejector Trap Gun, 29" barrels - List Price \$3,800.00. OUR PRICE \$2,500.00
- BERETTA S.02 Skeet Guns to special order only - Big Discount.
- BERETTA 57E Trap Gun - Special Offer \$498.00
- WINCHESTER - Latest Model Pigeon Grade Ejector Model 10184 with 12 mm Rib - Our Price \$498.00
- MERKEL - Just Arrived - Under & Over Model 201 Ejector with extra set of Skeet barrels - Discount Price \$2560.00
- MERKEL Side lock ejector Under & Over. Beautifully engraved, deep subject engraving with genuine gold dogs, etc. It's a chance in a lifetime to purchase a gun like this \$4950.00
- PERAZZI - Just Arrived. Models S.C.3 - MT6 - M.X.8 - Mirage. Send for discount list and illustrated pamphlet.

*Gun Repairs by Experts*

## EVANS & BALFOUR PTY LTD

269 LITTLE COLLINS ST., MELBOURNE, 3000  
Telephone (03) 63 7841, 2 & 3  
After Hours Les Turner 859 4781

# OLIMPYC TARGETS

12 Rosebery Street, Balgowlah, NSW 2093  
Phone (02) 94 6607

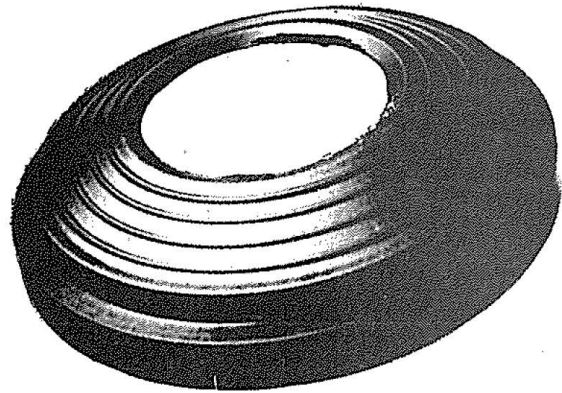

Black & Colored Targets Available  
Buy Direct from Manufacturer or Agent. Very  
Competitive Prices.

### AGENTS

#### Victoria:

Mr G. Ash  
35 Wallace Ave.,  
Frankston, Vic. 3199  
(03) 7832277  
(03) 7894661 A.H.

#### South Australia:

Mr Phillip Mules  
Super Elliots Pty. Ltd.  
200 Rundle Street,  
Adelaide, S.A. 5000  
(08) 2233946

### RIVERINA

Wagga Boat & Sports Store  
55 Murray Street,  
Wagga Wagga, N.S.W. 2650  
(069) 213894

## Why Not Give Us A Go. These Clubs Do

CESSNOCK CITY GUN CLUB	ETON-MACKAY GUN CLUB
CONDOBOLIN GUN CLUB	MT ISA GUN CLUB
COROWA GUN CLUB	SILKWOOD GUN CLUB
COWRA GUN CLUB	BENALLA GUN CLUB
DORRIGO GUN CLUB	FRANKSTON AUST. G.C.
DOWNSIDE INTER. GUN CLUB	WANGARATTA GUN CLUB
GUNNEDAH GUN CLUB	ALEXANDRA GUN CLUB
GUYRA GUN CLUB	BUTE GUN CLUB
HAWKESBURY GUN CLUB	MT GAMBIER GUN CLUB
LEETON GUN CLUB	SOUTH AUST. GUN CLUB
MARCONI GUN CLUB	WHYALLA GUN CLUB
N.S.W. GUN CLUB	WILKAWATT GUN CLUB
NEWCASTLE GUN CLUB	CUNDERDIN GUN CLUB
ORANGE GUN CLUB	GERALDTON GUN CLUB
QUEANBEYAN/CANBERRA G.C.	ARNHEM GUN, PISTOL & RIFLE CLUB INC.
TAMWORTH GUN CLUB	DARWIN GUN CLUB
TAREE/WINGHAM G.C.	McARTHUR RIVER G.C.
UPPER HUNTER GUN CLUB	TENNANT CREEK
WAGGA GUN CLUB	CLAY SHOOTERS
CAIRNS & DIST. GUN CLUB	

# INTERNATIONAL SHOOTING SCENE

The BIG NEWS this month revolves around Australia's clay target shooters competing at Seoul Korea, in the 1978 World Shooting Championships.

Jim Ellis has produced another of his remarkable "under pressure" performances to win a Bronze Medal in the Olympic Trench match with a score of 195-200. Only one target behind Jim, but in sixth place overall, was Terry Rumbel on 194-200.

Australia's development of international style clay target shooting will be greatly accelerated by these performances, as, to use a worn out cliché, nothing succeeds like success.

After the first two days of the Trench match (at the end of the first 150 targets), Ellis was tied on 148 with another competitor for FIRST PLACE, and Rumbel was equal third on 147. Each withstood the enormous pressure of the last fifty targets to record Australia's best ever performances in world competition. The other two members of the Trench Team, Neil Berry and John Porter gained considerable valuable experience which will equip them well to be contenders for places in the 1980 Olympic Games team.

The skeet team also performed very creditably, with Alex Crikis being the best Australian with a score of 189-200. Newton Thomas was overheard saying to Alex "For some time, you have been a world-class shooter — now you are a world-class COMPETITOR!" High praise, indeed! John Summers recorded 182-200 and Ian Hale carded 180-200, each a worthwhile performance. Fred Guyatt, the baby of the skeet team (in an international experience sense) although overawed by the congregation of such a large number of competitors battled on well to finish with a 170-200. Unfortunately there has been no official news received from Korea on the team's overall performances, and hopefully a more detailed report will be included in the December issue of C.T.S.N.

## "R & L SKY" OLYMPIC TRENCH POSTAL TEAM'S COMPETITION

Almost two years ago, Ron and Leonna Sky of Taree-Wingham Gun Club, donated a Perpetual Cup for postal competition between trench teams representing ANY club in Australia. The Cup was presented to the 1978 winners, A.C.T. International Gun Club of Canberra, at the conclusion of the National Trench Championship. Harry Somers who accepted the trophy on behalf of the winning Club, expressed his disappointment at the poor entry in the match. Very few teams recorded scores and this seems contrary to the enthusiasm shown by trench shooters in Australia.

So, come on you trench shooters! Scores can now be recorded for the 1979 competition — conditions are as follows:

1. To be shot over a 100 target event.
2. Teams of 6-5 scores to count.
3. At least 3 members of each team must be registered with the Club for which they shoot. 3(a) Limit of 3 teams per Club.
4. Teams must be shot and scores sent to the I.S.U. Subcommittee one month prior to the National Championships.
5. Score sheets to be signed by referee and secretary and submitted to the sub-committee within one month of the date of the shoot.

6. Teams must shoot at a recognised Championship on a 15 trap I.S.U. Olympic Trench layout.

7. Open to all affiliated Clubs in Australia that care to field a team.

8. Cup to be presented at Australian National Trench Championship each year. The Club who holds the cup is responsible for the cup being brought to National Championship in good order and condition.

9. Rules may be altered at the discretion of the I.S.U. Subcommittee.

## MEETINGS OF SHOOTERS INTERESTED IN INTERNATIONAL DISCIPLINES

During the National Trench Championship held at International Gun Club, South Australia, the opportunity was taken to hold an informal meeting of competitors to seek advice on development plans for the sport. One of the things to come out of the meeting was a decision to promote Ball Trap competition in Australia as an introduction to Trench Shooting.

In line with this decision, Ball Trap championships have been added to the Commonwealth and State roster — the 1979 Commonwealth Ball Trap Championship has been allocated to Victoria.

Talking of Ball Trap shooting, Metropolitan Clay Target Club in Victoria is in the final stages of installing such a facility, which will be tested for the first time during the Grand Prix Carnival to be conducted from November 4th to November 7th.

Switching back to Inter. Gun Club, it has just successfully negotiated the purchase of two Beretta-Fiocchi hopper-fed skeet traps from the Sporting Shooters Association. The installation of this equipment at the Club's Virginia ground will serve to promote the growth of I.S.U. skeet in that state. ○



• R. & L. Sky Perpetual Trophy.

# JUST ARRIVED... PERAZZI

## NEW SHIPMENT PERAZZI

World famous shotguns.

A gun of distinction . . . used by champions.

These guns will lift the ability of shooters generally to achieve better results . . .

- Models available include: MIRAGE, MX8, MT6, SC3, SC0.

**EVANS & BALFOUR PTY LTD** 269 Little Collins Street  
MELBOURNE 3001

Spare Parts and Service always available.

(03) 63 7841 - 42 - 43 Trapshooter's Discount available.

FREE  
PERAZZI  
ILLUSTRATED  
LEAFLET  
SEND  
NOW!



# COLLECTORS' COLUMN

with Paul Gribben (Cosgrove Gun Club)

## Her Majesty's Guns

Part 1

It is just ten years since I saw this remarkable collection of firearms at the Tower of London.

"By gracious permission of Her Majesty The Queen, a selection of finest sporting arms in the Royal Collection at the Windsor Castle, had been lent for temporary exhibition in the Armouries of Her Majesty Tower of London."

I spent two days at the Tower and brought home with me a detailed description of some of the pieces which had the most appeal. I consider the experience most valuable, and the memory lingers.

I have not sought Royal permission to describe the Royal Arms to our readers, and just hate to think what may happen if I am summoned at Royal Command, back to the Tower to pay a short visit to the historic chopping block!

Generally the Tower of London is used for the housing of the British Military Collection which contains an example of just about every model of firearms the "Brits" used from the matchlock to the modern breechloader. It was this Collection I intended to study, but to my delight the Royal Collection from Windsor Castle was on show — this was for the first time ever.

The Collection dates back to the time of Henry VIII 1509-1547 who imported quantities of Arms for his Army from many places in Europe, as well as technicians to teach the Art of gun making and War to the Englishmen.

As well, Henry VIII ordered guns simply for their beauty and novelty, and at the time of his death had amassed a fine collection of arms of all kinds.

Charles II and Queen Anne also had an interest in such things, both made gestures of firearms and armoury in order to obtain favours from other Rulers, and doubtless received like gifts in return.

During the reign of the three Georges, the collection gradually grew in importance, but the Prince of Wales before he became King George IV made the greatest contribution, as he and his brothers travelled widely, squandering the Nation's money on wine, women and song, not forgetting vast quantities of the most favoured military and sporting guns, swords and uniforms made by the best makers in Europe and Great Britain.

In 1787 the Government of the time settled debts of the young Princes amounting to no less than the astronomical figure of 659000 Pounds. Prominent among the debtors were some of England's top gun makers, as the Collection contains magnificent pieces from such makers as Henry Nock, John Manton, Robert Wogden, Durs Egg, John Knobley; all apparently made regardless of cost.

The memory of one by Durs Egg remains with me still, a fine double barrelled Flintlock gun dated 1790 fitted with steel locks, inlaid with gold floral decoration and hunting scenes, and the maker's name impressed into egg shaped gold labels. The pans are gold lined, the brown twist barrels are decorated with the Prince of Wales Coat of Arms in gold. The rib has 'DEGG LONDON' in gold letters, gold bead foresight, the barrel tang inlaid with gold floral and lowered to act as a rear sighting channel. The stock of walnut is beautifully figured and neatly checkered at the wrist, and is decorated with the Prince of Wales feathers plus silver mounts of hunting scenes on both sides. The butt plate has the makers name in gold; altogether a richly ornamented work of art costing then 57 Pounds 15 Shillings.

But for the sheer extravagant beauty, the double barrelled Flintlock gun by John Knobley London swordmaker turned gun maker, would be one of the outstanding firearms in the world if judged on ornamentation only. The blue of the locks and barrels, still after 200 years, shone with the brilliance of a new firearm; lock decoration was gold cannon and lions, both the cocks were signed by the maker in gold.

With its cheek rest covered in green velvet, all silver mounts hallmarked for 1789-90 with the silver artist's famous initials MB (Moses Brent). The brown twist barrels profusely decorated at breech and muzzle with gold ornament and gold bead foresight.

Cont'd on page 52.

# BLUE DOT

is now used  
by all these clubs!  
They must be good!  
They're the right price  
and top quality.

N.S.W. Gun Club  
Melbourne Gun Club  
Metro Gun Club  
Bundaberg Gun Club  
Burdekin Gun Club  
Cairns Gun Club  
Charters Towers Gun Club  
Condamine Gun Club  
Alexandra Gun Club  
Apsley Gun Club  
Ararat Gun Club  
Katherine Gun Club  
Bairnsdale Fld. & Gme. Assoc.  
Australian Gun Club  
Wyong Gun Club  
West Wyalong Gun Club  
Yamba Gun Club  
Grafton Gun Club  
Lismore Gun Club  
Downside Internat. Gun Club  
Cunnamulla Gun Club  
Dysart Shooters Gun Club  
Gympie Gun Club  
Ipswich Gun Club  
Cobar Gun Club  
Kallangur Gun Club  
Maryborough Gun Club  
Mt. Isa Gun Club  
Rockhampton Gun Club  
Roma Gun Club  
Scrubby Creek Gun Club  
South Burnett Gun Club  
St. George Gun Club  
Sunshine Coast Gun Club  
Tambo Gun Club  
Terranora Lakes Gun Club  
Toogoolawah Gun Club  
Toowoomba Gun Club  
Townsville Gun Club  
Wandoan Gun Club  
Warwick Gun Club  
Weipa Gun Club  
Gladstone Gun Club  
Gold Coast Gun Club  
Ravenshoe Gun Club  
Nine Mile Gun Club  
Barmera Gun Club  
Bute Gun Club  
Darwin Gun Club  
International Gun Club  
Mallala Gun Club  
Mannum Gun Club  
Millicent Gun Club  
Mt. Gambier Gun Club  
Wilkawatt Gun Club  
Pt. Augusta Gun Club  
Pt. Pirie Gun Club  
Robe Gun Club  
South Australia Gun Club  
Whyalla Gun Club  
Wakene Lowbank Fld & Gme. Assoc.

Victorian Fld. & Gme. Assoc.  
N.S.W. Fld. & Gme. Assoc.  
Wagga Gun Club  
Wagga Fld. & Gme. Assoc.  
Lake Albert Fld. & Gme. Assoc.  
Perth Gun Club  
Warrburry Skeet Club  
Eastern Goldfields Gun Club  
Colac Gun Club  
Cosgrove Gun Club  
Foster Gun Club  
Hamilton Gun Club  
Korumburra Gun Club  
Mansfield Gun Club  
Mildura Gun Club  
Mornington Gun Club  
Morwell Gun Club  
Mt. Bogong Gun Club  
Sebastopol Gun Club  
Shepparton Gun Club  
Tatura Gun Club  
Puckapunyal Army Gun Club  
Wangaratta Gun Club  
Woods Point Gun Club  
Warrackbeee Gun Club  
Corio Bay Gun Club  
Birchip Gun Club  
Donald Gun Club  
Dimboola Gun Club  
Toolooloona Gun Club  
Lang Lang Gun Club  
Finley Gun Club  
Dubbo Gun Club  
Goulburn Gun Club  
Griffith Gun Club  
Hawkesbury Gun Club  
Gunning Dalton Gun Club  
Gunnedah Gun Club  
Illawarra Gun Club  
Inverell Gun Club  
Kempsey Gun Club  
Leeton Gun Club  
Lismore Gun Club  
Moree Gun Club  
Narrabri Gun Club  
Narrandera Gun Club  
Newcastle Gun Club  
New England Gun Club  
Pt. Macquarie Gun Club  
Queenbeyan Gun Club  
Sutton Forrest Gun Club  
Tarnworth Gun Club  
Taree Wingham Gun Club  
Tumut Gun Club  
Upper Hunter Gun Club  
Wakehurst Gun Club  
ACT Internat. Gun Club  
Albatross Gun Club  
Bathurst Gun Club  
Brewarrina Gun Club  
Broken Hill Gun Club  
Hobart Gun Club

Does your club use them?  
If not contact:

## BLUE DOT TARGETS

P.O. BOX 178, CARINGBAH, N.S.W., 2229  
Tel. (02) 524-0655. A/H. Phil Jost (02) 524-3223

MELBOURNE: Rupe Henwood  
253 Blackburn Road Blackburn, VIC., 3130 (03) 878-4232  
BRISBANE: Bill Stevens  
125 Rudyard Street Richlands, QLD, 4077 (07) 372-4822  
ADELAIDE & N.T.: John Burrow  
4 Bandon Terrace Kingston Park, S.A. 5049 (08) 296-6926  
PERTH: Roy Alexander  
195 Guildford Road Maylands, W.A., 6051 (092) 28-7704  
RIVERINA: Bevan Brown  
7 Bursaria Street O'Connor, A.C.T. 2601 (062) 47-7605  
Also at Griffith (089) 62-1314

# TRADE TOPICS

Following the announcement in the October issue of CTSN of a new range of shotshells being produced by Eley at new LOWER prices, there have been many predictable reactions.

Winchester Australia reacted by offering its standard trap loads at equivalent prices. Meanwhile, apparently by co-incidence, Winchester dropped its complete sales range by 15% across the board, for October and November. As November 30th is the end of that Company's financial year, it would appear that this move is designed to enable the company to meet sales budgets. Over the past few months all firearms distributors have found sales difficult, and figures have been appreciably lower than during the boom of '75 and '76.

Meanwhile, others in the industry are continuing to establish themselves in clay target shooting fields. IT APPEARS THAT THE LONG ACCEPTED CLAIM MADE BY CERTAIN SECTIONS OF THE FIREARMS AND AMMUNITION INDUSTRY THAT CLAY TARGET SHOOTING IS OF LITTLE SIGNIFICANCE IN THE OVERALL PICTURE IS NO LONGER TRUE.

The FACT is that no other element of the shooting sports can match the present boom being experienced in clay target shooting. The suppliers to our sport who have brought about price reductions are to be commended for the part they have played in bringing clay target shooting within the reach of all who are interested.

Almost without exception, while wages have doubled since 1972, shooting costs are lower. If that doesn't stifle the growlers who claim that the sport is too expensive, nothing will. CLAY TARGET SHOOTING IS ONLY TOO EXPENSIVE TO THOSE WHO DON'T DISCIPLINE THEMSELVES TO KEEP WITHIN THEIR BUDGET.

## Federal Products Gaining Favour with Australian Shooters.

Since Fuller Firearms has taken on the distribution of the complete range of Federal products, it is interesting to note a growing preference amongst benchrest (rifle) shooters for Federal primers. In a recent report on the S.S.A.A. National Benchrest Championships (see Australian Shooters' Journal August '78) a list of products used by the ten top scorers in the Sporter Class, ALL were listed as using Federal primers.

This seems to echo a recent report in the American magazine "Guns" (August 1978) which states that again in benchresting "Federal dominates, with 81% of the primers used, followed by Remington and Omark. The Federal Match primers have established an incredible reputation for consistency . . ."

Fuller Agencies is handling Federal and Vihtavuori Primers, which gives that company a very commanding position in the market.

## Rabbidge still busy on Legislation Matters.

All shooters should be grateful for the effort put in by Geoff Rabbidge of Commercial Marketing Company Sydney in fighting any move which could result in repressive Firearms Legislation. Few people in Australia can match Rabbidge's intimate knowledge of the legislative situation Australia wide — two names that come to mind, of people in a similar category are Robert Mytton of the S.S.A.A. and Ted Clarke of the Victorian Firearms Owners' Committee.

In spite of his legislation campaigning, Geoff Rabbidge finds time to direct the activities of Commercial Marketing, the product range of which includes the full Smith & Wesson range of security systems and firearms products and a number of other crowd control products. In our fields, his main interests are Brno shotguns and rifles, and Sellier and Bellot cartridges. No doubt readers will have noticed that Commercial Marketing Co. is now a regular advertiser in C.T.S.N. and is selling very worthwhile quantities of cartridges, especially the S & B Special Skeet.

Geoff is very capably supported in his business by sons Mike and Peter, both young men who have already developed a great experience in the firearms industry. The enthusiasm of the two boys is the main reason that Geoff is able to devote so much of his time to crusading.

He has just concluded a campaign on behalf of the S.S.A.A., of educating NSW voters in the policies on the subject of firearms control, of the various parties which contested the NSW election. It is perhaps of interest to all readers nationally to read the comments of the leaders of the two major parties:

### 1. The Government (Prior to the election).

Mr Wran, to his credit, has extended the courtesy of his office to the Association and has given us his time in detailed discussions.

He has now confirmed that there is little point in stricter (gun) licensing laws and we quote in part from his letter to the Association. " . . . following cabinet this week I announced that having examined provisions in other countries, I now agree that there is little point in stricter licensing laws. The real attack must be upon the people who use violence and who use arms to commit acts of violence. The Government has decided therefore, that greater concentration should be given to increasing the penalties for such crimes." — Neville Wran, July 7th, 1978.

This policy is backed to the hilt by the Association and would, in our view, be supported by all responsible firearms owners. THE PREMIER AND HIS GOVERNMENT ARE TO BE CONGRATULATED FOR THE STRENGTH AND FORESIGHT OF THIS APPROACH.

### 2. The Opposition. (Prior to the election).

Mr Coleman, in a similar manner, has given the Association his time in detailed discussions. Some earlier press releases gave us concern as to what the Opposition's policy would be, but Mr Coleman has now assured us that he support the present legislation and its mode of operation: " . . . I am writing now to state that I stand by my earlier letter to you, as Chief Secretary, and it is the policy of the Parliamentary Liberal Party to support the present firearms legislation as introduced by the former Liberal Government and its mode of operation." — Peter Coleman, September 8th 1978.

It is interesting to note that a high level of co-operation (unusual for the firearms industry) has been demonstrated by commercially connected people in N.S.W. in relation to assisting in this educational activity. Well to the fore was Keith Herron, proprietor of Keith Herron Pty Ltd who is a tower of strength in the industry, but keeps his help very low key. Keith is another of our regular advertisers.

(Mr Coleman lost his seat at the subsequent election).

Evans & Balfour continues to do good business and in the financial year ending 30th June, produced better profit figures than for the previous year. Les Turner, Managing Director, reported this during a recent interview. His right hand man, Bob ("Phil") Richards has just returned to work after ten weeks long service leave, which he used to undertake an extended tour of the Continent.

There is a new product on the market, aimed at preventing damage occurring after accidental discharge of firearms. Although the ultimate is to prevent accidental discharge of firearms by community training programs, there is a place for this new equipment.

Called Gunsafe, it fits easily onto the barrel of any firearm and traps the projectile should an accidental discharge occur. The device consists of a rubber lined steel cap and is claimed to stop any bullet, projectile or shot that is fired into it.

The suggested retail price is reported to be below \$40, and further information is available from Gunsafe Systems, 172 Bettington Road, Carlingford, NSW, 2118.

With the 1978 World Championships now over, the Beretta people are elated with the results achieved by users of "S.O.4" shotguns.

The victory list is quite impressive as a quick glance will show: Trench — Gold Medal, Individual; Silver Medal, Individual; Ladies Silver Medal, Individual; Ladies Gold Medal, Team (2 members of team used S.O.4's). Skeet — Gold Medal, Individual; Gold Medal, Team (2 members of team used S.O.4's).

Brian Mark of Winchester Aust. in his capacity as Product Manager for Beretta and Browning products was obviously happy when he passed this news on. It seems rather ironic that news of this nature is available from commercial sources before details of Australia's performances have been received from official sources!

## TRADE PRACTICES ACT

The attention of advertisers is drawn to the Trade Practices Act 1974 and the provisions in the Act which apply to advertising. It is not possible for the A.C.T.A. to ensure that advertisements which are published in this magazine comply in all respects with the Act and the responsibility must therefore be on the person, company or advertising agency submitting the advertisement for publication. The A.C.T.A. and Waterwheel Press reserve the right to refuse any advertisement without stating the reason.

# Secretary's Notes

The reader interest in Clay Target Shooting News is developing at a rapid pace. The first week or so after the distribution of each issue sees the phones in the National Office running hot. Members ring for a variety of reasons, but without exception, each is welcome because the call is a demonstration of the growing involvement of our members.

The most interesting development during the past month has been the moves and counter moves occurring in the ammunition industry. *Clay target shooters have never had it so good, and NOW is the time to introduce your friends to the sport.*

Speaking of friends, I have surely lost one in the anonymous contributor "A Shooter" who has contacted the National Office again to echo the comments made by John Farrow in the October issue. *I owe "A Shooter" an apology for closing the gate on him (or her) before a reply was possible and now invite him to write to the National President, giving full details of the problems that are concerning him.* In this way, "A Shooter" you may be certain that your claims will receive the correct attention.

The second National Executive Committee meeting was conducted recently, and a substantial portion of this issue is taken up by a report of the meeting. Although some of the material may seem dry and un-interesting, it is published in the interest of COMPLETE AND RESPONSIBLE COMMUNICATIONS. Far too often in the past, the Executive Committee has been criticised for failing to report to members. Well, changes have occurred and you now have the opportunity to be fully informed IF YOU WANT TO BE!

## 1979 Registration Fees Due.

Membership fees (or registration fees as they should be called) will shortly fall due on January 1st, 1979. As the Christmas period is always a hectic time in this "Shootin' business," you can make your Club Secretary's job much easier by paying your fees as soon as possible.

The fees are:

Adult Standard Fee ..... \$20.00  
Second family Member fee ..... \$10.00

Junior (under 17 years at date of registration) ..... \$1.00  
Annual Subscription to C.T.S.N. .... \$10.00

Please remember that when renewing your registration you are REQUIRED TO SUBMIT YOUR 1978 CARD to enable the Club Secretary to correctly establish your grade and handicap. This is vital if common mark shooting is to succeed. ○

Good Shooting,

NOEL J. SOUTHEY.

## ELEY School Championship Bendigo Clay Target Club

On Wednesday the 20th September, Bendigo Clay Target Club hosted the 2nd Central Regional Championship.

The day was a great success with 200 shooters competing from the following schools: Kyabram High, Shepparton South Tech., Golden Square, Kangaroo Flat Tech., Cohuna High, Swan Hill Tech., Charlton High, Wedderburn High, Birchip High, Eaglehawk High, Rochester High, Castlemaine Tech., Flora Hill High, Echuca Tech., Echuca High, Wycheproof High.

The results are as follows: **Winning Teams** — OLD Echuca Tech 40-50, NEW Cohuna High 29.50. **Individual** — NEW R. Dunstan, Eaglehawk High 9-10. OLD S. Atkins, Echuca Tech 20-21. O/A High Gun S. Atkins, Echuca Tech 20-21. Girls Bambi Rymer Birchip High 5-10. **Regional Team** — M. Douglas, Cohuna High. H. Jones, Echuca High. R. Dunstan Eaglehawk High. T. McQualter Eaglehawk High. S. Atkins, Echuca Tech.

ELEY Ammunition apart from donating all products used on the day have also made available a shield on which the winning region will have their name engraved. The members comprising the regional teams will each be presented with an ELEY Jacket Badge.

PETER PEACOCK. ○

# WAR WAR WAR ON AMMO. PRICES !!!

Remington RxP 7 1/2 Trap ..... \$70  
Case 500 Blue Star Super Trap 7 ..... \$75  
Case 500 Blue Star Nickel ..... \$80 case

## WINCHESTER

AA or Ranger 7 8 9 ..... \$72  
Blk Ranger 7 8 ..... \$74 case

## FIELD LOADS

### all shot sizes

Ranger ..... \$75  
Blk Ranger ..... \$77  
Duck Load ..... \$88  
Super X ..... \$90 case 500

## All Ammo FREE to Rail

Don't ask, We don't know how long these crazy prices will last !!!

## PRIMED CASES

First Time Ever — New Winchester Primed Cases  
2 3/4 \$24 case 350

## WADS

New — N.Z. 1 1/2oz Wad ..... \$7 per 1000  
IMI Mono or Winchester AA or Wide Pattern  
\$9 per 1000 \$40 per 5000

## PRIMERS

New Win. 243 Dia or 245 Mag.  
\$14 for 1000 or \$65 for 5000

## RELOADERS

MEC 600 \$85 650 \$160 NEW  
Sizomatic \$140 Grabber \$230  
New ADJ Charge Bar for MEC 600 or Texan FW  
Weights from 4 1/2 to 70 grains powder  
1/2oz to 1 3/4oz shot ..... \$21 POST FREE

## GUNS — Browning

Trap 6-1/2 & Full B1 "C Grade" \$2700 Special \$1700  
B2 "D Grade" 1/2 & F, \$3080 Special \$1900  
Beretta 56E Trap ..... \$420  
Beretta 58E Trap or SKEET ..... \$500  
Franchi Barrage with Lea.Case,  
Trap or Skeet \$1233..... Special \$850  
Contento MK2 Trap with 5 chokes, giving all  
choke combination \$965 ..... Special \$550  
Contento MK2 Trap 30 F & M  
chrome barrels \$665 ..... Special \$380  
Browning Belgium Field Auto's, Recoil or 2000  
Gas, 30 Full \$795 ..... Special \$490  
Beretta Auto Trap ..... \$340

# Frank O'REILLY

869-871 High Street, Thornbury 3021

Ph 480 3366 — 44 1279

# 1978 NATIONAL TRENCH CHAMPIONSHIPS

International Gun Club, Virginia, S.A.,  
9th and 10th September, 1978.

Story and photos by Pat Browne.

From the outset it was shaping up to be the biggest and best National Trench Championship on record. Since the '73 World Championships in Melbourne, Trench Shooting has been steadily gaining momentum as Australian shotgunners have been easing into the high pressure world of ISU competition.

Originally scheduled for early October the event was moved forward to coincide with the National ISU Skeet Championships also held in Adelaide at S.A. Gun Club. The event was also shortened from three to two days. This in itself was to cause some problems later in the match as we will discover. The rationale behind the move forward in dates was to give the Australian Trench and Skeet Teams some top competition before their departure to Korea for the World Shooting Championships, and to provide an overall ISU shooting Carnival on the same weekend in the same State. In all it was regarded as successful.

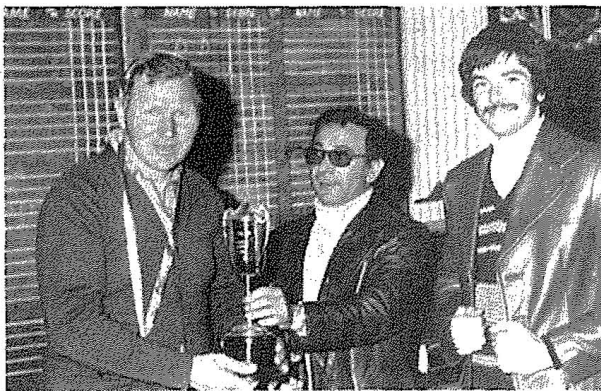

● It's Gold for Burgess as National Trench Champion for 1978. President of International Gun Club Paul Aromataris seems a little in awe as he presents the championship cup to Burgess.

International Gun Club was in its best spruced up condition and the Trench Complex sported a complete cover for the comfort of the shooters. This type of cover, whilst common in Europe is unknown in Australia but was well received by competitors.

The event duration of 200 targets and the target color was flouro red/black magpie. Again from the outset it was obvious that the competition would be tough with the roll up of the major part of the Australian team in Rumbel, Berry, Porter and reserve Lowry (Ellis had more pressing things on his plate in Canberra -to wit, his Wedding). Previous winner Burgess and a host of interstate hopefuls all converged on Virginia on Thursday and Friday prior to the championships for the official practice days.

Saturday dawned bright and clear and a maximum field of 60 faced the trench for the first 100 targets. Simple mathematics indicated that this large field would not make it through to Sunday night having to shoot the full 200 targets. Notice was posted very early that there would be a 'cut' at the 150 target mark.

But from the word go it was Pud Burgess that gave notice that he was running hot and it would be up to the rest of the field to stay with him. Pud really had the pressure on after the first 100 with 24-24-25-24 for a 97.

Showing the form that would carry him through to the Silver Medal, Blue Dot man Fred Rapley ran 25-22-24-23 in the first 100 for a 94 to be the closest to Burgess. Then came Ken Lowry 93 with Neil Berry and two local shooters in Dino Oliviero and Trevor Reschke on 92. At this stage Terry Rumbel could only put together a 89 and John Porter was two targets behind him on 87.

Into day 2 for the final 100 targets and again it was Pud Burgess that set the pace with a fine round of 25 first up and at the 125 target mark he had slipped five targets clear of Fred Rapley and six clear of Ken Lowry. Overall standings at 125 were:— Burgess 122, Rapley 117, Lowry 116, Long and Berry 115. Finis Budd and Reschke 114. In the grading the two overall leaders Burgess and

Rapley had AA and A well in their grasp whilst Roger Walker with 110-125 had a good grasp of B grade and there was some sort of a tussle developing between young Russel Mark and local boy Peter Marcioinni for the C grade crown.

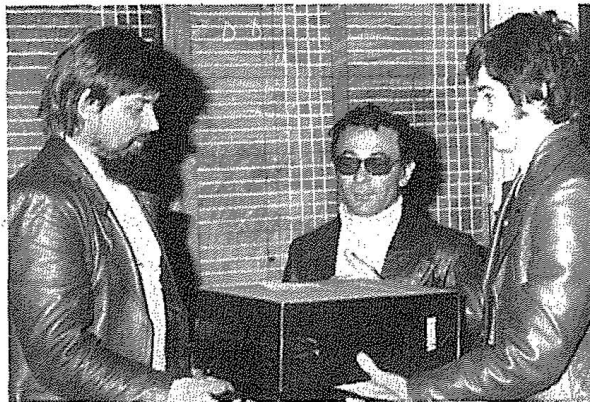

● Don't drop it Roger . . . both Paul Aromataris and Dino Oliviero present the B Grade trophy to Roger Walker. (It was incorrectly reported in October CTSN that Dick Ayres won 'B' Grade — sorry Roger!)



● C Grade winner Russel Mark receives his trophy from Dino Oliviero, International Gun Club secretary.

The decision was made to cut the field to four squads at the 150 target mark and so the pressure was right on to stay with it in round 6. Both Rapley and Burgess returned 23's to leave the lead unchanged but the experience of Rumbel, Berry, Porter and Lowry showed, when they all put together well controlled 24's to make the cut off point easily.

And so to the final 50 targets. It was some kind of drama with the final result in doubt until the final round. It was it seems, the time when all the top competitors came to grips with the targets. Burgess rolled off a perfect 25 in round 7 and Rapley stayed in touch with a good controlled 24. Shooting together in the same squad there was a deal of interest in the outcome.

Into round 8 (final) and the drama heightened. Burgess shooting lead off dropped his 6th and then his 9th target whilst Rapley shooting No. 3 kept his score intact. One could sense that perhaps something could happen and the atmosphere became electric when Burgess dropped the 19th target and Rapley was still holding it all together. But it was too much to expect the foxy Pud Burgess to miss three out of the last six targets, although he did drop his 24th for a 21. Rapley went clean to get within two targets but the final score was Burgess 191, Rapley 189.

Terry Rumbel gave everybody a lesson in Trench shooting to card a superb 50 straight in the last two rounds, an effort that pulled him up into third position in a count back from Ken Lowry.

Final Results — Overall: A. Burgess 191 (gold) F. Rapley 189 (silver) T. Rumbel 186 (bronze); AA Grade: A. Burgess 191 T. Rumbel 186; A Grade: F. Rapley 189 T. Budd 186; B Grade: R. Walker 175 R. Ayres 171; C Grade R. Mark 170 P. Marcioinni 167.

Cont'd on page 28.

# FISHER FIREARMS

104 GLEN OSMOND ROAD,  
PARKSIDE, S.A. 5063.  
Telephone (08) 272 8297

367A MAIN NORTH ROAD,  
ENFIELD, S.A. 5085.  
Telephone (08) 260 2324

*All Mail Orders & Wholesale Business to PARKSIDE address only.*

## SHOT GUNS BROWNING

A5 Auto (Belgium) .....	\$595
2000 Gas .....	\$595
A1 Trap and Skeet .....	\$1693
A2 Trap .....	\$1739
B1 Trap and Skeet .....	\$2095
B2 Trap .....	\$2395
B2G Trap .....	\$2395

### NEW SHIPMENT OF SPECIAL SPORTING GUNS HAS JUST ARRIVED

A1 .....	\$1695
B1 .....	\$2095
B2 .....	\$2395

## WINCHESTER

101 Pigeon Grade Trap .....	\$575
101 Pigeon Skeet .....	\$525
101 Pigeon Field ¼ and ½ .....	\$525
96 U/Over Trap & Skeet .....	\$395
Model 12 Trap Pump .....	\$495
Super X 12g Auto with 2 barrels .....	\$335

## BERETTA

504 with case .....	\$2950
58 Trap .....	\$620
55 Trap .....	\$445
57 Field .....	\$599
55 Field .....	\$439
54 Field .....	\$329
301 Auto .....	\$349

## 12G CARTRIDGES

Winchester AA Red Ranger Wide Pattern Low Recoil Xpert 2¾	<b>\$79</b> per case
---	-------------------------

## WINCHESTER WADS

Wide Pattern AA	<b>\$10/1000</b> <b>\$45/5000</b> <b>\$84/10,000</b>
--------------------	--

## WINCHESTER PRIMERS

AA Magnum	<b>\$16/1000</b> <b>\$70/5000</b>
-----------	--------------------------------------

## WINCHESTER SHOT

ALL SIZES BB - 10	<b>\$1080</b>
1000 kilo	<b>\$2060</b>
2000 kilo	<b>\$3000</b>
3000 kilo	<b>\$3000</b>

## POWDER SPECIAL

Winchester Shotgun 473AA	<b>\$69/10 lb</b>
-----------------------------	-------------------

## 12G HULLS

New AA primed hulls	<b>\$26/350</b>
---------------------	-----------------

# WINCHESTER

**PLEASE ADD FREIGHT AND \$2.00 PER PARCEL FOR PACKAGING AND HANDLING.**

*All goods are in stock at time of going to print. Due to short supply of some items, they may not be available at the time of your purchase.*

**WE HAVE GUN SMITH SERVICES AND SCOPE REPAIRS AVAILABLE.**

## 1978 National Trench Championships (Cont'd)

Competitors and visitors were wonderfully well catered for in the traditional International Gun Club manner and it was regarded as a very well conducted shoot. Administrative help and advice was forthcoming from ISU Chairman Harry Somers and National Secretary Noel Southey and daughter Kerry who also rode herd on the National Coaching Director Newton Thomas.

Perhaps we can end this report with a quiet but profound statement from JNT . . . "There is no doubt about that Burgess . . . he's a good shot!" Newton is not prone to understatement but perhaps we have caught him out just this once.

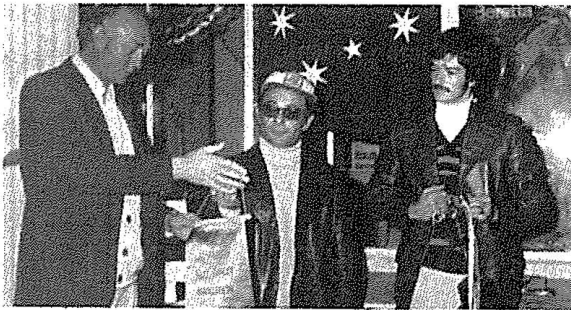

. . . And thank you for a job well done . . . as ISU chairman Harry Somers presents an ACTA bannerette to Paul Aromataris and Dino Oliviero from the committee of the International Gun Club, host club for the Trench Nationals. (Photos by courtesy of Pat Browne).

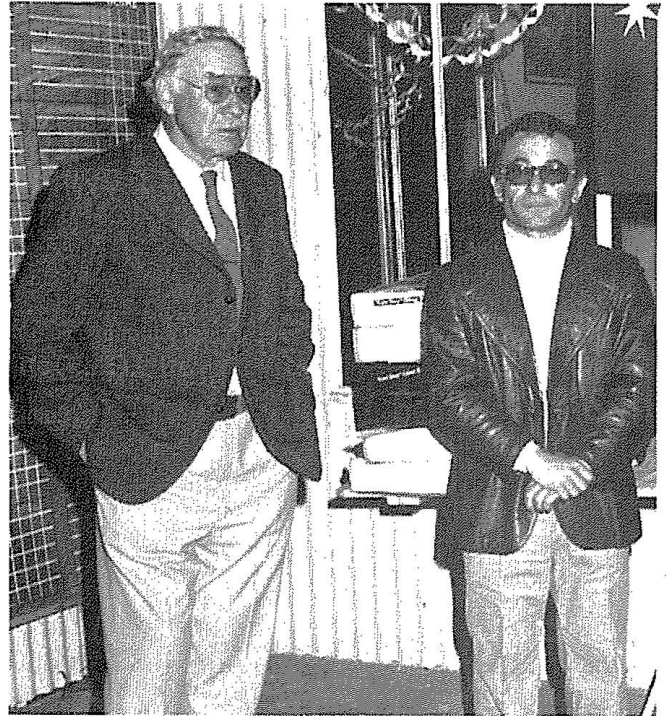

. . . 'There's no doubt about that Burgess . . . he's a good shot' . . . Aromataris thinks it's a bit of an understatement.

## SCOREBOARD

### 1978 National Trench Championship

International Gun Club, South Australia - 9th & 10th September, 1978

NAME	1st	2nd	3rd	4th	First 100 Age	5th	6th	7th	8th	Total
REG BOYCE	20	19	22	22	83	20	21			
L. NUZZOLESE	22	21	23	20	86	20	20			
T. PROSKE	19	21	22	23	85	21	22	21	19	168
F. RAPLEY	25	22	24	23	94	23	23	24	25	189
K. LOWRY	22	23	24	24	93	23	24	23	23	186
I. CAMPBELL	21	21	22	20	84	23	20			
L. CONNORS	17	17	20	18	72	21	22			
A. M. BURGESS	24	24	25	24	97	25	23	25	21	191
R. MORRIS	23	20	19	22	84	22	24	21	21	172
M. BAKER	21	18	19	20	78		19			
B. BROOKES	12	18	18	12	60	17	20			
STEVENS S.	21	23	23	23	90	20	24	24	21	178
LUCAS T.	19	20	19	18	76	19	20			
BURGESS V.	19	21	21	20	81	20	16			
LONG G.	23	23	24	21	91	24	22	22	23	182
FINNESS J.	23	22	22	23	90	24	23			183
MOLLIKA V.	22	22	21	20	85	22	21	24	13	169
OLIVIERO D.	24	25	21	22	92	21	20	21	22	176
DIZANE N.	12	16	17	14	59	14	17			
NAPOLI J.	17	21	23	22	83	24	21	21	21	170
WALKER R.	22	23	22	20	87	23	20	25	22	175
ZUFFO S.	20	17	20	17	74	20	18			
BUDD T.	22	23	23	23	19	23	24	25	23	186
SKY R.	19	22	19	19	79	23	22			
KAVANAGH A.	17	23	21	17	78	19	21			
ZANIOL K.	20	19	20	20	79	22	22	19	20	162
BYRNES J.	18	21	22	21	82	21	20			
BOLLEN GARY	19	19	20	20	78	17	20			
RUMBEL T.	22	21	24	22	89	23	24	25	25	186
PORTER J.	24	19	22	22	87	22	24	24	20	177

BOLLEN G.	16	20	19	16	71	20	19			
BISI R.	19	20	19	14	72	15	21			
MORTON P.	21	19	23	17	80	25	22			
WHITELAW M.	17	22	19	21	79	21	24			
DEVRIES R.	19	20	21	18	78	18	23			
BERRY N.	23	24	21	24	92	23	24	23	22	184
SHANDLEY B.	20	22	15	19	76	16	19			
AROMATARIS P.	18	16	20	17	71	18	18			
MARK B.	20	19	22	23	84	23	22	22	23	174
MARK G.	17	23	19	21	80	24	24	22	23	173
MARK R.	20	23	21	21	85	19	22	23	21	170
KNEEBONE C.	22	23	19	20	84	20	23			
McINTYRE A.	19	19	17							
CLARK J.	17	21	12	18	68	18	19			
MOIA L.	14	15	15	13	57	17	20			
AYRES R.	24	21	21	21	87	20	21	23	20	171
MARTIN L.	23	21	22	19	85	20	23	23	18	165
WHITEHEAD M.	20	18	20	22	80	23	20			
DYSON K.	20	15	16	21	72	21	22			
TOSOLINI A.	18	23	23	19	83	18	17			
RESCHKE T.	23	23	23	23	92	22	19	21	22	176
STRAMERE E.	15	20	18	18	71	19	17			
MARTINI M.	16	21	23	18	78	18	22			
MUSCIO G.	20	19	19	21	79	22	18			
PIPICELLA A.	20	16	14	15	65	21	20			
FLOWER V.	19	21	19	18	77	22	19			
ROWE T.	22	19	23	20	84	22	20			
BOULD A.	23	21	22	19	85	23	19			
ARNOTT B.	23	20	17	16	76	18	18			
MARCIONI P.	21	20	20	22	83	23	22	19	20	167

PLACINGS — A. M. BURGESS 191-200, F. RAPLEY 189-200, T. BUDD, T. RUMBEL, K. LOWRY all 186-200.

# 1st National Olympic Skeet Championship

SAGC — 9th-10th September, 1978

Saturday 9th

Weather Conditions: Good, warm light breeze.

Attendance: 12

Got off to a slow start, around 10 a.m. We held back the start slightly hoping a few more might turn up. Unfortunately by 10 a.m. we still only had 12, so after making the draw, formed 2 squads of 6 and commenced shooting. John Summers took an early lead by posting a 25 straight and at the half way stage on day one was still leading with a 50 straight.

We had plenty of time on hand so we had a one hour lunch break.

John Summers still running on Victorian time was almost late for his third round but didn't let that worry him and for the third time in a row posted a 25 straight.

In the fourth round all was well until John's double on station 5 when having shot 90 straight he clean missed both in the double. But a perfect example of self control and concentration saw John smash his last eight targets as brilliantly as he had smashed his first 90.

So at the end of day one John was in the lead with the fantastic 98/100.

And as expected the other Australian team members filled second, third and fourth spots. But not too far behind them in the 'B' grade section we saw Mr Bob Buchan, President of the Melbourne Gun Club and Victorian State Association, and a real hard working supporter of ISU shooting in Australia, putting pressure on a new face in ISU Skeet from NSW, Graham Boyd. Graham has shot very little ISU Skeet, in fact I believe this was his first major competition but he made a good effort and kept on trying.

Sunday 10th

Weather Conditions: Very good, warmer.

After a re-draw for day 2, shooting got under way around 10.15 a.m. Once again we saw Mr Consistency, John Summers, take the lead with yet another 25 straight. Alex, Ian and Fred were again up there but so too was Graham Boyd with a 23. At the 50 stage John was still leading with a 50 straight and Graham Boyd who shot his first ever 25 ISU straight was close behind with 48.

Only half hour for lunch today. Into the third round John missed the first target and shot a 24 but was still well clear of his nearest rival, Ian Hale.

As John went out for his last 25 we were all keeping our fingers crossed, in fact if I'd crossed anything else I'd have fallen over.

Well, John was clean as he stepped on the block to shoot station 8 now and as a cloud of smoke disappeared in front of him John finished the day with an incredible 99/100, giving him the Grand Total of 197/200. A truly world class score. Ian finished second with 186/200, Alex third with 184/200 and Fred fourth with 178/200.

Graham Boyd took the lead in the 'B' Grade on the second day and finished with 175/200 just in front of Bob Buchan who finished with 172/200.

Bob Buchan recognised the keenness of our local shooters and like the true gentleman and sportsman he is donated his trophy to the top South Australian 'B' Grader, John Torresan. Dave Gagnon also from South Australia received the Eley ammunition encouragement award.

I personally would like to take this opportunity to thank the members of the South Australian Field and Game Association who have supported us in ISU Skeet in the past and hope they will continue to support us in the future.

Summary

I'm sure that ISU Skeet is here in Australia to stay but to make it move as fast as it should there has to be more encouragement to the beginner. At future ISU Skeet Nationals I would like to see a grading system introduced, run on the same lines as trench grading, eg. AA, A, B, C, worked on the shooters percentage per 100 targets.

Also at normal Club level we at the SAGC have for sometime been using an ISU Skeet Handicap formula which has encouraged a lot of our local shooters to try their hand at ISU.

But I'm quite sure that until there is a Nationally ACTA recognised grading system introduced to give everyone a fair chance then ISU Skeet may not get the support it so urgently needs. ○

John Turner, SAGC.

# ISU Skeet Championship — S.A. Gun Club

SCOREBOARD 1978

	11	17	10	13	51	19	16	15	14	Total Score
D. Gagnon	11	17	10	13	51	19	16	15	14	115
P. Avison	20	19	19	24	82	21	20	19	19	161
J. Torresan	20	23	15	18	76	20	18	18	20	152
A. Crikis	24	22	22	23	91	24	24	23	22	184
G. Goldsmith	17	13	19	16	65	17	20	18	15	135
R. Buchan	22	21	21	22	86	22	23	20	21	172
J. Summers	25	25	25	23	98	25	25	24	25	197
F. Guyatt	22	21	24	22	89	23	22	23	21	178
I. Hale	23	24	24	24	95	23	24	21	23	186
G. Guy	22	16	19	20	77	22	20	19	21	159
G. Boyd	24	22	19	18	83	23	25	21	23	175
D. Vogt	15	17	16	16	64	17	15	16	20	132

## RESULTS

Overall 1st John Summers 197-200, 2nd Ian Hale 186-200, 3rd Alex Crikis 184-200.

'B' Grade 1st G. Boyd 175-200, 2nd R. Buchan 172-200.

## VALE — Don Taylor of Upper Hunter Gun Club, N.S.W.

Don Taylor has been a keen supporter of Upper Hunter Gun Club since he joined in 1964. After suffering a heart attack in May this year, he demonstrated his enthusiasm by being back at his Club as an onlooker at the July match. Unable to control his keenness, he shot in the last event which was a Deauville Doubles event — his partner was Geoff Clendenning, who had also been out of shooting due to injuries. Don was aged 73 years.



**BROWNING**  
TRAP & SKEET GUNS  
EX STOCK

Browning A1 (A grade)  
No.2 Special Trap.  
Browning A2 (B grade)  
No. 2 Special Trap.  
Browning A1 (A grade)  
Special Skeet.

High grade models available ex factory — delivery from 3 weeks,  
depending on stock on hand at factory — Contact us for delivery  
details and prices.

OUR PRICES ARE  
MOST COMPETITIVE

Write for Free Browning Catalogue.

Trade enquiries welcomed.

**LOY ARMS CORPORATION**  
**PTY. LTD.**

87-89 Foveaux St., Surry Hills,  
New South Wales 2010  
Telephone (02) 212 5777

# VICTORIAN STATE CARNIVAL



• Victorian Ladies State Team (1978 Bendigo) left to right: Deserie Wakefield (Mildura), Karen Taylor (Melbourne), Karen Williams (Geelong), Sue Lowry (Mildura), Joan Mills (Morwell).

## 26th, 27th, 28th August, 1978

Two hundred and twenty-three shooters turned up at the Bendigo Gun Club to contest the major State titles and endeavour to make the coveted State Team.

Bendigo Gun Club situated in the North East Zone were acting as hosts on the State Associations behalf, and conducted the tournament. Extensions had been made to the club rooms to allow for the influx of visitors expected and a fourth trap had been installed to cater for the shooting to take place over the three days.

The usual top line shooters in the State and familiar faces that adorn the shooting tracks whenever the major titles are at stake were there to do battle, even some top liners from N.S.W. trying to collect a sash or trophy.

The first major event conducted on Saturday, the Victorian Double Barrel Championship enticed two hundred and twenty-three entries. Only three shooters, Vin Ryan, Cosgrove, Brian Rafferty, Maryborough, and Bill Iles, Metropolitan, managed to card the possible. The shoot off was probably one of the shortest ever for a Double Barrel event, and was all over with only two targets being shot at. Vin Ryan was first 'A' grade and overall with 32-32, Bill Iles, 2nd, 31-32 and Brian Rafferty, 3rd, 30-31. 'B' grade went to 1st Jim Blythman 29-32, 2nd J. Harker, 28-32 and 3rd J. Landry, 36-41. 'C' grade 1st, T. Hobson, 27-30, 2nd M. Potter, 28-32, and 3rd B. Harmer, 27-32. 11 to 13m was I. McKay, 27-33. Best Junior, Russell Mark 32-36. Russell is the 14 year old son of top shot Brian Mark, of Winchester fame and looks like following his father's prowess. The Victorian Ladies Double Barrel Championship was won by D. Wakefield, 26-30, 2nd I. McKay, 26-32, 3rd H. Strautins, 25-32. The second event, the Carnival Grand Handicap was won by G. Ewart, 20-21, 2nd D. Hill, 19-21 and 3rd M. Potter 16-17. B. Knight captured 19 to 21m group with a score of 18-19 and B. Rafferty the 22-25m group with a score of 15-16. This event ended the first day of activity and weather conditions were not good for shooting, it was cold, overcast and windy. Targets seemed to be exceptionally elusive

with very few shooters being able to put together good scores, some shooters seemed bewildered by the difficult targets.

After a night's rest shooters were back on the ground, squadded and ready to contest the Victorian Points Score Championship at 10 a.m., the required starting time. Entries had dropped a little from the previous day and the event finished with 183 competitors. Brian Rafferty from Maryborough who had been shooting well the day before took out the honours, being 'A' grade and overall, his score 89-90, David Patterson, Sebastopol, was 2nd 89-93 and Neil Berry, Shepparton, 3rd, 86-93. 'B' grade, G. R. West was 1st with 93-99, 2nd G. Norris 90-90 and 3rd H. Frankling 84-99. 'C' grade went to J. Close 1st 81-90, 2nd Mrs Sue Lowry 80-90 and 3rd S. Atkins 94-108. 11-13m group S. Atkins 79-90, Best Junior R. Bull 80-90. In the Ladies Victorian Point Score Championship, Mrs Sue Lowry took top honours with a score of 80-90, Karen Williams was 2nd 77-90 and Deserie Wakefield 3rd 76-90.

From the events so far completed the State Team was selected and the following shooters were honoured with a State Team badge. Brian Rafferty, Maryborough, Neil Berry, Shepparton, Geof Mark, Sebastopol, Ian Dickens, Geelong, John Wojeik, Brian Lowry, Melbourne, David Patterson, Sebastopol, Vin Ryan, Cosgrove, William Drew, Mildura, Trevor Byrne, Shepparton, Alf James, Maryborough, Max Gribben, Cosgrove, Jim Gawith, Jeparit, Ken Lowry, Melbourne and Bruce Hall, Bairnsdale.

After the actual teams match was shot Neil Berry collected Team High Gun trophy. His score 146-150. The State Ladies consisted of Deserie Wakefield, Mildura, Karen Williams, Geelong, Sue Lowry, Mildura, Karen Taylor, Melbourne and J. Mills. Deserie Wakefield collected Team High Gun with a score of 73-75.

It was still cold and windy with the Carnival Double Rise Championship in progress after completion of the teams match. Colin Knight from Bendigo was 1st 'A' grade and overall with 19-20. 2nd Ted Pitt from Jeparit 29-32 and 3rd Ray McKenzie, Echuca 28-32. 'B' grade 1st J. Blythman 22-26, 2nd A. Morgan 21-26, 3rd R.





• Victorian State Team (1978 Bendigo) left to right, back row: Bruce Hall (Bairnsdale), Trevor Byrne (Shepparton), John Wojeik (Wangaratta), Brian Lowry (Melbourne), Vin Ryan (Cosgrove), Bill Drew (Mildura), Alf James (Maryborough), Ken Lowry (Melbourne). Seated: Neil Berry (Shepparton), Ian Dickens (Geelong), Brian Rafferty (Maryborough), Geoff Mark (Sebastopol), David Patterson (Sebastopol), Jim Gawith (Jeparit), M. Gribben (Cosgrove).

Angove 18-22. 'C' grade 1st M. Pitt 16-20, 2nd B. Harmer 16-22, and 3rd T. Hobson 17-22. 11-13m group A. Morgan 21-26. Best Junior, D. Wakefield 21-24. Best Lady D. Wakefield 17-20.

On Sunday evening the General Meeting of the State Association was conducted in the club rooms. It was a good meeting and gratifying to see the interest being taken by shooters in general in the welfare of their sport. Robert F. Buchan, Melbourne, was re-elected State President for ensuing twelve months with Kevin Dobson, Echuca, filling the Vice-President's position.

At 9 a.m. Monday the Victorian Single Barrel Championship commenced. Only one hundred and fifty-three shooters entered this event, but it was a good muster considering it was Monday and not a public holiday, and a number of shooters would have had to return to their various responsibilities of employment, etc.

It was a graded event and 'A' grade was won by J. Green 30-32, 2nd N. Patterson 40-42, 3rd W. Dalzell 39-42. 'B' grade 1st A. McSween 33-39, 2nd J. Blythman 32-37, 3rd J. Landry 48-54, 'C' grade B. Harmer was 1st and overall with a score of 31-32, 2nd J. Shellcot 29-31 and 3rd T. Hobson 28-31. 11-13m group I. McKay 25-30, Best Junior N. Daymond 24-30. Ladies Victorian Single Barrel Championship, 1st I. McKay 25-30, 2nd M. Hammond 23-30, 3rd B. Dupey 22-30. Eley Points Score Championship 'A' grade J. Green 105-105, 2nd M. Gribben 102-105, 3rd W. Coulson 87-90. 'B' grade P. Smith 59-60, 2nd B. Pyke 61-63, 3rd D. Missen 60-63, 'C' grade 1st B. Stokes 65-66, 2nd J. Shellcot 64-66, 3rd H. Golding 58-60. 11-13m group T. Hobson 60-66. Best Lady D. Wakefield 54-60. Best Junior D. Wakefield 54-60. In the individual Eley Teams Match Handicap shootoff P. Edmondson was 1st, shooting 54-54 in the shootoff, 2nd was J. Sheppard 53-54 and 3rd M. Potter 49-50. B Jennings won the Points Score.



L. to R. 3rd placegetter Brian Rafferty and Bill Iles runner-up congratulating Vin Ryan on winning the D.B. at State Carnival, Bendigo. (Photo by courtesy of Joe Collins).

Bendigo Gun Club won the State Team Premiership after a shoot off with Morwell Gun Club. Bendigo team managed to shoot a possible to collect the major trophy. Deserie Wakefield Mildura won the Ladies High Gun on event 2, 4 and 8 with a score of 123-150. Brian Rafferty proved he was a champion by winning both High Gun trophies in event 2, 4 and 8, shooting 146-150 and in events 2, 3, 4, 7, 8 and 9 shooting 233-245. For this Brian collected an airfare to the 1979 New Zealand Nationals, the ticket being courtesy Air New Zealand.

For shooting the Carnival was a great success and the gratitude of all in attendance is extended to the North East Zone and the Bendigo Gun Club for their effort. ○

Report by LAURIE CONNORS,

Victorian State Association.

An Introduction to  
**THE DEER OF AUSTRALIA**  
by Arthur Bentley

This is the source book on all aspects of Deer in Australia. Hard cover Library Edition of 352 pages, 110 illustrations including 14 color plate. \$17.50 inc. pack & post.

Pick up from or post your cheque to  
A.C.T.A., 37 Swanston St., Melbourne 3000

**KRIEGHOFF**  
**Model 32**  
**Trap and Skeet Guns**

Choice of barrel lengths, chokes, gauges, stocks and grades.

**J. S. MIATT**

P.O. Box 48, Sans Souci, N.S.W. 2219  
Phone (02) 546 2354

# State Associations Report

## Northern Territory

Although there is no official State Association YET in the Northern Territory, such a development is in an advanced stage of development.

The project received great impetus as a result of the visit to Katherine by the National President, Ern Hawkins back in July. Since then, Horrie Mills of Alice Springs Gun Club and Kevin Bowring of Darwin Gun Club have been to the fore in keeping the pot boiling, and present indications are that the inaugural meeting of the new Association will be held early in 1979.

Meanwhile, following the creation of the State of Northern Territory, one of the early legislative projects is to control firearms. Reports recently received made it quite apparent that firearms users will have a battle on their hands as early suggestions include such outdated ideas as registration fees for firearms (together with recorded information for each firearm) and many of the other restrictive clauses which have appeared in South Australia legislation. WHY IS IT THAT SPORTING SHOOTERS, WHO REPRESENT ONE OF THE SIX LARGEST OLYMPIC SPORTS, ARE ALWAYS AT THE HEAD OF THE QUEUE WHEN LEGISLATIVE CONTROLS ARE BEING CONSIDERED?

---

## Queensland Clay Target Association

Following representation to the Premier the Hon. J. Bjelke Petersen, M.L.A. who is also the Patron of Q.C.T.A. we have been advised by the Hon. Mr. T. Newberry M.L.A. that covering the question of Government subsidy for coaching of Juniors, Mr Newberry advised that the guidelines laid down by Cabinet to be followed in the allocation of subsidies for coaching of juniors provide that subsidies may be paid on the basis of one dollar for each one dollar raised and expended by the organization itself with the proviso that no subsidy will be paid on grants received from outside sources.

Most sporting bodies have a definition of junior and this definition is accepted, but where the sport does not define the junior age then a junior is classed as under eighteen.

Gun clubs, until recently, applied direct for subsidy from sporting funds as there was no State Association for the sport and the clubs were affiliated direct with the Australian Clay Target Association. This has recently changed with the formation of the Q.C.T.A. and for the 1979/80 financial year, applications from Gun Clubs will require to be submitted through the State body.

Up to and including the present financial year, no application has ever been received from a Gun Club for subsidy for coaching juniors, although many applications have been received and approved and payments made towards the cost of the development of facilities.

The Premiers Dept. has further advised that:—

Section 14(a) 1. of the Firearms Act 1927-67 states that any person under the age of seventeen years who discharges, carries, buys, sells or has in his possession any firearm or any kind of ammunition for a firearm shall be guilty of an offence against the Act.

Section 14(a)4. of the Act however gives authority for the issue of a permit, by a member of the police force for the time being in charge of a police district to a person under the age of 17 years, residing or employed in that district, to carry, have in possession and discharge a firearm and to have possession of ammunition, for the purposes specified in that permit.

In this regard, the member of the police force referred to may issue his permit for such a period and subject to such terms and conditions as he deems fit.

Having in mind the provisions of sections 14(a)4., applications may be made by juniors, under 17 years of age, who wish to participate in shoots on approved rifle or gun club grounds, to the Inspector of Police of the particular police district concerned, who may in his discretion issue the necessary permits allowing such juniors the privilege of shooting.

Certain amendments to the current Firearms Act are presently under review and there is every possibility that certain proposals will be made to alter the position relating to persons participating in shooting matches on the ranges of approved Pistol, Rifle and Gun Clubs.

We are also pleased to advise that 40 clubs have affiliated with Q.C.T.A. — also there are three newly formed clubs in Queensland, namely Texas, Greenvale, Mary Kathleen.

At the time of writing an extension has been granted to the Art Union drawing time, this will now take place on 26th November at Gladstone Gun Club, all shooters were advised of this, and urged to take more interest in club administrations. We feel this is necessary as correspondence is not getting past a percentage of club secretaries.

At the Q.C.T.A. meeting in Brisbane in August the President reported that successful meetings have been held in each of the zones. Zone carnivals have been arranged for 1978 showing the enthusiasm of the Queensland shooters, to make the Q.C.T.A. a success.

In an effort to encourage clubs to observe the rules, and to have complete uniformity and application of the A.C.T.A. shooting rules, we have written to all registered referee examiners urging them to attend a seminar to be held in Gladstone on 25th November.

Under the guidance of State Coaching Director Mr W. Stevens, Zone Coaches have been appointed. Some clubs have taken advantage of the Coaching plans and already a successful seminar has been conducted at Kingaroy and Brisbane.

A State Carnival is being organised for May next year, it will be conducted over three days, 5th, 6th, 7th May, at Brisbane Gun Club. The State Team will be chosen at this shoot, thus giving Queensland the chance of a strong team of shooters. Mr and Mrs R. Porter have kindly offered a Perpetual Trophy for the Queensland Champion of this Carnival.

Due to the resignation of Mr A. Kenna, Mr N. Hardy of Townsville has been appointed to the executive committee of Q.C.T.A. and is also Vice-President.

A State Badge is to be struck the design being the same as the Brisbane Nationals Badge with a bar hanging to depict the zones Commonwealth, State and Zone championships have been allocated for 1979, and clubs have been advised.

Copies of the Q.C.T.A. constitution are available, shooters requiring one of these please write to the secretary for these.

A program booklet for 1979 for ALL Queensland clubs is under way, this booklet shows locations of each club also major shooting events and annual shoots.

The next Q.C.T.A. State Councillors meeting will be held on 26th November at Gladstone Gun Club.

S. ANGEL, President.

---

## Vic State Assoc. News THE VICTORIAN COACHING SCENE

The thought occurred to me that the answers to a couple of good questions put to me over the last few weeks should be answered in our coach's column as follows:

Question one —

What are the objectives of the Australian National Coaching Council and how can they affect me as an average shooter?

Answer —

Our objectives are:

1. To develop greater interest and promote our sport of clay target shooting, so that people of all ages and walks of life may become more efficient, whether for competition or just leisurely good fun.
2. To assist on the higher level of international competition with the training and coaching of our overseas teams. Also the setting up and development of training camps for international competition.
3. To help our many gun clubs in the selection and training of club coaches so that they may avail their club members of the basic principles of shot gun shooting.
4. Making the new shooter feel welcome to our sport, to further develop the novice shooter's confidence in his ability to become a better shot.
5. To promote and practice a responsible attitude in the use of firearms at all levels and all ages, in all places. Safety first must be practised whenever we use a firearm.

Question two —

What do we mean when we refer to the basics of shot gun shooting?

Cont'd on page 88

# Report on A.C.T.A. Group Tour to U.S.A. & Grand American Championships

ERN HAWKINS, President.

The idea of building a group tour around Australia's Team attendance at Vandalia proved to be very successful.

Thirty-two members left Sydney on 3rd August to commence a busy schedule of sightseeing at Los Angeles, Hollywood, Disneyland, Las Vegas and the Grand Canyon which left most of us thinking that at least a month had gone by instead of seven days. The sights were unbelievable to the first time visitor and there is no substitute to learning of these places other than actually being there.

Then followed our visit to Milwaukee, which I thought to be the prettiest part of the tour, then Dayton and the unbelievable Grand American grounds. From there the majority of the group undertook a side trip to Niagara Falls and Washington where again the scenery and attractions had to be seen so as to absorb their real meanings.

From Dayton we progressed with reducing pressure to San Francisco and its sights for several days and then finally to Honolulu where the group appeared to enjoy themselves immensely, sightseeing, dining out, etc. I am sure they would have all stayed longer at this location.

My presence in the group was mostly as a holiday tourist and in no official capacity. However at our gun club visits, which are described below, there were official recognitions and presentations made and given.

On our return home I distributed a questionnaire to members of the group and some of the comments made in this report are based on the answers I have received. My comments on shooting are also influenced by discussions with A.T.A. officials, Gun Club officials and shooters from widespread areas of U.S.A.

## Visit to Bob Taylor's Gun Club Las Vegas

This was our first attempt at shooting on the tour and our introduction to the club was, to use that word again — unbelievable.

We were met at the airport by Mrs Taylor and club officials who guided our self drivers to our hotel where we were given a full police escort — car and three motor cycles — who took us through down town Las Vegas at 50 MPH with sirens screaming, lights flashing, etc., through red lights and stop signs and continued with us in a non stop run for the full twenty miles to the club.

This reception combined with a temperature of 114°F probably caused the poor scores put up by most of us in the only event available — a 100 target handicap in which we were all placed on 20 yards. However Rob Cartledge and Tim Catling managed to shoot well enough to win two of the main prizes.

A presentation of an A.C.T.A. Banner, inscribed piece of Queensland petrified wood and some Adelaide Nationals souvenir wine was made to the Taylors in appreciation of their welcome to us. Bob Taylor contributed some wise comments on the concept of shooting in the U.S.A.

## Visit to Waukesha Gun Club Milwaukee

Here again we were met at the airport by Vic Reinders and club officials and welcomed before travelling on to our motel. The next morning a club organised bus picked us up and on our arrival at the club each family or individual member of our group was met by a local family or individual with similar interests who acted as host for the day.

This pre-planning was indicative of the splendid treatment we received during the day. We shot a program of interesting mixed events — including International, U.S.A. style — on one of the most pleasant and picturesque Gun Clubs that I have ever seen. Our scores were quite good and prizes were well distributed throughout the group.

Again similar presentations on behalf of the A.C.T.A. were made to the Reinders for the tremendous effort they had put into making the day so enjoyable and friendly.

## Vandalia — The Grand American

This is what we had all come to see and again it has to be seen to be believed. Seventy-two traps extending over a distance of one and one quarter miles on the edge of an International Airport where the Nationals are of such importance that one runway is closed down and where some 4200 shooters competed in a 100 target event which was concluded in one day gives some idea of the immensity of the operation.

The shooting grounds, the conditions, the targets were all about as perfect as they could be but there were many things that to our minds were not good.

Safety in gun handling as we know it was practically non-existent; shoot offs were practically non-existent; and shooters were apparently able to select the targets they wanted to shoot at.

Because of the size of the operation there was no social atmosphere but everything ran like a big well oiled machine and there did not seem to be any hassles or drama of any kind.

Our group was made very welcome by the A.T.A. from the time that their President Forrest Woods, some of his Executive and his General Manager met our plane at Dayton, to the explanation of procedures and assistance through registration by Vice President Len Burford. We were well accepted by shooters on the grounds and by the business people with trade displays. Most members of the group remarked on the hospitality shown by the Remington-Peters organisation.

We were officially welcomed to the Championships and in a very limited ceremony a presentation of gifts similar to Bob Taylors and Vic Reinders was made to Forrest Woods. As President of the A.C.T.A. I was presented with a handsome engraved silver belt buckle by Forrest Woods on behalf of the A.T.A. and for this I was most appreciative.

At this ceremony I issued an official invitation to the A.T.A. to send a team to our Nationals at Griffith and suggested they build a group around the team as we had done.

The purpose of our visit to Vandalia was our teams entry in the International event and we can be very proud of the fact that our team took our the bronze medals for third place only six targets in 500 from the winners. Great scores were put in by Bob Smith and Rob Cartledge in this event.

In other events Rob Cartledge was probably the most successful with scores that included one 100 straight from 16 yards.

To briefly sum up Vandalia, based on our groups response to my questionnaire, on comments from Gun Club officials, shooters and A.T.A. officials in U.S.A. and from my own observations I list the following points:—

1. We should not relax our safety rules in any way.
2. We should look at only calling lost targets (2 or lost in Point Score).
3. We should look at shooting all the appropriate targets from each lane before moving (2 per lane in 10 target events and 5 per lane in 25 target events).
4. We worry too much about amplifiers and other noises while shooting.
5. We should upgrade our official opening ceremony at the Nationals.
6. We should have a Hall Of Fame.
7. We look at the practicalities of introducing a "Lewis Class" type of prize distribution.
8. We should continue the present method of selecting our U.S.A. Team with a condition that a shooter having once received a trip to the U.S.A. is ineligible for the next two years.
9. The "International" Event in U.S.A. should be Single Barrel from 16 yards instead of 20.
10. We should have more than one National shooting ground.

Since the U.S.A. trip I am personally more convinced that we need two National shooting grounds, located in areas of shooter population such as Melbourne and Brisbane, with one of them as our National Headquarters, Hall Of Fame location, etc.

I am afraid that if we had one location we would drop in attendance to the stage where our existing grounds in each State could cope.

However the overall trip was a great experience — it was certainly no holiday — and I am sure that many of us will need our photographs to remind us that it was not all a dream.

May I conclude by thanking Roy Holtfreter for accepting the responsibility of Acting President while Ron Porter and myself were away. ○

# CLAY TARGET



# NATIONALS '79

## “Nationals” Planning Proceeds Smoothly

At the recent Executive Committee meeting a number of decisions were made which will interest shooters planning to attend the 1979 National Clay Target Championships to be held in Griffith, New South Wales.

Probably the two items of greatest interest to competitors are those connected with costs. Well on both scores, the news is good — nominations have not increased from 1978 and some cartridge prices have dropped dramatically.

Nominations will be as follows:

National Skeet Championship .....	\$18
National Double Rise Championship .....	\$16
Grand Australian Handicap .....	\$18
National Double Barrel Championship .....	\$18
National Single Barrel Championship .....	\$18
Australia-New Zealand Trap Championship .....	\$18
Champion of Champions Cup .....	\$18

All the above entry fees include sweepstakes.

Cartridges prices will be as follows:

Eley range (including recently introduced products and Eley G.T.) — \$80 per case or \$4.30 per pkt.

Winchester range — \$113 per case or \$6.00 per pkt. *(It is almost certain that the Winchester price will be revised before the event!)*

Practice facilities will be available whenever possible, and shooting will be regulated by the issue of practice tickets. Each ticket will cost \$1.00 and will entitle the buyer to 10 targets.

Advertisements have been placed inviting applications for positions as Shoot Marshal, Referee (Trap or Skeet), Trappers etc. The Organising Committee plans to roster three referees to each trap field if at all possible.

Accommodation bookings are flowing into Ken Hawkings of Ansett, Sydney and intending visitors to Griffith are reminded that the people who book early will get the pick of the accommodation. There is no doubt that the crowd will overflow into Leeton, which is 57 kilometres away.

The organisers are confident that the 1979 Nationals will be the biggest and the best in the history of the Australian Clay Target Association. *The success will be accentuated by the attendance on Friday 10th March of the Honourable Ray Groom M.H.R., Minister for Environment, Housing and Community Development, who will officially open the Championships.* ARE YOU COMING TO GRIFFITH? ○

17.5  
5.79

# Editor's Mailbox

Dear Noel,

Having almost completed my list of thank-you letters to the various companies and individuals who made the U.S.A. trip such a success, it suddenly dawned on me that I have neglected the most important contributor to the whole operation.

The A.C.T.A. Management and Executive must be congratulated on their progressiveness in promoting international competition for the majority of Australian shotgunners, i.e. the "down the line" shooters, and I hope the team's bronze medal win will encourage further activities of this nature.

To represent my country in international competition was an honour which I did not hold lightly and I intend to wear my green and gold shooting jacket only on very special occasions.

Yours sincerely,

R. K. CARTLEDGE.

Dear Sir,

A great deal of concern is being expressed over the number of shooters failing to re-affiliate with the Association each year. As I see it the main problem is the high cost of competing and I think that Clubs in general are mainly to blame.

Some Clubs are charging up to \$6.00 for local or district championships and paying 1st, 2nd and 3rd outright, with a day's nomination approaching \$20.00. How these Clubs can expect the novice shooter to pay these high Noms. to compete with experienced shooters on an outright basis is beyond comprehension. The main complaint of the graded system in championships is, in a shoot-off, the 2nd placegetter often misses out, but if Clubs paid overall, A, B and C grade this criticism is resolved.

Recently Queanbeyan-Canberra Gun Club held a shoot where the program was organised to give small inexpensive engraved trophies for overall placings on the day of 1st, 2nd and 3rd in each grade along with High Gun, etc., and with the lowering of trophy values, the nominations were reduced to \$12.00 for 100 targets. The Club paid sweeps on each section of the program and comments from the competitors indicated that this is the way Club shoots should be arranged.

With the low current prices of targets there is no reason why most Clubs cannot throw targets at 15 cents each or say \$9.00 for a 60 target program, if they reduced the value of their trophies, and still make a profit for the Club.

I am not suggesting that all shoots be arranged in this way but if the Clubs held cheaper monthly shoots with perhaps once or twice a year holding a shoot with the big trophies and high nominations, I think the attendances would increase and the learner would receive more shooting which is what he needs.

To conclude, I think the management of Clubs would be helping the sport more by encouraging new members with cheaper shooting and more coaching, than grasping for more and more dates to run costly shoots on.

Yours sincerely,

D. R. HOPPER,

West Wyalong Gun Club.

(Ed. Note: Registrations exceeded 10,000 for the first time ever on 7th September, 1978!)

Dear Sir,

I have watched the unfolding of the "a shooter" saga with some interest and a lot of amusement. The suspense as to what form the documentary evidence could probably take, and the amusement at the hurt indignation expressed by some people at the thought that there may be a few one-eyed and/or incompetent referees among our ranks. Of course there are.

As a relative newcomer to this sport, it is evident that it would be difficult to find a sport more likely to be liable to controversy than Clay Target shooting. There is often quite a bit of money involved. The rules are shockingly badly phrased and set out, being quite ambiguous in a lot of cases. Referees are supposed to be able to judge the difference between 44.9 metres and 45.1 metres, and are given every opportunity to favour one person over another in their judgement of what constitutes a slow pull, if they are built that way.

To illustrate this, just after I joined my Club, I was told of a fellow who had just been diddled out of a win because his shoot-off competitor and the referee were bosom mates, and every time the

other bloke missed he was given a "no target". My informant and the person complaining are both members of a highly regarded profession, and I have no doubt that, in their minds the story was true (details available to my Committee if wanted). What probably happened was that the missed targets were being blown short or something of the sort. However the complainant had been about a bit and should have known a legitimate "no target" when he saw it.

Now as to the rules:— Not long ago a popular and capable referee-examiner was challenged, while refereeing skeet, by a visitor to the range, on his ruling on rule 26 in skeet. After the squad finished, the referee came into the office and borrowed a rule book. He read the rule, read it again, read it out loud, threw the book onto the table and said "what the so and so does that mean! These rules were written by a drunken darts player." And of course he is right.

Let's start with rules 6, 7 and 8, which define a legal target. Rule 9 then says categorically "The provisions of rule 6, 7 and 8 shall apply only in still air. Now to me this means that if a trap is throwing targets the right distance at the right trajectory, over the right range, in still air, it should be locked there and left there. It will continue to do just that until a breeze starts, when, according to rule 9, the distances, etc., in the previous rules no longer apply. But that is not what happens. The traps are set to throw a target conforming to the requirements for still air in whatever wind happens to be blowing at the start of proceedings. Referees are charged to see that the trap remains throwing "legal" targets, hence my statement that they must be able to tell the difference between 44.9 metres at which a target is short, and 45.1 metres at which a target is legal. That is rubbish. No one in the world could do that, and I will back that statement with my wallet. If traps were locked to throw a legal target in still air, the referee would only have to call a target which obviously deviated from the norm.

Concerning slow pulls. The rule says that a target shall be released "instantaneously." The difference in that word between a boxer, and an old bloke after his fifteenth go at the rum bottle could easily be half a second. Yet here is a sterling chance to favour your mate. There must be a better way.

Have you ever really read the definition of a baulk? To paraphrase, the book says it is "an extraneous occurrence which affects the equity of a competitor after he calls for his target." I bet that it means "an extraneous event which occurs after the competitor calls for his target, and which affects his equity." They are not the same thing by a long shot. Why not say what is meant and exclude room for argument?

The one referred to in the story of the referee-examiner. Rule 26 skeet reads: "the first competitor in a squad should be allowed to move across and stand at least three metres behind the next station from station 2 to 6 inclusive." Why not the second competitor too? The next station from 6 is station 7. How can a competitor stand three metres behind station 7 when there is a trap house in the way. All right, I can guess what is meant, but why not say it? What is the penalty for loading two rounds at singles station 7, or leaving your track at trap before the competitor to the right has fired? If there is no penalty, then those points should be among a "desirable behaviour" section and not in the "rules".

Now, as to referees, why is there not regular provision to advise all referees of any controversial points which may arise. As an example, some time ago, the top brass in my Club were discussing the correct call if a competitor called for his target and then shot the trap house. No answer was forthcoming until there had been considerable discussion and consultation of the book, etc., when it was decided that rule 36 probably meant it would be a lost target. Yet a month later, the identical incident occurred, and the referee involved, who has been around traps for many years and wears a referees badge allowed the competitor a go as if he had had a misfire in his second barrel. After this, I suggested to the powers that be that all referees should be advised of the incident. My suggestion got the same treatment as Poor blind Nell got from the sailor, and when that happens again, the referee still will not know what to do. (I refer to the suggestion that he should marry her).

To sum up, it should be possible to organise matters so that the referee is not required to judge distance and trajectory, only flight paths perhaps, to sort out the occasional "flyer" from wind affected targets. Allowing one second for release of trap targets, as is done in skeet, would get away from slow pulls, and while it would alter conditions slightly, the alteration would be the same for all competitors. Bear in mind, that in I.S.U. skeet, if a competitor

Cont'd on page 92.

# Victorian State Carnival

The Victorian State Carnival was at Bendigo and I went along with my friend Joe, we hadn't been to that Club before and we weren't real impressed with what we saw, I think fluorescent targets would have helped a lot 'cos quite a few targets at which we shot, couldn't be seen until they were well out and that they were missed, there's little doubt, trap four at the top was the worst and all that shot there liberally cursed.

Apart from that the shoot was run well and from looking at faces you could tell, who had shot well and who had shot poor, how they were going for the team with their score, when the team was announced there were happy faces from the fifteen shooters who had won the places, Later on Sunday when the teams match was done they announced that Neil Berry had won Team High Gun, it's great to see him shooting so well as he hasn't been round for quite a spell.

There's just one more thing I'd like to say about the winner of the Double Barrel on Saturday, "Mr Nice Guy" of shooting, Vin Ryan is his name he's one of the best in the clay busting game, now there is a shooter who's a gentleman as well from novices to veterans, the same tale they tell.

The Carnival's over for another year and the echo's have faded from our final cheer, all that's left is the memory of how we went whether our ego's swelled or took a dent, but I have to admit the whole shoot was fun and I'll be there next year with my trusty gun. ○

# More photo's from V.C.T.A. Carnival



● Mrs Iris McKay gets some good advice from the Victorian Clay Target Association's President Mr Robert F. Buchan.

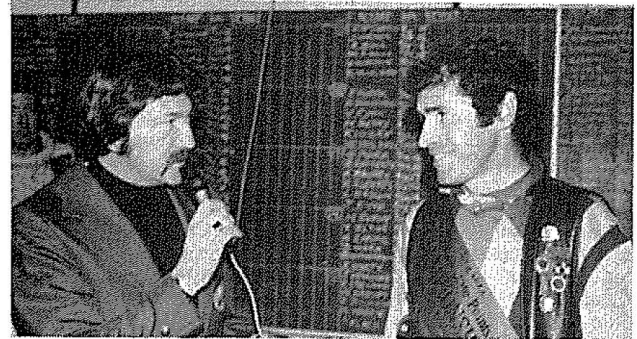

● From Boustead Trading, Mr Terry Roberts (left) presents Brian Rafferty, winner of the Victorian Points Score Championship with the Remington Trophy.

"GHOSTIE"

## COME TO NEW ZEALAND . . . with Jetset Tours and the A.C.T.A.

Groups will be departing from Brisbane, Sydney and Melbourne to compete in the New Zealand 1979 Clay Target Championships.

- Choose the exit point which is most convenient!
- COSTS — (Subject to currency fluctuations)**

Ex BRISBANE .....	Depart 23rd March, 1979	\$400
Ex SYDNEY .....	Depart 22nd March, 1979	\$400
Ex MELBOURNE .....	Depart 23rd March, 1979	\$410

Accommodation has been arranged only a short distance from the ground.

Further details may be obtained from your nearest Jetset Office, or the A.C.T.A. office at (03) 639777 or (03) 637596.

### Jetset Offices:

**MELBOURNE**  
Mrs Cherye Beilken  
18th floor  
M.L.C. Building  
303 Collins Street  
Tel: 62 0041

**SYDNEY**  
Mr Jeff Lurie  
22nd floor,  
M.L.C. Centre  
Cnr. King & Castlereagh  
Tel: 231 6955

**ADELAIDE**  
Stafford House,  
23-25 Leigh Street  
Tel: 87 3677

**PERTH**  
170 St. George's  
Terrace  
Tel: 21 4761

**BRISBANE**  
Ms Norma Davies  
M.L.C. Building  
Cnr. Adelaide & Edwards  
Tel: 229 2161

**BRISBANE**  
Newton Arcade,  
Stones Corner  
Tel: 397 9099

**TASMANIA**  
Trustees Court  
Launceston 7250  
Tel: 31 1822

**TASMANIA**  
A.M.P. Building  
86 Collins Street,  
Hobart 7000  
Tel: 34 8199

**WOOLONGONG**  
74 Crown Street,  
N.S.W. 2500  
Tel: 28 6777

**CANBERRA**  
1st Floor  
Florina Building  
Garema Place  
Tel: 47 6544

**ACT NOW!**

To qualify for low fares,  
bookings **MUST** be  
received before 26th January,  
1979.

# Queanbeyan-Canberra Gun Club

AFFILIATED WITH AUSTRALIAN CLAY TARGET ASSOCIATION

PRESENTS

## NATIONAL CAPITAL GRAND CHAMPION PROGRAM

SATURDAY and SUNDAY, NOVEMBER 25th - 26th

### SATURDAY commencing 1.00 p.m.

- Event One  
20 TGT DOUBLE BARREL 18 m C/D  
Nom \$4.00
- Event Two  
**ACT DOUBLE BARREL CHAMPIONSHIP**  
in conjunction  
**ACT LADIES DOUBLE BARREL CHAMPIONSHIP**  
and  
**ACT JUNIOR DOUBLE BARREL CHAMPIONSHIP**  
30 TGTS DOUBLE BARREL 18 metres  
Opt Sweeps 50c each half, 50c Overall \$1.50.  
Trophies: Red Sashes for Overall, Lady and Junior winners. PLUS 1st, 2nd, A B C Grades.  
Nom \$5.50
- Event Three  
20 TGT DOUBLE BARREL HANDICAP  
Opt Sweeps 50c each half, 50c Overall \$1.50.  
Trophies 1st, 2nd, 3rd, 4th, 11 metres, FM (11-13), Back Markers (21-25).  
Nom \$5.00

### SATURDAY NIGHT

- Event FOUR  
5 PR DOUBLE RISE 16 m C/D  
Nom \$2.00
- Event Five  
**SOUTHERN ZONE NIGHT DOUBLE RISE CHAMPIONSHIP**  
15 PAIRS 16 METRES  
Opt Sweep \$1.00 Overall (\$1.00). Trophies Sash for Overall winner. PLUS 1st, 2nd A B C Grades FM & 11 m  
Nom \$4.00

### SUNDAY commencing 9.00 a.m.

- Event Six  
20 TGT DOUBLE BARREL 16 M C/D  
Nom \$4.50
- Event Seven  
**CANBERRA DISTRICT DOUBLE BARREL CHAMPIONSHIP**  
in conjunction with  
**CANBERRA DISTRICT LADIES DB CHAMPIONSHIP**  
and  
**CANBERRA DISTRICT JUNIOR DB CHAMPIONSHIP**  
20 TARGETS DOUBLE BARREL 16 METRES  
Opt Sweeps 50c each half, 50c Overall (\$1.50).  
Trophies: Sashes for Overall, Lady and Junior winners. PLUS 1st, 2nd, A B C Grades.  
Nom \$5.50
- Event Eight  
**ACT POINT SCORE CHAMPIONSHIP** 30 TGTS, 18 METRES  
Opt Sweep 50c each half, 50c Overall (\$1.50).  
Trophies: Sash for Overall winner. PLUS 1st, 2nd A B C Grades.  
Nom \$5.50
- Event Nine  
**FAREWELL HANDICAP, 20 TGTS DOUBLE BARREL**  
Trophies 1st, 2nd, 3rd, 4th, 5th, 11m; FM 11-13; BM 21-25.  
OPT HIGH GUN SWEEP EVENTS 1-9 50c  
OPT LONG BREAK SWEEP 50c (Events No. 4-5 not included).  
Nom \$6.00

HIGH GUN SASHES A B C GRADES  
(To include Points on Event 8).

Total Nominations \$42.00  
Optional Sweeps \$8.00  
\$50.00

The Inaugural **NATIONAL CAPITAL GRAND CHAMPION** Title will be decided over this program on the four Championship **EVENTS 2, 5, 7, 8**. Trophies: 1st & Overall National Capital Grand Champion Cup; Medallions for 1st, 2nd, 3rd A B C Grades PLUS Lady and Junior winners. **NOTE: PROGRAM WILL BE CONDUCTED OVER FOUR TRAPS.**

Morning and Afternoon Teas available;  
Also Barbecue Lunch Sunday; tea available Saturday evening.

President: Merv Lyons,  
26 Cassidy Street, Queanbeyan.

Secretary: D. Newcombe,  
18 Battersby Crt., Kambah, A.C.T.  
Work Phone No.: 806844.  
Area Code 062; Home Phone No.: 310328.



## NEW SOUTH WALES

**BARELLAN, 10-9-78** — Fine, sunny (28). 10t EO: 4 divided K. Collins, Mrs K. Wardman, P. Jones, L. Irvin. 15t Trophy: 5 possibles L. Irvin, K. Collins, L. Brissenden; FM A. Raadgever; BM K. Whytcross; Lady Shooter Mrs K. Wardman. 10pr DR: 17-20 G. Dennis 16-20, L. McDonald, E. Wardman, N. McDermott. 10t Mxd. 5t off 11m 5t off 25m: 10-10 K. Whytcross, 9-10 G. Dennis, B. Simpson, E. Wardman, P. Jones, L. Brissenden, D. Allen, N. McDermott. 9t Quail Drive: 9-9 N. McDermott, 8-9 A. Bounds, E. Wardman, K. Collins, P. Jones, D. Allen, K. Whytcross, L. Irvin.

Congratulations go to Mr Les Irvin on winning his first High Gun.

**BERRIDALE, 9-9-78** — Clear, sunny day (33). 10t EO PS: equal 1st J. Williams, R. Hain, K. Woodhouse 30-30. 20pr Sthrn Dist DD Ch: B. Scanes and R. Mould, D. Badowitz and H. Kennedy. Wal Woodhouse Mem Hcp: D. Twigg, W. Mackay; FM R. Hain. High Gun: H. Tankey.

After all the terrible weather conditions we have experienced on our Shoot Days in the last few months it was very pleasing to have a fine sunny day on which to welcome visitors from Goulburn, Cowra, Canberra-Queanbeyan and Bombala. It was good to see so many shooters present in remembrance of one of the Club's foundation members and staunchest supporters' Mr Wal Woodhouse. Mrs Woodhouse has established a beautiful silver tray as a trophy in memory of her late husband and we were proud to have both she and her family present to present the trophies.

**BOMBALA, 16-9-78** — Fine (23). 10t DB: 1st divided O. Feilen, D. Badowitz, T. Peadon, T. Kennedy, J. Williams, G. Pagden. 5t SB 5t DB: "Club Trophy" won by Kay Wellmore. 15t DB: Rob Hain, John Peadon, Gordon Feilen. 6pr DD: 1st div Kay Wellmore and Tom Peadon, Os. Feilen and Clarrie McCarthy. 5pr DR: Jim Griffen, Os Feilen; FM Clarrie McCarthy. High Gun: Os Feilen.

Shooters present from Berridale, Queanbeyan, Bombala and quite a few from Bega where a new club is being formed.

**COBAR, 17-9-78** — Sunny (12). 5t EO CD: shot possible A. Brown, S. Osborne, G. Fennamore, L. Jenkins, A. Turner Snr. 20t DB Hcp Club Trophy: G. Betts, equal 2nd A. Brown, A. Turner Snr. 20t 18m PS: S. Osborne, A. Burgess, A. Turner Snr. 10pr DD: G. Fennamore and D. Osborne.

**COBAR, 25-8-78** — Fine (21). 20t DB NSW Jnr Masters: A. Turner (Cobar), W. Green (Corowa), S. Drawing (SAGC). 20t SB NSW Jnr Masters: J. Manns (Cobar), A. Turner (Cobar), B. Hipwell (Koyuga). 20t PS NSW Jnr Masters: A. Turner (Cobar), W. Green (Corowa), R. Thompson (Cobar). 20t

## DENILIKUIN GUN CLUB

### Sunday 19th November

**BBO LUNCH 12 NOON**  
**Shoot Commences 1.00 p.m.**

- |         |   |            |
|---------|---|------------|
| Event 1 | 10 TGT SILENT RISE E/O  | Nom \$2.50 |
| Event 2 | 20 TGT SILENT RISE CH.<br>1st Sash & Trophy,<br>2nd, 3rd & FM. O/S \$1. | Nom \$5.00 |
| Event 3 | 15 TGT HANDICAP TROPHY<br>1st, 2nd, 3rd & B/M. O/S \$1.                 | Nom \$4.00 |
| Event 4 | 10 TGT SB CLUB MUG  | Nom \$2.50 |

Afternoon Tea

Cartridges Available.

President:  
G. Daly.  
Phone (058) 811105.

Secretary:  
K. Bucholtz.  
P.O. Box 115,  
Deniliquin 2710.

**Champion of Champions**

To be contested by Shooters who have won an individual Championship at Deniliquin in 1978.

**FREE NOMINATIONS.**

## ILLAWARRA DISTRICT GUN CLUB

BONG BONG ROAD, DAPTO

### Sunday, 12th November

start 10.00 a.m.  
Event 1 Norm \$2.00

### 10 TGT E/O 18 m

(Noms close at 11.00 a.m.)

Event 2 Norm \$6.00

### JOHN ARKWRIGHT MEMORIAL SHIELD C'SHIP

20 Tgt off 18 m  
1st, 2nd, 3rd, F.M.

Event 3 Norm \$8.00

### ELEY PERPETUAL TROPHY

5 Man Teams, shot off 18 m  
Divided 1st Team 60%,  
2nd Team 40%

Event 4 Norm \$8.00

### 50 TGT KEMBLA GRANGE D.B. CHAMPIONSHIP

Shot off 16 m  
1st, 2nd, 3rd, F.M.

- ★ High Gun and Badge — Events 1-4
- ★ Optional Sweeps on all events.
- ★ Cartridges, Meals and Refreshments available.

President:  
W. Jones,  
10 Satinwood Ave.,  
Figtree. 2500.  
Ph: 28 8353.

Secretary:  
J. F. Maxwell,  
Lot 122 Susan Place,  
Farmborough Heights. 2526.  
Ph: 71 5472.



# HAWKESBURY GUN CLUB

Fairy Road, South Windsor

## STATE SKEET CARNIVAL 2nd and 3rd December, 1978

### Saturday 2nd December

commencing 10.00 a.m.

Event 1

Nom \$10.00

#### 50 T Graded Skeet Trophy

Overall 0-1, 2-4, 5-10. OS each 25 T, \$1 O.S. Overall \$1. (**\$3.00**)

Event 2

Nom \$12.00

#### 50 T Hawkesbury Gun Club C'ship

1st, 2nd and 3rd. O.S. each 25 T \$1, O.S. overall \$1 (\$3.00)

★ State Teams selection in conjunction

### Sunday 3rd December

commencing 10.00 a.m.

Event 3

Nom \$12.00

#### 50 T State Skeet Championship

1st, 2nd and 3rd. O.S. ea 25 T \$1, O.S. Overall \$1 (\$3.00)

Event 4

Nom \$12.00

#### 50 T Winchester Skeet Trophy

1st, 2nd and 3rd. O.S. ea 25 T \$1, O.S. Overall \$1 (\$3.00)

High Gun Over Events 1 2 3 & 4  
WINCHESTER PIGEON GRADE U/O SKEET GUN

Shields to be shot in conjunction:

- (a) Olympia Shield — Hawkesbury v Wagga Wagga — Events 1 & 2
- (b) Zone Teams — Hawkeye Shield — Event 3.
- (c) Winchester 500 — Southern Zone v Riverina — Events 2 & 3.

ACCOMMODATION: T. Patterson 628 8385 CARAVAN SITES AVAILABLE.

President:  
R. Walker.  
Phone 047-541324.

Secretary:  
R. Greenwood.  
Phone 047-214220.



Established 1880

# N.S.W. GUN CLUB

CORDIAL INVITATION IS EXTENDED TO

## ★ 4th ANNUAL

PROCEEDS IN AID OF AUTISTIC CHILDREN

★ TROPHIES VALUE \$2,500 ★

RED FLUORESCENT TARGETS SUPPLIED FREE

**SATURDAY, 11th NOVEMBER 1978 — Start 10 a.m.**

(Nominations for Event 1 close 12 noon)

Event 1

Nom \$6.00

### 30 T DOUBLE BARREL HANDICAP TROPHY

1st: Krico Magnum .22 De Luxe Rifle

2nd: Bond Worth Carpet

3rd: Binoculars

Back Marker Trophy 20-25 m

O.S. \$3.00

Ladies Trophies 1st and 2nd.

Juniors Trophies 18 and under 1st and 2nd

O/S \$1.00 each 15 targets and Overall.

Event 2

Nom \$4.00

### 20 TARGET POINTS SCORE CHAMPIONSHIP

Sash Overall winner.

O.S. \$1.00

Trophies to 1st, 2nd and 3rd in each grade A, B & C.

Event 3

Nom \$4.00

### 20 TARGET SINGLE BARREL CHAMPIONSHIP

Sash Overall winner.

Trophies 1st, 2nd and 3rd in each Grade A, B & C.

O.S. \$1.00

HIGH GUN OVER EVENTS 1 - 3

INTERMEDIATE HIGH GUN (11-15m) OVER EVENTS 1 - 3

LADIES HIGH GUN OVER EVENTS 1 - 3.

High Gun over Events 4 - 6: Winchester .22 Rifle.

Intermediate High Gun (11-15m) over Events 4 - 6.

Ladies High Gun over Events 4 - 6

OPEN HIGH GUN OVER EVENTS 1 - 6.

INTERMEDIATE HIGH GUN (11-15 m) over Events 1 - 6.

LADIES HIGH GUN over Events 1 - 6.

(Point Score Event 2 — to count over whole program in determining High Gun Winners).

In Handicap Events Shooter can win one trophy only.

Meals, Cartridges & Components available.  
Fully Licensed Club House.

## LIST OF DONORS OF

A. & R. Alvaro — Alvaro Bros. Const  
 K. Biggs — United Technologies  
 W. Bruce — Parramatta Gun Store  
 R. Darwon — Smith's Sport Store  
 D. Duffy — Colonial Gun Shop  
 D. Durrant — F. C. Lovelock  
 M. Fuller — Fuller Firearms Co.  
 P. Heath — Night & Day Pharmacy, B  
 R. Hepworth — Custom Auto Moulding  
 R. Jones — Bond Worth Carpets Co.  
 E. Kavanagh — Kavanagh Installation  
 P. Lee — P. Lee & Associates  
 K. Loy — Loy Arms Co.  
 P. McBeath — Momac Engineering Co  
 L. McKenzie — Witch Engineering Co  
 D. Mackie — Brooklyn Hardware Store  
 J. Rhodin — Rhodin Motors  
 B. Smith — N. & S. Gunsmiths  
 M. Smith — Smith's Sport Store  
 F. Ward — Mote Ladders  
 S. Zuffo — Olimpyc Targets Co.  
 G. Bedington R. Clarke  
 R. Beer B. Conduit  
 C. Brown J. Cooper  
 T. Budd R. Crumpton

131 BOORALIE ROAD, TERREY HILLS 2084  
TURN OFF MONA VALE ROAD AT TERREY HILLS SHOPPING CENTRE

ALL CLAY TARGET SHOOTERS TO PARTICIPATE IN . . .

# CHARITY CARNIVAL ★

ASSOCIATION AND LOCAL CHARITY ORGANISATIONS

★ 1/2 **NOMINATION COST** ★

BY OLIMPYC TARGET CO. WILL BE USED THROUGHOUT

**SUNDAY 12th NOVEMBER 1978 — start 10 a.m.**

**TROPHIES at as 25-9-78**

(Nominations for Event 4 — close 11 a.m.)

Event 4 Nom \$4.00

## 20 TGT DOUBLE BARREL CHAMPIONSHIP

Sash O/all winner. Trophies to 1st, 2nd and 3rd in each grade A, B & C; Trophy to Top Lady Shooter.

K. Davis  
N. Doubleday  
R. Droder  
J. Guberina  
A. Freeman  
C. Hawkins  
G. Hitchin  
C. Hlavaty  
A. Jericevich  
A. Kavanagh  
G. Lane  
P. Lever-Naylor  
R. McAllister  
R. McCathie  
I. McLeay  
D. Metzler  
C. Naudin  
R. Northcott  
E. O'Heaney  
G. O'Neill  
J. Philippon  
F. Raanhuis  
W. Reid  
J. Richardson  
A. Romanello

nkstown

C. Spence  
C. Wade  
R. Ward  
J. Worley

Event 5 Nom \$6.00

## GRAND CHARITY HANDICAP

### 30 T Double Barrel from A.C.T.A. Handicap

1st: Stirling Classic Auto Shotgun; 2nd Radar Detector; 3rd: Tissot Automatic Men's Watch; 4th: Texan F.W. Reloader; 5th: Digital Clock/Radio.

Ladies Trophies: 1st chest of gourmet quality meat, Trophies to 2nd and 3rd place. Juniors: Engraved silver cup for 18 years and under. Winner 16 years and under: Jeans for all children under 16 years in the family. Seniors: 60 years and over: Trophy to 1st and 2nd.

O/S \$1.00 on each 15 Targets and Overall.

Event 6 Nom \$4.00

## 10 pairs DOUBLE RISE CHAMPIONSHIP

Sash O/A winner. Trophies to 1st, 2nd & 3rd in each grade A, B & C

Event 7 Nom \$4.00

## 20 pairs DEAUVILLE DOUBLES CHAMPIONSHIP

Sashes to winning double. Trophies to 1st, 2nd & 3rd double.

Optional Sweeps Events 4 6 7 \$1.00; Event 5 \$3.00.

PRESIDENT:  
Charles Hlavaty.

N.S.W. GUN CLUB CONTACT  
(in residence)  
Guy Bedington  
Phone (02) 450 1775.

Jnr Cont Hcp: equal 1st R. Thompson (Cobar), S. Drawing (SAGC), W. Green (Corowa). OA High Gun NSW Jnr Masters Ch of Ch: A. Turner (Cobar).

J. Manns (Cobar) lost 1 metre from 11m to 12m. K. R. Soames NSW Reg No. 012826 was changed from 11m to 16m by A. M. Burgess (Cobar) as he was underhandicapped because of his previous trap experience.

**COBAR, 25-8-78** — Clear (63). 20t Far Western District DB Night Ch 16m: OA & 'A' N. Williamson (Condobolin), 'B' R. Lehman (Lightning Ridge), 'C' W. Green Jnr (Corowa). 20t Far Western Dist SB Night Ch 16m: OA & 'A' L. R. Brown (Lake Cargelligo), 'B' A. Eves (Cobar), 'C' R. Thompson (Cobar).

**COBAR, 26-8-78** — Fine and sunny (77). 20t Far Western District DB Ch 16m: OA & 'A' B. Walton (Gilgandra), 'B' D. McKenzie Snr (West Wyalong), 'C' A. Turner Snr (Cobar). 20t Far Western Dist PS Ch 16m: OA & 'B' R. Lehman (Lightning Ridge), 'A' J. Mann Snr (Cobar), 'C' M. Charlesworth (Melb). 40t "Mafeesh" \$1000 Cash Hcp: cup winner (from shoot-off) S. Osborne (Cobar); equal 1st for CD: J. Lansbury (Singleton), S. Osborne (Cobar), S. Drawing (SAGC), T. Vincent (Broken Hill), M. Charlesworth (Melb), J. Pateman (Crookwell), R. Watchorn (Illawarra), D. Balson.

**COBAR, 27-8-78** — Fine, light breeze (77). 60t Copper City Hcp: 1st OA G. Jones (Cobar); 11-14m L. Siebert (Broken Hill), D. Farrell (Bourke), R. Honeyman (Bourke); 15-18m J. Pateman (Crookwell), B. Smith (Goodooga), S. Drawing (SAGC); 19-21m V. Flower (Taree), J. Manns Snr (Cobar), R. Machul (Broken Hill); 22-25m D. Osborne (Cobar), K. Loy (Sydney), B. Walton (Gilgandra). Highest score 11m shooter donated by D. Osborne won by L. Siebert. 20t Far Western Dist SB Ch: OA A. M. Burgess (Cobar), 'A' D. Cosgrove (Warren), 'B' B. Woodward (Melb), 'C' K. Soames. High Gun: R. Honeyman (Bourke).

**COFFS HARBOUR, 26-8-78** — Fine (29). 10t DB CD: D. Muller, R. Hammond, A. Mitchell 10-10. 30t DB Nthrn Rivers Ch: OA S. Saul 36-36, 'A' R. Hammond 60-62, 'B' R. Boyes 35-36, 'C' W. Wiegold 28-30. 5t DB Trophy: R. Boyes 5-5. 20t PS Hcp: C. Fuller 19-57, R. Hosking 19-55, A. Wenban 19-54. 10pr DR: 11-14m P. Sanderman 16-20, B. Wenban 19-20, H. Siddins 17-20.

**COFFS HARBOUR, 27-8-78** — Cold & windy (26). 10t SB CD 16m: A. Wenban 10-10, R. Hammond, B. Wenban, K. Thornton, A. Hine all 9-10. 30t SB Nthrn Rivers Ch: OA K. Thornton 29-31, 'A' R. Hammond 28-31, 'B' E. Simmon 28-30, 'C' J. Cunningham 26-30. 10t DB CD: B. Wenban, H. Siddins, K. Thornton, A. Hine 10-10. 30t DB Hcp CD: J. Cunningham 29-30, R. Hosking 28-30, A. Witt 27-30. High Gun: R. Hammond 139-150.

**COROWA, 2-9-78** — Warm and sunny (32). 10t DB Hcp CD: 9 shooters shared the division. 20t DB Hcp Trophy: R. Gulliver 14m 36-36, G. Walls 13m 35-36, T. Valentine 12m 29-36. 20t DB Hcp Trophy: W. Green 15m 50-50, G. Walls 13m 49-50, G. Moore 16m 26-50. 10t DB Hcp SS: 13 shooters shared the division. Lady Shooter: L. Taylor 12m; Schoolboy: G. Litt 12m; FM: W. Buck 12m; BM: A. Jamieson 17m.

Although the numbers were down on past shoots, the performances from most of the shooters was first class, with scores being pretty even all day. All in all the day proved most enjoyable with fine weather and fine shooting.

**COWRA, 2-9-78** — Fine and mild (85). 15t CD Welcome SS: F. Rapley, C. Hawkins, R. Northcott, E. Vincent, J. Hayes, W. Jones, L. Scott, O. Feilen, R. Stockton, D. Menck, D. Badewitz, R. Taylor, A. Ambs, J. Curran, R. Piotrowski. Lachlan Valley DB Ch: 1st & badge W. Jones 97-97, 'A' R. Northcott 96-97, 'B' A. Ambs 37-38, 'C' S. Beasley 24-25. 15t Sweep: G. Marshall, H. Anderson, K. O'Brien, J. Crockett, J. Hayes, G. Brunton, L. Scott, T. Hayden, R. Stockton, B. Beasley, N. McDermott.

Night — Central Tablelands DB Ch: 1st & badge winner J. Hayes, 'A' L. Arnold 25-26, 'B' L. Chodat 42-43, 'C' N. Dwight 25-27.

**COWRA, 3-9-78** — Rain and cool (82). 15t 16m Welcome Sweep: P. Bortolini, J. Smith, C. Hawkins, D. Wood, T. Hayden, P. Heterick, J. Blain, A. Ambs, W. Jones, R. Hunt, A. Povey, D. Badewitz. Lachlan Valley SB Ch: 1st & badge A. Hayes 22-22, 'A' W. Jones 21-22, 'B' A. Ambs 24-25, 'C' T. Tindal 27-28. Eley Perpetual Trophy Team Event: 1st Illawarra No. 1; runners-up Cowra No. 1, Hawkesbury Blue, Leeton. Eley Gold Cup: 1st Hawkesbury Blue, 2nd Orange, 3rd Cowra No. 3. Intermediate High Gun J. Williams; High Gun J. Hayes (Goulburn).

**DOWNSIDE INTERNATIONAL, 26-8-78** — Fine and cold (37). 5t EO DB Hcp: R. Rixon, B. Coleman, B. Hall, W. Scott, R. Patterson, A. McKenzie, J. Geale, B. Stubbs, J. Wilson, T. Atkinson 5-5. 15t DB Trophy Hcp: OA S. Wilson, 11-14m L. Blake, 15-18m R. Tye, 19-25m R. Blake. 20t \$150 DB Hcp: S. Wilson and J. Geale 20-20, P. Shephard, W. Scott, R. Patterson, P. Scott

## DOWNSIDE INTERNATIONAL GUN CLUB

(Affiliated A.C.T.A.)

Club situated 16 km north of Wagga on Coolamon Rd.

### SATURDAY 25th NOVEMBER

start 1.00 p.m.

- |         |  |            |
|---------|--|------------|
| Event 1 | 5 T Eye Opener Cont. P/S off 18m CD  | Nom \$1.00 |
| Event 2 | 30T Central Riverina P/S Cont. Championship off 18m 50c OS each 15. Sash OA. Graded. | Nom \$5.00 |
| Event 3 | 15T Trophy Handicap  | Nom \$2.50 |

- |         |   |            |
|---------|---|------------|
| Event 4 | 50c OS 1st, 2nd & 3rd Trophies. F.M. 11-12m, Ladies 11-14m. | Nom \$4.00 |
|---------|---|------------|

20T D.B. Handicap in conjunction with BOOMERANG SHIELD OS 50c each 10, 1st, 2nd, 3rd Trophy, F.M. 11-12m. 50c each shooter team 5.

HIGH GUN EVENTS 1-4  
Other events time permitting.  
Refreshments, Cartridges Available.

### SATURDAY 2nd DECEMBER

start 9.30 a.m.

- |         |  |            |
|---------|--|------------|
| Event 1 | CHAMPION OF CHAMPIONS  | Nom \$5.50 |
|         | 30T K. & B. Caravans D/B C'ship                                    |            |
|         | OA Sash & \$50 Trophy. Trophies A B & C \$50 each. OS 50c each 15. |            |

- |         |  |            |
|---------|--|------------|
| Event 2 | 30T Pioneer Concrete P/S C'ship                                    | Nom \$5.50 |
|         | OA Sash & \$50 Trophy. Trophies A B & C \$50 each. OS 50c each 15. |            |

- |         |   |            |
|---------|---|------------|
| Event 3 | 30T Downside & District SB C'ship                     | Nom \$5.50 |
|         | OA Sash & \$50 Trophy. Trophies A B & C \$50 each 15. |            |

- |         |  |            |
|---------|--|------------|
| Event 4 | 15PR K. & B. Caravans D/R C'ship                   | Nom \$5.50 |
|         | OA Sash & \$50 Trophy. Trophies A B & C \$50 each. |            |

Champion of Champions Shoot will consist of 40 Targets - 10T D/B, 10T P/S, 10T S/B, 5PR D/R. Shooters to qualify for this event will be Overall & Grade winners Events 1-4. Nominations

Sash OA. Badges A B & C.  
HIGH GUN OVER EVENTS 1-4.

### SUNDAY 3rd DECEMBER

start 9.30 a.m.

- |         |   |             |
|---------|---|-------------|
| Event 1 | 100T Olympic Trench C'ship                                    | Nom \$17.00 |
|         | OS 50c each 25, 50c OA. Sash OA. 1st & 2nd Trophy each grade. |             |
| Event 2 | 50T Downside & District Skeet C'ship                          | Nom \$8.00  |
|         | Sash OA. Graded.  |             |

Refreshments - Lunch - Cartridges.

The committee reserves the right to alter program if necessary:  
President: J. Stewart, Secretary: Mrs L. Parr,  
Craft Street, 57 Trail Street,  
LAKE ALBERT. WAGGA WAGGA.  
Phone 22 5141. Phone: 21 1475.

## MARCONI GUN CLUB SUNDAY 26th NOVEMBER '78 FINAL OF ALITALIA CUP

(Not 22nd October as shown on page 76 of October CTSN)

Visit by members of  
International Gun Club, S.A.

# FOUR GUNS ON ONE EVENT !!

**GRAND  
S K B  
HANDICAP**

**GRAND  
S K B  
HANDICAP**

**AT**

## **ROYAL AERO CLUB OF N.S.W.**

### **SUNDAY, 3rd DECEMBER, 1978**

Event 1	<b>EYE OPENER C.D.</b>	Nom \$3.00
Event 2	<b>GRAND SKB HANDICAP</b> SKB GUN ON EACH HANDICAP GROUP 11-14, 15-18, 19-21, 22-25 metres. PLUS Great Second Prize in each Group.	Nom \$15.00
Event 3	<b>SKB CONSOLATION CHAMPIONSHIP</b> 16m GRADED A B and C Great Trophies 1st & 2nd each Grade.	Nom \$10.00
PLUS Event 4	<b>COMMONWEALTH DEAUVILLE DOUBLES CHAMPIONSHIP</b> HIGH GUN OVER EVENTS 1, 2 AND 3. OPTIONAL SWEEPS EVENTS 2, 3 and 4.	Nom \$9.00

**COMMENCES 10 A.M. SUNDAY, 3RD DECEMBER, 1978**  
**ROYAL AERO CLUB OF N.S.W. — WESTERN END OF MARION STREET,  
BANKSTOWN.**

LICENSED CLUB — ALL MEALS — ACCOMMODATION  
Ammunition Available — Hot and Cold Snacks Available All Day.

CHAIRMAN:  
Peter Heath  
Phone 969 5465.

DEPUTY CHAIRMAN:  
Harry Somers  
Phone: 969 9339.

# FOUR GUNS ON ONE EVENT !!

19-20. 15t PS TROPHY Hcp: OA S. Wilson, 11-14m C. Blake, 15-18m W. Scott, 19-25 R. Fox. Lady's Trophy: J. Alexander; FM D. Harvey; High Gun: S. Wilson.

Congratulations to S. Wilson on winning the High Gun — only three targets down for the day. S. Wilson, J. Geale, C. Blake and J. Alexander all penalised one metre.

**DOWNSIDE INTERNATIONAL, 3-9-78** — Showery (30). 50t Trench Ch: OA & 'B' A. Bound (Barellan), M. Holden (Ganmain); 'A' B. Hall (Downside), P. Wheeler (Downside); 'C' A. McKenzie (Downside), S. Wilson (Downside). 25t Trench Trophy: 'A' L. Arnold (Bathurst), 'B' A. Bound (Barellan), 'C' L. Graham (Ganmain).

Despite unsettled weather conditions shooters travelled from Bathurst, Condobolin, Parkes, Barellan, Griffith, Ganmain, Wangaratta, Yarrowonga and Downside.

**DUBBO, 3-9-78** — Bleak; wet and windy (40). 10t DB Gun Down: C. Doorman 9, K. Dowton 8, T. Bourke 8. 10t Quail Drive: M. Roberts 7, E. Tucker 7, J. Smith 7, R. Carr 7. 10t DB Hcp EO: A. Bourke 10, M. Perring 10. 10t DB 10pr DD: A. Bourke and E. Tucker 9, C. Doorman and R. Carr 9. 15t DB PS: M. Perring and C. Doorman 42-45; shoot-off M. Perring 1st, M. Roberts 41-45. 10t DB 16m: G. Marr 10, A. Perring 10, E. Tucker 9, R. Carr 9.

Bleak day, good family attendance with Colin Doorman the steadiest shooter of the day.

**DUBBO, 10-9-78** — Fine and warm (60). 40t DB 16m: 'A' D. Cosgrove (Warren), 'B' R. Carr (Gulgong), 'C' K. McCumstie (Condobolin). 40t DB Hcp: R. J. Smith (Dubbo), T. Bourke (Dubbo), S. Wilson (Downside Inter.). High Gun: R. Duncan (Cobar); Inter High Gun: K. McCumstie (Condobolin). Hcp prizes: 11-13m K. McCumstie, 14-16m M. Nobes (Cowra), 18-20m T. Golding, 21-25m R. Duncan (Cobar).

A great family day with all proceeds going towards the Travel Fund.

**FINLEY, 27-8-78** — Fine and windy (52). Riverina Zone Trap Elim Sh 25t DB 25t SB 25t Pts: B. Duncan 121-125, K. Bucholtz 145-150, F. Burns 143-150, R. Blake 142-150, L. Anderson 137-150; 11-12m G. Craze 116-125. 15t Hcp: K. O'Brien 23-23, P. Barkley 22-23, T. Salafia 18-19.

**FINLEY, 10-9-78** — Cloudy (51). Finley Cent DB Ch: V. Ryan 101-101, R. Newby 100-101, J. Whittakers 98-99; 11-12m K. O'Brien 18-20. Finley Cent. Hcp: P. Barkley 98-98, A. Jamieson 97-98, R. Newby 51-52; 11-12m K. O'Brien 19-20.

**GANMAIN, 30-7-78** — Fine (42). 10t SB 18m: 2 possibles. 20t SB 18m Riverina Zone Ch: J. Parr, A. McKenzie, L. Graham; FM J. Lugton; Ladies Mrs Alexander. 10t DB 16m: 13 divided. 20t DB Central Riverina PS: J. Blain, L. McDonald, L. Graham; FM J. Lugton; Ladies Mrs Alexander. 20t Hcp 3 divide. High Gun: J. Blain.

**GANMAIN, 5-8-78** — Fine (40). 5pr DR: 4 at 8-10. 10pr Trophy: J. Parr, M. Evans, B. Blake; FM B. Tilyard; Ladies Mrs Charles. 20t 16m: 2 possibles. High Gun: B. Blake.

**GANMAIN** — Fine (37). 10t Cont Double Barrel: six divided. 20t DB Cont Trophy: B. Blake, G. Dennis, R. Patterson; FM B. Tilyard. 10t PS: 3 divided.

**GRAFTON, 3-9-78** — Fine 25°C. (26). 10t DB Hcp SS: 10-10 K. Handsaker Snr, P. Sandeman, R. Boyes, G. McGuren, T. Ryder, T. Watts, L. Geary, M. Geary, N. Watkins, R. Couttsmith, R. Starr. 10t PS Hcp SS Trophy: G. Lawrence 13-39, P. Sandeman 13-38, T. Ryder 12-33. 10t SB 16m SS: K. Handsaker Snr 10-10, L. Geary 10-10. 20t DB 18m SS: R. Boyes 20-20, J. Farrell 19-20, B. Huddleston, M. Wilson, G. Lawrence, R. Starr 18-20. High Gun: R. Boyes 48-50; Secret High Gun Pat Geary.

Evidence of a perfect day for shooting was shown by the results of the No. 1 event, where 11 shooters shot the possible; also a good performance by Coffs Harbour shooter Rex Boyes with an overall score of 48-50 to take out the High Gun.

**GRIFFITH, 3-9-78** — Cold, with showers (35). 10t DB EO: 8 divided. Club DB Trophy Event 25t: 11-15m Hcp W. Carlon, 16-19m hcp D. Wallace, 20-25m hcp B. K. Brown. 10t DB 16m: 9 divided. M.I.A. DB Ch 16m: A. Poanne, S. Papisdro, T. Salafia; FM E. Cacopardo; High Gun: D. Wallace.

**GRIFFITH, 16-9-78** — Sunny and cool (25). 25t Skeet EO SS: 6 divided. 50t Club Trophy in conj with Riverina Zone Skeet Team Elim: 0-1 Hcp B. Rooke; 2-3 hcp P. McWilliams, 4-10 hcp B. Bartholomew; High Gun B. Rooke. Riverina Zone Skeet Team - B. Rooke 50-50, C. Strike 49-50, T. Salafia 48-50, D. Lucas 46-50, P. McWilliams 46-50, D. Wallace 45-50.

**GUNNEDAH, 9-9-78** — Warm and calm (32). 10t DB EO: K. Buckley shot the only possible. 9-10 N. Bradbury, B. Finlay, J. Rose, R. McPherson, L. McMaster, G. McPherson, S. Staughton, V. Eather, P. Proudfoot, B. McPherson. 20t DB Liverpool Plains Ch: P. Proudfoot shot the only possible. 2nd S. McMaster, 3rd R. Cross. S. Eather and B. McPherson were in the shoot-off but missed birds in the early stages of the shoot-off. 10t SB: no possibles. 9-10 T. Perrett, K. Shaw, G. Bardon, G. Torrens, V. Eather. 10t DB Novelty Event: when a shooter missed his first target he was eliminated. Those to score 10-10 were N. Bradbury, R. McPherson, G. Bardon, S. Tydd, S. Staughton, P. Proudfoot, G. Goscomb.

Shooters scores were very low as indicated by the few possibles. Orange clays were used for the first time and perhaps the bright colors appearing dazzled the shooters. Some excellent shooting by Peter Proudfoot to win the Championship outright. It is hoped that by next shoot the new Winchester Trap will be installed and in working order. The new trap is a Continental and will test the skills of the shooters even further. If the present poor shooting continues it is doubtful if any member will be able to score a possible.

**ILLAWARRA DISTRICT, 26-8-78** — Windy (16). Skeet Hcp: R. Peters 29-29 L. Chodat 26-27, J. Maxwell 25-26. 25t Avon Skeet Ch: J. Maxwell 24-25, L. Stalling 23-25, D. Watchorn 21-25.

# GALA DAY

## MARCONI GUN CLUB

Sydney-Marconi Clay Target Complex  
HEATHCOTE ROAD, MENAI.

### Sunday 26th November

10 a.m. start

## MARCONI GUN CLUB v INTERNATIONAL GUN CLUB (SA)

\*\*\*\*\*

Teams representing the two clubs will compete for the Winchester Perpetual Trophy donated by Winchester (Australia). Marconi will make a return visit to International G.C. (S.A.) in 1979.

Event 1 Nom \$10.00

**MARCONI/INTERNATIONAL  
D/B CHAMPIONSHIP**  
50 T D/B 16 m  
O/S \$1 each 25 \$1 OA.

Event 2 Nom \$6.00

**MARCONI/SOUTHERN DISTRICTS  
MIXED TARGETS C'SHIP**  
Sash to O/A winner.  
O/S \$1.

Event 3 Nom \$5.00

**CLUB CONTINENTAL  
D/B CHAMPIONSHIP**  
20 T D/B 16 m  
Badge to O/A winner.

Trophies 1st & 2nd A B C Grades.  
Winchester High Gun over Events 1-3

Trophies in Event 3 donated by: Metropolitan Truck Wreckers, Great Western H'way, Wentworthville; Mick Stevens Viscount Caravans, Church Street, Parramatta; Clarevale Wines (Sydney) Pty. Ltd., Beaconsfield Street, Auburn.

★ Final Event for 1978 Alitalia Cup ★

President:  
L. CREMA.  
Phone 604 0125.

Secretary:  
N. BANKO.  
Phone 728 1690.

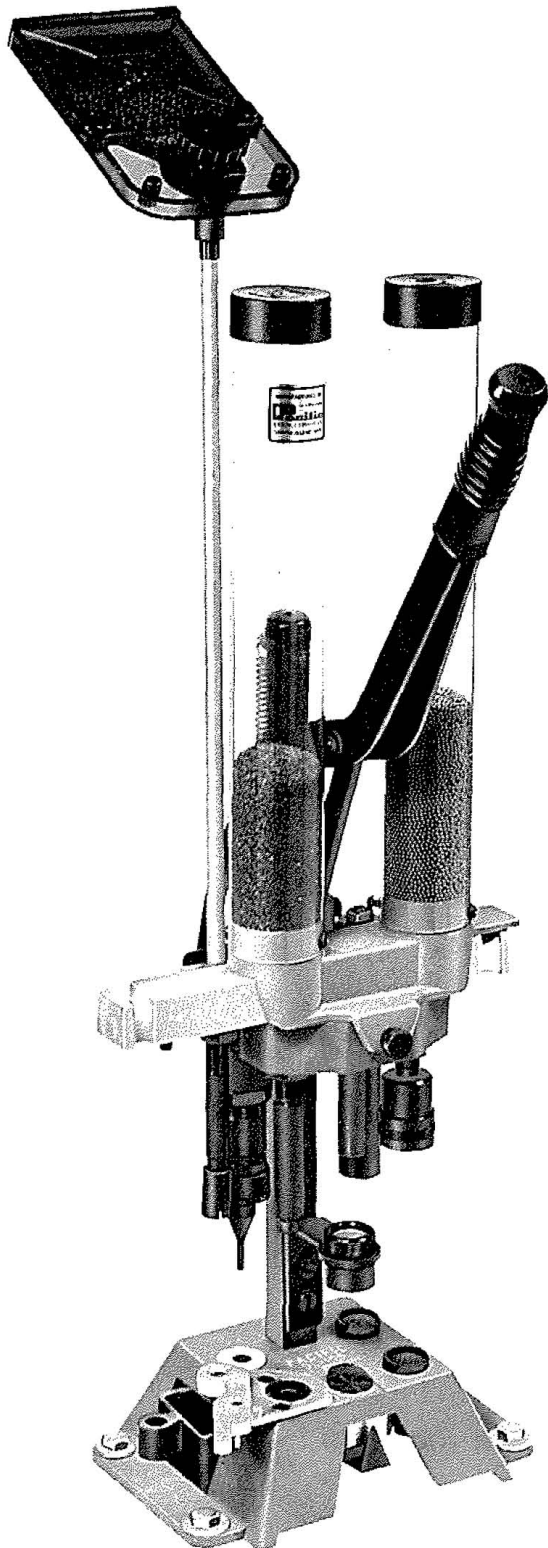

155 APF SHOTSHELL RELOADER  
(pictured)

Div of **Hornady**

# Pacific

# 155

## APF

## SHOTSHELL RELOADER

Pacific's 155 is designed for the average shooter, but the only thing average about this reloader is its price. When you compare all reloaders in the 155's price range, you'll rate the 155 tops in all-around performance.

Shooters who reload everything from 12 gauge goose loads to 410 gauge skeet loads will find plenty of versatility in the 155, in addition to fast, easy operation. Pacific's 155 is a top-quality reloader, carefully manufactured of finest materials to provide many years of heavy service.

- Produces factory-like reloads. Resizes entire length of shell, including head and rim. Spring-loaded finish die produces perfect tapered crimp.
- Versatile—113 interchangeable shot and powder bushings give you a wide selection of loads (see page 38). The 155 handles both plastic and paper shells of all base wad types and all brass heights. Quick-change Die Sets let you load everything from 3-inch 12 gauge shells to 2½-inch 410 gauge shells.
- Top-quality materials and workmanship. Dies are polished steel with deep blue finish (no decorative chrome plating to flake and peel). Base and die head are large, heavy-duty castings.
- Foolproof charge bar. Bushings cannot be accidentally reversed in charge bar, and powder-shot charging sequence cannot be unintentionally interrupted.
- All operations end on a positive stop, including fully adjustable wad seating. Clevis-type ejector effortlessly ejects shell from resize die.
- In-line Automatic Primer Feed (APF model pictured) is safe and jam-free; includes Primer Tube Filler. APF Conversion Unit may be added later to 155.
- "Floating" crimp starter automatically seeks out original crimp folds. Interchangeable crimp starter inserts (8-point, 6-point, and paper roll crimp) furnished with loader.
- Large-capacity hoppers keep you loading without interruption. Wide mouth allows quick refilling. Unbreakable primer catcher is standard equipment.

155 APF  
SHOTSHELL RELOADER..... 12 & 20 Ga. ....  
..... 16 & 410 Ga. ....  
Complete with standard charge bushings.

*Available from leading Sports Stores*

SOLE AUSTRALIAN AGENTS:

**KEITH HERRON** PTY. LTD.

P.O. BOX 61, PUNCHBOWL,  
N.S.W. 2196. Phone 02-7500170, 02-7593665.

# Too good





# to miss.

Starting now, there is a range of trap cartridges on the market which bears a famous name and sells for an unheard of price.

The name is Eley. The price is only slightly above that of reloading. Eley are the first to be able to offer premium quality trap cartridges at a less than premium price. The others will probably follow suit.

But only Eley can offer the 151 years of experience behind every cartridge they produce.

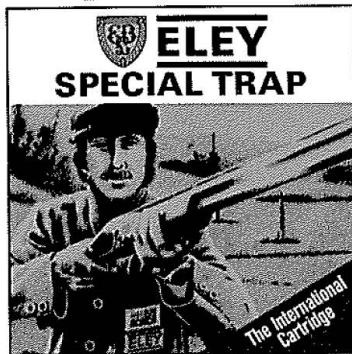

Smooth shooting, with a dense even pattern for breaks like 620/620 (1974 National Double Barrel Title). 32g shot in size 7, 7½ and 8.

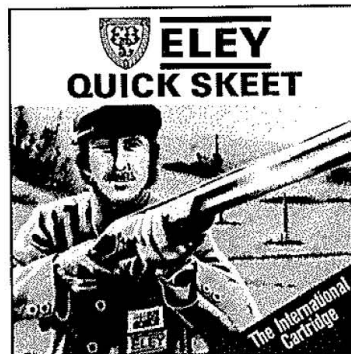

A fast, hard hitting "widespread" pattern with lower recoil to reduce muzzle flip. 32g shot size 9.

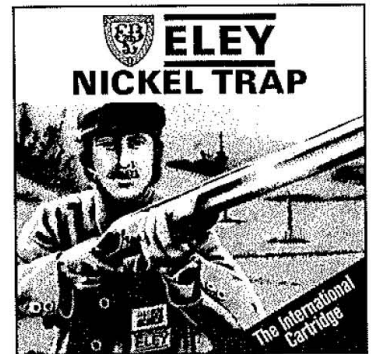

High velocity, extra hard nickel shot to meet new clay specifications 32g shot in size 7½.

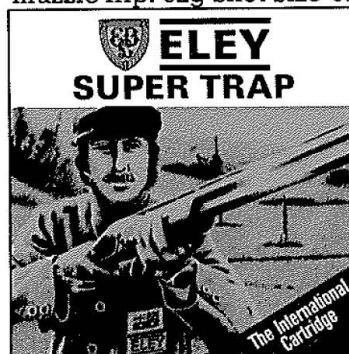

Proved at International competition level for its speed and pattern consistency. 32g shot in size 7, 7½ and 8.

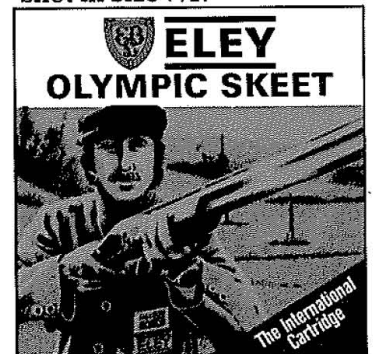

"Widespread" shot pattern for brilliant performance in ISU and American Skeet Competition. 32g shot in size 9.

A reputation for power, pattern and performance.

And the trap shooting expertise which has led to championship after championship at National and International level.

Take advantage of Eley premium trap cartridges - at a price that makes reloading hardly worthwhile. They're at your usual Eley stockist. You can't miss.



## ELEY

151 years of experience.

# Here's a sporting proposition for you!



If you're in a sporting team which is going places, you need an airline that's used to flying sporting teams to and fro.

That's us—Ansett Airlines of Australia, the sports travel specialists. If 15 or more of you fly together, we knock 10% off your air fares, we give you a special group baggage allowance, and in most

cases we tote your sporting equipment free of charge if it travels on the same flight with you. We can also make your hotel/motel reservations, and even help you find a venue if you're having a big get-together. Call us and get all the details from the people with the sports travel experience.



**ANSETT**  
AIRLINES OF AUSTRALIA  
The Sports Airline

**ILLAWARRA DISTRICT, 2-9-78** — DTL (25). Monthly Mugs Cup: K. Edwards. Dapto SB Ch: R. Duncan, K. Perkins, J. Maxwell; FM J. Ryan.

**ILLAWARRA DISTRICT, 17-9-78** — Fine (55). Ampol Shield: 1st Royal Aero - L. Trew, C. Davenport, A. Stanfield, G. Kidd, G. Frederickson 93-100. 20t Hcp Trophy: G. Frederickson 40-40, P. Gibbs 39-40, R. Parker 34-35; FM G. Kidd 30-31; BM K. Edwards 39-40. Verdon Bros. Shield: 1st Illawarra No. 1 J. Maxwell, W. Jones, R. Webb, F. Rapley, K. Perkins 142-150; 2nd Illawarra No. 2 F. Bradwell, K. Edwards, L. Scott, R. Duncan, P. Gibbs 142-150. Avon Double Barrel Ch: F. Bradwell 58-58, F. Rapley 57-58, M. Lyons 54-55; FM H. Koselski 20-21. High Gun Sweep: P. Gibbs 78-80.

Thanks to the visitors from Queanbeyan and Royal Aero who fielded teams in both Shields. Congratulations to the Royal Aero team who defeated Illawarra No. 2 in a shoot-off for the Ampol Shield.

**INVERELL R.S.M., 16-9-78** — Beautiful and sunny (30). 20t DB 16m: 20-20 John Lane (Inverell), Bud Sweeney (Guyra); 19-20 R. Potter (Texas), T. Manchee (Moree), P. Rafferty (Guyra), R. Hammond (Guyra), D. Reeves (Guyra). 20t PS Hcp: 57-60 P. Jensen (Inverell), C. McLane (Inverell), J. Redman (Inverell). 5pr DR: 10-10 Don Reeves, 9-10 Pat Rafferty, Cliff McLane.

Good to see Veteran Shooter Cliff McLane shooting so well with another local Kevin (Joe) Redman, winning the High Gun so convincingly. Another shooter gradually making his way to consistent possibles is John Lane. Welcome to shooters from New England, Guyra, Texas, Moree.

**JUNEE, 24-9-78** — Fine (35). 10t DB EO: 6 divide 10-10. 20t DB Trophy Hcp: T. Edwards (Downside) 28-28, J. Considine (Junee) 27-28, G. Seary (Junee) 26-28. 5t off 11m 5t off 25m: A. McKenzie, R. Fox 10-10, T. Barnwell, B. Hall 9-10. 10t Cont 16m: 8 divide 10-10. FM: R. Coleman (Ganmain); Ladies Trophy: L. Blake (Downside); High Gun: A. McKenzie (Downside) 49-50.

**YAKE CARGELLIGO, 3-9-78** — Showers then sunny (12). 20t Nthrn Riverina PS Ch: OA & 'A' D. Sullivan 58-60, 'B' R. Dawes 57-60, 'C' J. Rixon 55-60. 5pr DR 16m SS: S. Trembath 10-10, L. R. Brown 8-10, D. Sullivan, B. Minos, R. Dawes, R. Rixon 7-10. 10pr Black Swan DR Ch: OA & 'B' B. Minos 17-24, 'A' D. Sullivan 13-20, 'C' G. Richards 11-20. 20t \$4 Hcp SS: B. Minos, T. Dawson 20-20, D. Sullivan, J. Rixon 17-20. 10t \$2 SS 18m: L. R. Brown, D. Sullivan, R. Dawes, J. Rixon 10-10. Don Sullivan won the High Gun.

**LISMORE, 27-8-78** — Fine, windy (24). 10t SB Hcp "Mug": R. Turner. 10t DB Hcp "Trap": R. Boyes. 20t DB Ned Toney Shield 18m: Lismore No. 1 Team - J. Tainsh, R. Turner, J. Ferrett, D. Sloan, W. Durheim. 20t DB City of Lismore Ch 16m: R. Turner 'A' 42-43, R. Boyes 'B' & OA 20-20, C. Fuller 'C' 20-21.

Event 3 was shot between Lismore and Grafton.

**LISMORE, 24-9-78** — Cloudy and windy (18). 10t SB "Mug": W. Delandre 12-12. 10t DB Hcp "Tray": R. Turner 11-11. 20t DB 16m Lismore vs Teranora Shield: R. Turner, H. Sages, W. Delandre, J. Duyker, J. Ferrett. 20t SB Club Ch: D. Sloan 34-34 'A', J. Duyker 16-20 'B', R. Starr 16-21 'C'. 5pr DR 16m: R. Starr 10-10, K. Gibson, J. Tainsh, R. Turner 8-10.

**MARCONI, 3-9-78** — Fine (63). 15t DB Hcp CD: 9 possibles. Strn Dist PS Ch: 'A' & OA K. Edwards 72-72, V. Watson 66-69; 'B' W. Thompson 69-72, L. Crema 66-69; 'C' M. Holland 57-60, E. Warner 61-69. City of L'pool DB Ch: 'A' P. Santarossa 42-43, A. Alvaro 39-40; 'B' & OA L. Crema 43-43, J. Szabo 34-35; 'C' K. Voltz 22-23, N. Freeland 20-21. City of L'pool DR Ch: 'A' & OA M. Lyons 23-28, G. Fitzgerald 21-26; 'B' P. Babovic 19-32, R. Monserrat 18-22; 'C' J. Strong 17-20, N. Jones 14-20. High Gun: R. Monserrat 127-134.

On this day we had the pleasure to welcome back again a bus load of shooters and their families from Queanbeyan-Canberra Gun Club. The highlight of the day was the Inter-Club Competition for the highly coveted "Gusanda Cup" which on this occasion was won by Marconi. Congratulations to Ralph Monserrat on his first High Gun win from a field of very competitive shooters.

**MARCONI, 17-9-78** — Good (30). 15t DB Hcp CD: A. Piazza, E. Wood, J. Bosco shot possibles. City of P'matta DB Ch: 'A' K. Loy 25-25, M. Galli 37-38; 'B' & OA L. Crema 30-30, J. Szabo 29-30; 'C' A. Piazza 23-25, R. Dawson 22-25. Lucas Hgts DB Cont Ch: OA K. Loy 20-20, 'A' M. Galli 23-24, 'B' L. Crema 20-21, 'C' A. Piazza 19-20. 20t DB 16m CD: C. Grima shot possible with B. Naylor, M. Galli, S. Toson 19-20. 10pr DR CD: C. Grima, M. Galli 16-20, S. Toson 15-20.

**MENINDEE, 3-9-78** — Fine and sunny, light southerly wind (20). 10t EO CD: 5 possibles R. Zannette, J. Dini, J. Caskey, R. Holland, B. Gilby. 15t Hcp: 5 possibles B. Gilby (Broken Hill) 32-32, M. Ward (Broken Hill) 31-32, S. Barnes 26-27 (Pooncarie); FM R. Zanette (Broken Hill) 15-15. Menindee G.C. DD 1978 Ch: W. Ingledeed and R. Zanette (Broken Hill) 17-17 pr, 2nd S. Barnes and D. Smith (Pooncarie) 16-17 pr. 5pr DR: R. Pedergrana (Broken Hill) 15-16, R. Zanette (Broken Hill) 13-14, P. Loughlin (Broken Hill) 13-16; FM D. Forsyth (Menindee) 7-10. Novelty Event Sit down shoot 10t PS CD: M. Ward (Broken Hill) 30-30 and B. Gilby (Broken Hill) 30-30. Annie Oakley: R. Machul (Broken Hill).

A lucky break in weather to produce fine shooting conditions. Many possibles shot, followed by some pressure shooting in the shoot-offs. Another most enjoyable day.

**MORISSET HOSPITAL, 3-8-78** — Calm, cloudy (12). 10t EO 16m: A. Morgan, T. Turner, S. Smith, D. Norris, R. Haywood 10-10, A. Green, P. Turner 9-10. 15t PS 16m: B. Browne, A. Green 45-45, N. Jackson 41-45, T. Turner 40-45. 15t Cont 16m: A. Morgan, T. Turner, R. Haywood, N. Jackson 15-15. 20t Hcp DB: A. Morgan, S. Smith 20-20, L. Milligan, B. Browne, R. Haywood, P. Turner, N. Jackson 19-20.

**MORISSET HOSPITAL, 26-8-78** — Fine, south-west wind (16). 10t EO 16m: A. E. Morgan, D. Norris, B. 10-10, B. Browne, M. Boddy, S. Smith, A. Green, L. Wheeler, E. Hill 9-10. 20t DB 16m: G. Rommell 20-20, S. Smith 19-20, A. E. Morgan, F. Bolland 18-20. PS Hcp: B. Browne 45-45, A. Harvey, L. Wheeler



## NSW GUN CLUB

131 Booralie Road, Terrey Hills 2084.

(Turn off Mona Vale Rd  
at Terrey Hills Shopping Centre)

SAT. 11th NOV. 10 a.m.

SUN. 12th NOV. 10 a.m.

**4th ANNIVERSARY  
CHARITY SHOOT**

(see detailed advt. in this copy)

SAT. 25th NOV. 1 p.m.

**KURING-GAI CHASE P/S C'SHIP  
N.S.W. GUN CLUB OPEN  
D/R & D/D CHAMPIONSHIPS**

SUN. 26th NOV. 12 noon

**SOUTH PACIFIC OLYMPIC  
TRENCH C'SHIP 100 T**

SAT. 9th DEC. 1 p.m.

**OPEN CHRISTMAS  
HANDICAP SHOOT**

SAT. 16th DEC. 1 p.m.

**CHRISTMAS SHOOT  
MEMBERS ONLY**

Practice Shoot every Wednesday 1.30 p.m.

**NIGHT COMPETITION  
EVERY WEDNESDAY NIGHT.**

**FULLY LICENSED CLUB HOUSE  
CARTRIDGES & COMPONENTS  
AVAILABLE**

**PRESIDENT:**  
Charles Hlavaty.

**GUN CLUB CONTACT**  
(in residence):  
Guy Bedington.  
Phone (02) 450 1775.

44-45, M. Boddy 41-45. 20t SB Hcp: L. Milligan 17-20, L. Wheeler 18-20, B. Browne, A. Morgan, A. Harvey 16-20.

**MORISSET HOSPITAL, 10-9-78** — Fine and warm (44). 10t EO CD 16m: B. Browne, A. Morgan, R. Hancock, W. Weigold, I. Mills, K. Morgan, T. Turner, V. Phillips, D. Porteus 10-10. 15t DB 16m: I. Mills, R. Hayward, A. Green, D. Balsdon, F. Bollard, V. Phillips, N. Nugent, R. Crittenden 15-15. 20t DB 16m Morisset Hospital Ch: W. Weigold 20-20 OA winner; 'A' E. Hill, 'B' A. Morgan, 'C' K. Morgan. 20t DB Hcp: R. Hayward, C. Casey, T. Davies, B. Lansbury, D. Porteus 20-20.

The Morisset Hospital Gun Club was very pleased to welcome N.S.W.C.T.A. President Mr V. Phillips, who presented the Championship trophies to the winners, and a membership pennant to the club.

**NARRANDERA, 19-8-78** — (12). 10t SB off 18m: R. Fox. Riverina Zone SB Ch: L. McDonald, D. Fox, P. Morgan; FM G. Tabian.

Night — (25). Central Riverina DB Ch: L. McDonald, G. McDonald, P. Bowditch; FM G. Tabian; lady shooter Marie O'Dewahn. NSW Cont SB Ch: G. McDonald, B. Stockton, N. McDermott; FM P. Morgan; lady shooter Marie O'Dewahn.

**NARRANDERA, 20-8-78** — Overcast day (52). 10t PS off 18m: L. McDonald. Riverina Zone PS Ch: W. McDonald, K. Sim, B. Rooke; FM A. Fennessy; lady shooter Rosie Salkeld. N'dera & Dist SB Ch: D. Lucas, D. Fox, D. Menck; FM Lynette Blake; lady shooter Nola Charles. \$100 Hcp: D. Alexander, G. Craze, K. Langley, G. Guymer, T. Edwards, B. Wragg. Amoco Shield: Warrandera (No. 2), B. Press, J. Langley, G. Craze, K. Langley, R. Bushby 96-100. High Gun over 2 days and 1 night: Les McDonald — 20-150 tgt.

**NARRANDERA, 9-9-78** — Night (19). 10t DB: K. Collins and B. Press. 15t DB Trophy: K. Collins, A. Raadever, G. Salked; FM Sue Merriman; lady shooter Alice Walker; BM N. McDermott. 5pr DB: Allan Walker.

**NARRANDERA, 17-9-78** — Fine (31). 10t DB EO: A. Bound, K. Longmore, K. Woodbridge, L. Irvin, L. Bisa, K. Langley. 20t DB Trophy: L. Irvin 60-60, K. Langby 59-60, K. Woodbridge, K. Collins; FM M. O'Dowd; BM M. Stanmore; lady shooters Kathy Wardman, Joan Longmore; 11-13 High Gun K. Collins; High Gun OA K. Woodbridge. 20t SB: 19's only K. Woodbridge, K. Collins, L. Trim.

All the proceeds went to our Spastic Council entrants Miss Karen Cross — \$140 was raised for Karen.

**NEW ENGLAND, 17-9-78** — Fine and mild (39). 5t DB Hcp: C. Newby, J. MacTaggart, A. Kempton, R. Skinner, D. Futter, T. Varley, N. Champion, C. Varley 5-5. 10t SB Hcp: J. MacTaggart, J. Penrose, K. Sweeney, R. Sweeney, J. Ellis, R. Loy 10-10. 20t PS Hcp: J. MacTaggart 57-60, R. Sweeney 55-60, A. Kempton, C. Bloxsome 54-60. 10t Cont Hcp: I. Boyd-Law, J. Bower, D. Ellis, C. Anderson, D. Anderson 10-10.

Overall High Gun John MacTaggart 81-85; FM High Gun: Alan Kempton 77-85.

**N.S.W., 2-9-78** — Overcast, windy (24). 10t EO DB 16m: 7 possibles divided. Sydney Dist PS Ch: OA & 'B' C. Brown 60-60, 'A' F. Ward 57-60, 'C' L. Wheeler 59-60. Duffy's Forest Mixed Tgt Ch: OA & 'B' P. Zikman 22-25, 'A' J. Politi 31-35, 'C' L. Wheeler 30-35. 20t PS 16m Trophy: C. Hlavaty 60-60, P. Zikman 70-72, J. Politi 69-72. High Gun: J. Politi 144-150.

Congratulations to Cliff Brown on winning PS C'ship. It was his first win overall. The same applies to P. Zikman, 'B' Grader winning overall in Mixed Targets Trophy Event won by our President Charles Hlavaty, only possible score in that event. We welcomed visitors from Morisset Gun Club, who were scoring well and L. Wheeler lost 2 metres from his Handicap.

**N.S.W., 3-9-78** — Overcast (17). 50t Metro Skeet Ch: OA and 0-1m grade G. Bedington 48-50, 2-4m grade K. Biggs 47-50, 5-10m grade D. Cotton 49-58. 50t Skeet Trophy: R. Ward 102-108, A. Kavanagh 99-108, J. Watson 98-108.

Most enjoyable afternoon. Congratulations to Bob Ward, winning Trophy Event after shoot-off in which he killed 58 targets straight — also on the day his Handicap dropped from 06 to 01!

**N.S.W., 9-9-78** — Fine, mild (35). NSW G.C. Ch Day, members only. 10t EO PS 16m CD: 3 divided R. Wade, E. Kavanagh, C. Hawkins. NSW G.C. Ch 20t DB 16m: R. Northcott 27-27, A. Jericevich 26-27, C. Spence 30-30. 25t Skeet Hcp: 10 possibles, divided. 25t Olympic Trench Graded: 'A' E. Kavanagh 24-25, 'B' C. Grima 22-25, 'C' K. Biggs 20-25.

Congratulations to Rex Northcott for winning club C'ship — his name will go up on honour board of N.S.W. Gun Club Champions.

**N.S.W., 16-9-78** — Fine (48). NSW G.C. Ch 20t SB: 'A' & OA J. Fuller 28-28, 'B' R. Carr 21-22, 'C' C. Hlavaty 16-20. Winchester Shoot 30t DB 16m Graded: 'A' A. Alvaro, K. Loy; 'B' D. Duffy, C. Dorman; 'C' I. McLeay, R. Willoughby. 20t PS 16m Trophy Grouped: 11-15m C. Hlavaty 55-60, D. Duffy 53-60; 16-20m J. Guberina 59-60, E. Kavanagh 69-72; 21-25m A. Alvaro 59-60, H. Somers 61-63. High Gun: A. Alvaro 107-110.

Our thanks to Winchester Australia for their support by donating trophies for "Winchester Shoot" and High Gun Trophy. Congratulations to J. Fuller Jnr for excellent shooting in SB C'ship, and Tony Alvaro for OA shooting and winning High Gun. Five shooters lost 1 metre of their handicap.

**N.S.W., 17-9-78** — Fine, mild (24). 100t Strn Zone Olympic Trench Ch: 'A' & OA T. Budd 93-100, 'B' G. Bedington 86-100, 'C' G. Hitchin 71-100.

Very pleasant shooting day. Terry Budd won OA and 'A' grade by one point from Roger Walker. George Hitchin did very well in his 'C' grade.

**ORANGE GUN & FIELD, 27-8-78** — Fine and sunny (25). 10t DB EO Hcp: 2 possibles Joe Angus, John Curran. 20t Club DB Ch: John Curran, Joe Angus; FM Howard Beadle. 40t DB Hcp: John Curran 38, Joe Angus 37.

John Curran was the most consistent shooter of the day with 76 breaks straight. A number of new shooters turned up to try their skill during the afternoon. The day concluded with a round or two or "off the box" with Max Laughton collecting the final proceeds.

# Upper Hunter Gun Club

Location 1.5 km from Scone on the Gundy Road  
Open Shoot

## SATURDAY 18th NOVEMBER

1 p.m. start

Event 1	10 T DB EYE OPENER	Nom \$2.50
Event 2	20 T LAKE GLENBAWN DB CHAMPIONSHIP 50c Opt Sweep each 10	Nom \$6.00
Event 3	30 T NTHRN ZONE W/U CH. 50c Opt Sweep each 15	Nom \$7.00
Event 4	CLUTHA DEVELOPMENT TROPHY HANDICAP ---- BBQ TEA ----	Nom \$5.00
Event 5	10 T DB EYE OPENER	Nom \$2.00
Event 6	30 T NSW NIGHT P/S CONT CHAMPIONSHIP 50c Opt Sweep each 15	Nom \$8.00

## SUNDAY 19th NOVEMBER

10 a.m. start

Event 1	10 T DB EYE OPENER	Nom \$2.50
Event 2	20 T UPPER HUNTER DB CONT. C'SHIP 50c Opt Sweep each 10	Nom \$6.00
Event 3	20 T UPPER HUNTER SB CONT. C'SHIP 50c Opt Sweep each 10	Nom \$6.00
Event 4	20 T HANDICAP GUN TROPHY	Nom \$15.00

OTHER EVENTS TIME PERMITTING

Meals, Refreshments and Cartridges available.  
Camping on Grounds available.

President:  
Eddie Milham,  
Simpson Street,  
Quirindi. Ph: 628.

Secretary:  
Ron Wakem,  
8 Little Street,  
Scone. Ph: (065) 45 1798.

**PARKES, 12 & 13-8-78** — Cold and rain (78). 10t DB 18m: 10's K. Rogan, D. Menck, D. Osborne, K. Longmore, A. Turner Jnr., R. Ellison, L. Morris, J. Scott, C. Cunningham, K. Thompson, J. Manns, R. Piotrowskie, N. Williamson, A. Povey, S. Balogh, B. Smith. Western Zone Team Elim 20t DB 18m: 20's J. W. Smith, M. Williams, R. Lehman, L. Hearne, B. Smith. 20t SB 18m: 20's K. Thompson, 19's R. Ellison, V. Bauert, V. Burgess, J. Manns Jnr. 20t PS 18m: 59-60 J. Scott, 58-60 V. Burgess, J. Curran, N. Williamson; 1st V. Burgess 95-110, 2nd K. Thompson 128-140, 3rd J. Scott 127-140. N.S.W. Night DR Ch: OA & 'B' J. Hunter 26-30, 'A' 24-30, 'C' R. Carr 18-30. 10t DB 16m: 10's R. Leahman, R. Jenkins, D. Osborne, L. Morris, J. Scott, D. Menck, R. Atkinson, K. Longmore, Mrs J. Longmore, J. Blain, B. Smith, S. Balogh, M. Lyons, N. Williamson, P. Lyons, R. Piotrowskie, J. Marshall, R. Carr, A. M. Burgess, J. Watts. 30t Eley Waratah State Classic: 30's K. Longmore, S. Balogh, N. Williamson, L. Arnold, D. Osborne, R. Atkinson, J. Hunter, A. Turner Jnr; 1st J. Hunter 68-68, 2nd L. Arnold 67-68, 3rd S. Balogh 62-68; Best Lady J. Longmore 33-34; Best Junior A. Turner 30-30. J. Hunters break 76-77. 20t DR \$100 Hcp: 20's R. Leahman, A. Turner, R. Atkinson, J. Curran, N. Williamson, A. P. Bourke, J. Cassell, M. Holland. 20t DB CD Graded 16m: 'A' 20's L. Arnold, V. Burgess, G. Weaver; 'B' 20's R. Leahman, K. Rogan, 19's J. Hunter, B. Duncan; 'C' 20's A. Turner Snr., A. Atkinson, 19's J. Marshall.

Very wet miserable conditions for Saturday but fined up for Sunday.

**PARKES, 12-9-78** — Dull and breezy (29). 10t DB Mini 16m: 10's R. Piotrowskie, T. Golding, 9's I. Hall, B. Minos, E. Miles. Parkes G.C. DB Mini Ch: 17's D. Wilson, J. W. Smith, L. Arnold, J. Scott, B. Minos. 1st J. Scott 21-24, 2nd D. Wilson 23-28, 3rd J. W. Smith 22-28; FM I. Hall 15-20. Tyack Shield 20t \$100 Ch: 1st Illawarra, 2nd Parkes; 20's B. Minos, 19's I. Hall, R. Daws, D. Coleman, K. McCumstie. 10t Novelty: 9's D. Coleman, 8's B. Minos, 7-7 D. Rogan, T. Golding. 10t DB SS Hcp: 10's G. Jackson, K. McCumstie, B. Gault.

High Gun won by B. Minos 4 down and also gained a metre going from 16 to 17 metres.

**PORT MACQUARIE, 3-9-78** — Fine gusty north-east wind (7). 10t DB CD off Hcp: G. Wyatt, K. E. McWhirter, K. McLeod. 10t PS CD off Hcp: B. Herbert, C. Cross, K. E. McWhirter. 5pr DR CD off 16m: C. Cross, K. E. McWhirter, G. Wyatt. 10t DB CD off Hcp: C. Cross, K. E. McWhirter, G. Wyatt. 10t SB CD off Hcp: C. Cross, K. G. McWhirter, B. Herbert. 10t Quail Novelty Event CD: K. E. McWhirter, C. Cross, B. Herbert.

A nice day, though attendance was light possibly due to being Fathers Day. Hope to see more shooters next time.

**RANKINS SPRINGS, 17-9-78** — Fine, windy (28). 10t EO 16m: 13 shooters shot 10-10 C. Strike, G. Castellaro, T. Merriman, P. McWilliam, N. McDermott, L. Bonaventura, L. Odewahn, E. Wardman, E. Heppernan, D. Melia, J. Irvine, D. Hopper. 20t Conapaira Range DB Ch 16m: N. McDermott 68-68, D. Sullivan 67-68, L. Odewahn 45-46. 5t EO PS 18m: T.

Merriman, R. Stockton, D. Sullivan, T. Dawson, L. Bonaventura, D. Melia, J. Harman, D. Hopper, N. Hampel 5-5. 20t Riverina Zone PS Ch 18m: D. Hopper 59-60, T. Merriman 73-75, D. Lucas 72-75. 20t \$100 Hcp: I. Bonaventura, S. Merriman, L. Brissenden, J. Irvine, J. Jennings 20-20.

High Gun was won by Dennis Hopper with 3 points down.

**ROYAL AERO, 27-8-78** — Fine (60). County of Cumberland SB Ch: 'A' & OA M. Galli 20-20, 'B' B. Casey 20-21, 'C' P. Abela 19-20. Pitts Special DB Ch: 'A' & OA M. Galli 67-67, 'B' W. Rogers 21-22, 'C' O. Hall 30-31. Bangstown DR Ch: 'A' & OA A. Alvaro 20-20, 'B' W. Rogers 17-20, 'C' P. Abela 15-20. High Gun: M. Galli 58-60.

**ROYAL AERO, 10-9-78** — Fine (71). Aztec 100: 'A' & OA W. Jones 100-100, M. Galli 112-113, T. Ansell 111-113; 'B' P. Muscat 98-100, T. Price 97-100, J. Nascimben 96-100; 'C' P. Abela 95-100, J. Strong 108-113, O. Hall 107-113.

**ROYAL AERO, 24-9-78** — Fine (63). Commanche PS Ch: 'A' & OA A. Romanello 63-63, 'B' G. Fredericks 58-60, 'C' P. Abela 56-56. Trophy DB Ch: 'A' C. Farugia, 'B' T. Price, 'C' P. Abela. County of Cumberland DR Ch: 'A' G. Fitzgerald 23-24, 'B' P. Gibbs 18-20, 'C' P. Abela 18-20. High Gun: G. Fitzgerald 58-60.

**SYDNEY, 26-8-78** — Fine and mild (29). Partnerships Day. 15t DB off Hcp: To be shot as a team of two, the result of each team member to be added together to determine first, second and third place. 15t DB off 16m, 10pr DR off 16m: 1st team - M. Galli and W. Every 93-100, 2nd team - B. McGill and J. Miatt 88-100; 3rd team - R. Alvaro and A. Alvaro 88-100. A shoot-off decided the 2nd and 3rd placegetters.

**TAMWORTH GUN CLUB**  
**3RD DECEMBER — 10 A.M.**  
**Christmas Shoot**

Event 1 — 10 TGT EYE OPENER 16 m

Event 2 — **EASTERN STATES GRAND OPEN**  
**50 TGT POINTS SCORE C'SHIP**  
 Graded. Badge & Sash Overall.

Event 3 — 20 TGT CASH HANDICAP  
 HIGH GUN Points to count — BBQ LUNCH

Secretary: Mick O'Connor. Treasurer: Ray Melville. President: Col Burt.

**PARKES**  
**GUN CLUB**  
**SATURDAY 11th NOVEMBER**  
 1.30 p.m. start

Event 1 10 TGT DB S/S 16 m Nom \$2.00

Event 2 "GOLDEN GRAIN"  
 DB C'SHIP 20 T DB 16m Nom \$6.00  
 O/S 50c each 10, 50c O/A.  
 1st Badge & Trophy; 2nd, 3rd, F.M. 11-13m.

Event 3 20 TGT P.S. A. G. ROWLEY  
 "ROSEBOWL"  
 5 Man team. Trophy for each member of winning team  
 in conjunction  
**D.B. TROPHY EVENT**  
 1st, 2nd, 3rd. 50c each 10, 50c O/A  
**SPECIAL TROPHY FOR 11 METRE**  
**SHOOTERS ONLY**  
 Donated by E. Miles.

EXTRA EVENTS HIGH GUN  
 TIME PERMITTING BADGE 1 2 3  
 Cartridges, Refreshments, Afternoon Tea.

Pres: J. Watts. Sec.: D. Rogan.  
 Phone 62 2396. P.O. Box 514, Parkes 2870.  
 Phone: 62 3470.

**Yamba Gun Club**  
 (Affiliated A.C.T.A.)  
 Situated on Palmers Island  
 off MacLean-Yamba Road.

**Saturday 18th November**  
 commencing at 2 p.m.

**SWEEPSTAKES EVENTS**  
 Saturday Night  
**N.S.W. STATE NIGHT**  
**SKET CHAMPIONSHIP**

**Sunday 19th November**  
 commencing at 9.30 a.m.

Winchester Perpetual  
 Skeet Teams Shoot  
 Teams of 5 shooters — 25 targets  
 in conjunction with the Big River  
 District Skeet Championship

**HIGH GUN OVER PROGRAM**  
**DOWN THE LINE EVENTS**  
**ON SUNDAY AFTERNOON**  
**Eats and Refreshments on the Ground.**

President: A. N. Rowe, Secretary: S. Humphreys,  
 P.O. Box 93, 147 Powel Street,  
 YAMBA. 2464. GRAFTON. 2460.  
 Phone: 46 2146. Phone: 42 4602.

A novelty day, but nevertheless most shooters seemed to enjoy themselves. Mario Galli completed a great performance by scoring 20-20 in the Double Rise event. A great effort Mario.

**SYDNEY, 9-9-78** — Fine and mild (30). 10t EO off 16m: 11 shooters shared the Comp. CD. Sydney G.C. SB Ch 20t off 16m: A. Romanello 20-20, M. Galli 30-31, J. Politi 29-31; FM J. Dimeglio 11-20. Eckersley Dist DD Ch 20pr DB off 20m: G. Frederickson and G. Kidd 20-20, M. Galli and A. Romanello 24-25.

A very pleasant day. Nice to see a team of comparatively new shooters take out the Deauville Doubles event in such fine form.

**TAMWORTH, 17-9-78** — Perfect, fine and bright. 25t Hcp Event: possibles J. Harkin, R. Whitten, G. Walters, R. Melville, A. Coyle, B. Baxter, B. Palmer, B. Maher, J. Cassin, G. Tomkinson and C. Swanborough. 50t Tamworth & Dist Skeet Ch: OA R. Melville, 0-1 C. Burt, 2-4 J. Cassin, 5-10 J. Harkin. High Gun: Ray Melville.

**TERRANORA LAKES, 13-8-78** — Extremely windy (28). 10t SB "Rose Sags" Cup Nov. Hcp: S. Hinze, L. Cobden 8-10. 15t DB 16m SS: H. Sags, R. Turner, J. Tainsh 14-15. 30t DB Terranora Lakes Ch 16m: 'A' D. Sloane O/A, 'B' J. Ferrett, 'C' B. Witt. 20t DB Cont 16m SS: M. Westbury, H. Sags, W. Markwell, A. Witt, B. Delandre 18-20. FM A. Witt; High Gun: D. Sloane.

**TERRANORA LAKES, 10-9-78** — Fine (25). 10t SB Hcp Rose Sags Cup: M. Otto, M. Hinze 9-10. 15t DB Hcp SS: R. Garrett, J. Duyker 15-15, 4 tied with 14-15. 30t SB 16m Terranora Lakes Club Ch: 'A' R. Pennisi 26-30, 'B' J. Duyker 28-30, 'C' J. Heiman 22-30; OA J. Duyker. 15t DB Cont 16m SS: J. Ferrett, R. Pennisi, R. Turner 14-14. High Gun: J. Duyker; FM R. Garrett.

**TYAGARAH, 3-9-78** — Fine. 5t DB 16m: J. Duyer, R. Weedon, D. Sloan all 5-5. 25t DB Ch: OA D. Sloan 25-25, 'B' J. Duyker 25-29, 'C' S. Hinze 28-32; FM M. Hinze 17-25. 10t SB Mug Hcp: P. Flack 9-10. 20t DB 16m Cont. Sweeps: J. Duyker 18-20, C. Nelson 17-20, D. Sloan 17-20.

**WARREN, 9-9-78** — Fine (22). 20t DB 16m: R. Gale 20-20, K. Elias, D. Hunt 19-20. 10t PS Hcp: B. Murphy 31-33, B. Mayger 28-30, Hans 26-30. 10pr DR Ch: D. Hunt 17-20, B. Mayger 16-20, B. Murphy, K. Elias, R. Kinsey 15-20. 10pr DD: D. Hunt and B. Murphy 12-15, G. Hunt and D. McMillan 12-15, D. Bridgen and D. McCalman 11-15.

**WEST WYALONG, 16-9-78** — Fine (27). 10t Hcp DB CD: G. Bolte, R. Rixon, K. Kelly, B. Crossman, R. Heffer 10-10. 20t DB Hcp Trophy: G. Duncan 34-34, B. Crossman 33-34, F. Ashton 31-32. 15t DB CD 18m: V. Kaims, D. Hopper 15-15, F. Ashton, B. Moncrieff, D. Menck, B. Duncan 14-15. 15t SB CD 18m: V. Kaims 15-15, R. Dawes, B. Duncan, L. Anderson 14-15.

**WYONG, 26-8-78** — Fine (23). 15t DB Hcp: B. Martin, N. Spencer 14-15. 30t PS Hcp Trophy: 11-14m trophy P. Turner 85-90, 15-18 m trophy P. Zikman 122-129, 19-25m trophy L. Kent 84-90. 20t CD off 16m: 'A' E. Hill 19-20, 'B' R. Clifton 22-23, 'C' J. Singleton 26-28. **WYONG, 8-9-78** — Fine, cloudy (15). EO DR 10pr off 16m: R. Britton, S. Smith 16-20. Central Coast DD Ch off 20m 20pr: N. Jackson, K. Thompson 38-40; 2nd P. Zikman and K. Moxey 37-40. 20t DB Hcp: L. Littlefield, A. Green 30-30.

**YAMBA, 16-9-78** — Fine, night tower (15). 10t DB SS Tower: S. Spears, S. Humphreys, R. Welsh, R. Boyes, B. Field, G. Yates 9-10. Big River Dist Night DB Tower Ch: B. Field 20-20, S. Humphreys 19-20, R. Palmer 28-30. Nthrn Zone Night Tower DB Ch: R. Palmer 23-24, R. Burton 22-24, L. Cooper 31-33.

**YAMBA, 16-9-78** — Fine (18). 10t DB SS: Mrs H. Burton, S. Spears, R. Burton, W. Yates 10-10. 10t PS SB: S. Spears 30-30, T. Watts 29-30, Mrs H. Burton 28-30. 15t PS Trophy: R. Burton, S. Spears 42-45, L. Cooper, A. Rowe, G. Rardon 40-45; shoot-off R. Burton 51-54, S. Spears 48-54, G. Fardon 46-51. 20t DB Cash Hcp: C. Fuller, D. Hancock, L. Cooper 19-20.

**YAMBA, 17-9-78** — Fine (21). 5pr DR SS: B. Wenban 10-10, R. Burton, J. Tainsh, D. Sloan, G. Bennett, T. Spears, M. Short 7-10. Big River Dist DR Ch: OA & 'A' D. Sloan 21-24, 'B' L. Cooper 15-20, 'C' T. Spears 14-20. Big River Dist DD Ch: R. Burton & Mrs H. Burton 19-20, B. Weuban and A. Rowe 31-33. 20t DB Cash Hcp: G. Yates 20-20, J. Tainsh, L. Cooper, P. Flack 19-20. High Gun: R. Burton 135-155.

It was pleasing to welcome Dick and Hazel Burton from Geraldton, W.A., to our shoot. Dick was in fine form winning the trophy event, 2nd in the Night Northern Zone Tower Championship, the Overall High Gun and teamed with Hazel to take the DD Championship outright. At the conclusion of the program Dick gave Skeet tuition to a number of shooters which was greatly appreciated. Shooters visited from Geraldton, W.A., Taree-Wingham, Port Macquarie, Coffs Harbour, Grafton, Lismore and Tyagarah.

### Collector's Column (Cont'd from page 23)

The trigger guard bow engraved with a figure of a sportsman loading up his gun with a spaniel at his feet. The stock is of excellent figure, silver butt plate with fancy engraved side plates coming down the stock sides, all most tastefully and beautifully carried out — complete in its decorated mahogany velvet lined vase, partitioned for a whole wardrobe of apparatus and accessories, including a dog whip, the accessories being covered with tortoise-shell. Its cleaning rod of brass joints had its own leather case. The initial cost of the outfit being 84 Pounds 10 Shillings.

Both of the arms described have an overwhelming and dazzling beauty reflecting an age of elegance and unhurriedness.

The Collection contained a most beautiful Flintlock rifle with a heart-shaped bore. It and others will be described in Part 2. ○

## GRIFFITH GUN CLUB will conduct its ANNUAL NEW YEAR PROGRAM

on December 30th & 31st, 1978  
and  
January 1st, 1979

Secretary: H. Hillery,  
6 Lawson Crescent,  
Griffith, N.S.W. 2680

## Winchester Tournament — Tamworth Gun Club

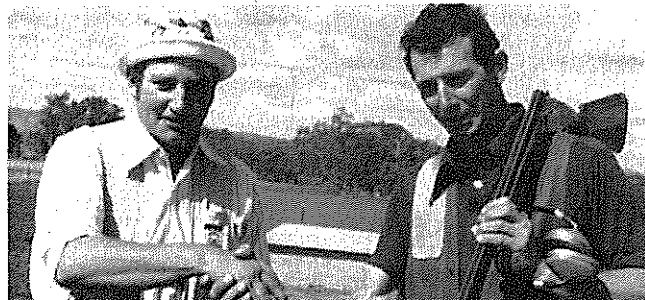

● Grahame Wilson (left) and Bill Davis (right) only two possibles wish each other luck before commencing shoot-off.



● Geoff Salmon (left) with Col Burt (President Tamworth Gun Club) congratulating Dianne Davis winner Ladies Section of Tamworth Winchester Tournament.



● Geoff Salmon (left) and Col Burt (President T.G.C.) with Andrew Elks, winner junior section Winchester Tournament.

## September Open Shoot Cowra Gun Club

A challenging program of events brought 85 shooters to Cowra at the weekend for the annual September Open Shoot. Visitors attended from Bombala, Cowra, Berridale, Dubbo, West Wyalong, Bathurst, Orange, Tumut, Parkes, Grenfell, Boorowa, Queanbeyan-Canberra, Goulburn, Portland, Blayney, Narranderra, Leeton and Sydney.

The weekends program consisted of three championships, the Lachlan Valley Double Barrel, the Central Tablelands Double Barrel night, and the Lachlan Valley Single Barrel Championships. The two major events on Sunday were the Eley Perpetual Trophy and the Eley Gold Cup.

After a welcome sweepstake in which 15 shooters shot the possible, the Lachlan Valley Double Barrel Championship attracted 82 shooters. Twelve shooters qualified for the shoot-off with 20-20.

The lengthy shoot off of 97 targets which followed, determined the outright winner, W. Jones, and winner of the 'A' grade, R. Northcott, and 'C' grade S. Beasley (Orange). 'B' grade winner was determined after a shoot-off of the seven 19-20's. After an 18 target shoot off, A. Ambs of Illawarra was 1st, with O. Feilen (Bombala) second. Second in the 'A' and 'C' Grades were L. Hearne (Goulburn) and J. Williams (Berridale) respectively.

Another sweepstake event followed, with 11 possibles, 15-15.

After a delicious tea served by the Cowra Club ladies, the night program commenced with the Central Tablelands Double Barrel Championship with 65 shooters nominating. Only two shooters shot the possible 20-20, J. Hayes 'B' grade, and L. Arnold 'A' grade. These two shot off, and J. Hayes was outright winner 26-26, and L. Arnold (Bathurst) was then the winner of the 'A' grade 25-26. Second in the 'A' grade was C. Hawkins 21-22 after a shoot off between four 19-20's, L. Hearne, P. Bortolin, C. Hawkins and R. Piotrowski.

Three 'B' grade shooters with 19-20 in the event, L. Chodat, A. Ambs and N. Napier shot off to determine 1st and 2nd places in the 'B' grade. L. Chodat (Illawarra) was 1st with 42-43 and N. Napier 2nd, 41-43. 'C' grade was won by N. Dwight (Cowra) with 25-27 after a shoot off with T. Tindal 24-27.

Sunday brought cold wet weather conditions and 89 shooters nominating for the days events, first of which was a 15 targets sweepstake, 17 shooters attaining the possible 15-15. Seven shooters nominated for the second event, the Lachlan Valley Single Barrel Championship.

Once again only three shooters shot the possible 20-20, all of whom were 'A' grade. These three shot off only two targets and A. Hayes was the outright winner 22-22, W. Jones was 1st in 'A' grade 21-22 and K. Sim 2nd in 'A' grade with 20-21.

Two 'B' grade 19-20's shot off five targets to establish A. Ambs 24-25 the winner with D. McKenzie 2nd in 'B' grade with 23-25.

Two 'C' grades with 19-20 shot off, and T. Tindal was 1st with 27-28 and K. McCumsite 2nd, 26-28.

The two following events were both teams events. The first was the Eley Perpetual Trophy which was brought back to Cowra for competition by the Illawarra Gun Club who have won it during the past year in competition at another Club. Fourteen teams nominated, four local Cowra teams, Orange, Berridale, Marconi, 3 Illawarra, Leeton, 2 Hawkesbury and West Wyalong. Outright winners were Illawarra No. 1, with 93-100. Team members were J. Maxwell, W. Jones, F. Rapley, R. Northcott, and R. Hayes. Equal in 2nd place were Cowra No. 1, Hawkesbury Blue and Leeton with 92-100.

Fourth event on Sunday and final event for the weekend was the Eley Gold Cup. The rules and conditions regarding the Cup have been altered in the last year, from an individual event, to a teams event, shot off shooters handicap. It is competed for annually at Cowra in September and the winning team takes it to their Club for competition during the ensuing year.

Fifteen teams nominated, 5 Cowra, 1 Marconi, 2 Hawkesbury, 1 Orange, 1 Berridale, 3 Illawarra, 1 West Wyalong, and 1 Leeton. Hawkesbury Blue were the outright winners with 95-100. Team members were J. Hayes, E. Patterson, A. Hayes, R. Hunt and R. Clarkes. Second place went to Orange team, K. Ross, S. Beasley, B. Beasley, G. Nesbitt and W. Warren with 93-100. Third was the Cowra No. 3 team, P. Mould, S. Gittoes, B. Frost, R. Bright and G. Marshall.

An Intermediate High Gun and Open High Gun were conducted over the whole program. These were competed for keenly with both section results being unknown until the end of the program.

## Finley Gun Club helps celebrate Town's Centenary.



• Placegetters in the Finley Centenary DIB Championship. Left to right: Kevin O'Brien (FM), 2nd Russell Newby, 1st Vin Ryan, 3rd Jon Whittakers.



• Len Baker President Finley Gun Club 1945-1952.

## Downside wins Boomerang Shield.



• Team members — left to right: Bob Blake, Stephen Wilson, Jim Parr, Barry Hall and Wal Scott with the Boomerang Shield won at Finley with a score of 98-100. The Boomerang Shield will be competed for again at Downside International Gun Club on November 25th. (Photo by courtesy of Daily Advertiser, Wagga).

Intermediate High Gun was won by J. Williams (Berridale) from N. Dwight (Cowra) after the two shooters were equal in points until the last event.

Open High Gun result was determined after a shoot off between C. Hawkins and J. Hayes, who were on equal points at the end of the program. J. Hayes proved to be the winner after only a short shoot off of 16 targets, his final score being 137-151.

The weekends events culminated in the trophies being presented by Mr Len Bird, who has retired as President of the Cowra Club after 20 years in office. Mr Noel Dwight was stepped into the chair for the remainder of the year. ○

# ★ New South Wales Trap Carnival — West Wyalong



● 1978 N.S.W. Ladies Trap Team — L. to R.: Dianne Davis, Loraine Jenkins, Joan Longmore, L. Burgess, Angela Noll.

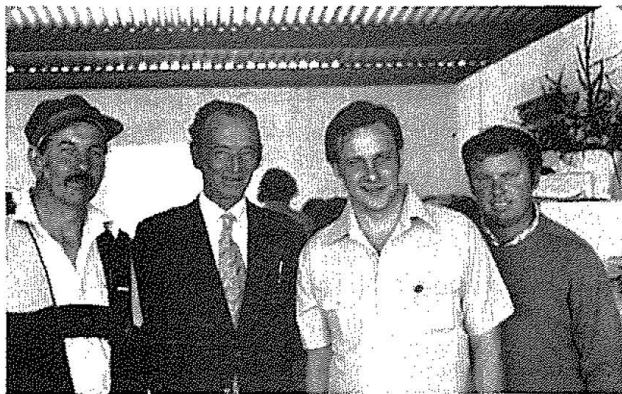

● Official guests at Opening of NSW Trap Carnival — L. to R.: Brian Moncrieff (WWGC President), Cr. Norm Pearce (President, Bland Shire Council), Mr Stephen Lusher (Federal Member for Hume), Graeme Duncan (Secretary WWGC).



● Vince Phillips presenting Ern Hawkins with a gift from the N.S.W. Association. (Photos by Len Anderson).



● 1978 NSW TRAP TEAM (left to right) — Kim Bucholtz, Herb Williamson, Ern Hawkins, Brian Minds, Beyan Brown, Ron Sky, Doug Lucas. Front row, left to right: Laurie Cooper, John Manns, Pud Burgess, Ray Melville, M. Galli, K. Thompson, W. Charlton, Glen Castellaro.





# QUEENSLAND

**BLACKALL, 17-9-78** — Fine and warm. (20). 5t EO: I. Murray, B. Harvey, R. Richardson, J. Harlow, L. Russell, P. Molle, Shirley Harlow, K. Harlow, J. Webber, Harlow 5-5. 15t DB Ladies Cup: L. Russell, P. Molle, B. Harvey, H. Jarvis 15-15. Ladies Cup won by Sharyn Harlow 11-15. 10t DB Pts off 16m: B. Harvey 30-30, K. Harlow, H. Jarvis 29-30. 15t SB Monthly Cup: K. Harlow 15-15. 7 pr DR: I. Webber 12-14, J. Wilks, P. Molle 11-14. 6 pr DD: K. Harlow, I. Murray 10-10.

**BRISBANE, 3-9-78. (30)** — Windy (30) Warana Trench Ch 50t: P. Freeleagus (Bris) 47-50, J. Dimauro (Bris) 42-50, B. Angel (Bris) 38-50. Sth East Qld Tr. Ch 50t: P. Freeleagus (Bris) 48-50, J. Farrow (Ipswich) 38-50, G. Udovichic (Bris) 34-50. Qld team H. Gun: P. Freeleagus 70-75. OA H Gun: P. Freeleagus 95-100.

Congratulations go to the following shooters who shot their way into the Qld Trench team: P. Freeleagus (Bris), A. Kenna (T'ville), J. Porter (Bris), T. Commerford (T'ville), D. Smith (Bris), and J. Dimauro (Bris).

**BRISBANE, 17-9-78** — Warm 24 deg. (39). 25t Hcp SS Stakes: 5 shooters shared. H.J. Potts, K. Reedman, B. Witt, C. Wheatley, G.J. Whimclop. 25t Gr trophy: 0-2 P. Freeleagus 25-25, 3-5 L. Harden 24-25, 6-10 G. Whincop 22-25. Warana Skeet Ch: 0-2 P. Freeleagus 25-25, 3-5 A. Witt 26-29, 6-10 P. Reedman 22-25. 25t Hcp SS Stakes: 'Doc' Middleton, H.J. Potts, A. Witt. H Gun: off the gun P. Freeleagus 99-100. H Gun hcp score B. Witt.

**BRISBANE, 20-9-78** — Cool (night shoot) 13 deg (33). Warana Pts Ch 20t 16m: OA M. Gough (Bris) 60-60, B. Nelis (Bris) 53-60, G. Goode (Bris) 59-60, A. Witt (Bris) 57-60. Warana SB Ch 20t 16m: OA M. Gough (Bris) 21-22, R. Lowry (Ipswich) 20-22, R. Maroske (Toogoolawah 18-20, A. Witt (Bris) 20-23. 15t DB ss 16m: P. Freeleagus (Bris), M. Gough (Bris) 15-15, B. Smith (Bris) 13-15, A. Witt (Bris) 15-15.

Consistent Brisbane shooter Martin Gough was once again in fine form to take out both of our annual Warana Night Championships. Well done, Martin.

**BRISBANE, 24-9-78** — Warm (Warana Shoot) (70). Bauman's Cup 20t DB Hcp: R. Pennisi (Bris) 22-22, A. Sammut (Bris) 21-22, P. Newcomb (Bris) 20-21. Best 11-14m: I. Scrymgeour (Bris) 37-39. Warana SB Ch 20t 16m: OA D. Smith (Bris) 20-20, B. Nelis (Bris) 19-20, R. Chapman (Ipswich) 22-23, H. Puschmann (Bris) 18-20. Warana DB Ch 20t 16m: OA P. Freeleagus (Bris) 27-27, M. Gough (Bris) 26-27, B. Smith (Bris) 22-23, Miss Ailsa Ramsay (Weipa) 21-22. 20t DB Pts 16m: 11-15m: S. Valastro 51-60, M. Puschmann 51-60. 16-20m: L. Shanco 58-60, K. Walker 58-60. 21-25m: W. Stevens 60-60, P. Freeleagus 59-60. H Gun: Doug Smith 79-80.

This was our annual Warana Shoot and once again we had Miss All Nations opening our shoot and firing the first shot. Congrats Doug on winning the H Gun with 78-80. Metres were gained by Mark Puschmann, Phil Newcomb and Ian Scrymgeour.

**BURDEKIN, 13-8-78.** — Good. (59). Presidents Trophy 15t DB: Tom Comerford Jnr (Tvl) 15-15, Ray Falco (Burd) 15-15, Cec Haller (Burd) 15-15. Patrons Trophy 20t SB: Frank Patane (Burd) 19-20, Tom Comerford Jnr (Tvl) 19-20, Wyn Goodrich (Tvl) 18-20. Quartermaine Trophy 10 pr DR: Doug Killick (CT) 18-20, Ray Falco (Burd) 17-20, Gitto Milani (Burd) 17-20. Burdekin Mixed Targets: Doug Killick (CT) 24-25, Arthur Kenna (Tvl) 23-25, Steve Schonenberg (Burd) 23-25. Ladies Day 10t SB for non-Assoc lady member: Mrs D. Killick (CT) 9-10, Mrs C. Nicolaidis (Burd) 7-10, V. Johansen (Tvl) 7-10. Winner of the Ashworth Shield: D. Killick (CT).

**CENTRAL BURNETT, 16-9-78.** — Perfect (39). 15t 7DB Cont 8 DB KILLS off 16m: Shared by J. Collins, N. Cayley, N. Willson, R. Rehbein. Gold Cob Cup 30t DB KILLS off 16m: M. Zipf (Mundubbera), A. Williams (Mundubbera), R. Rehbein (B'berg). 20t SB off 16m: A Grade, A. Williams (Mundubbera), B Grade, R. Duffy (Bundaberg), C grade: N. Cayley (Bundaberg). 20t DB KILLS off Hcp Night Event: B. Taylor (Mundubbera), R. Rehbein (Bundaberg), K. Zipf (Mundubbera). H Gun: K. Ziph. Best 11m shooter: J. Green.

This shoot was the Gold Cob shoot which was sponsored by Gold Cob P/L. There were shooters from Bundaberg, Kingaroy and Gladstone as well as Central Burnett members. During the day a team shoot between Bundaberg and Central Burnett was held with Central Burnett coming out the winners. A BBQ was held with one night event to follow. Congratulations to all the winners.

**CHARTERS TOWERS, 3-9-78.** — Cloudy, raining. (33). 10t DB Hcp: Possibles were G. Sharp, M. Risdale. 10t DB Tower: Possibles, D. Killick, M. Bell, W. Eggerstead, G. Sharp, W. Stevenson, A. Hilder, P. Bell, K. Deneen. 5t SB 11m event: N. Giddy, G. Hurst, K. Burgess. 20t DB Hcp: M. Risdale, F. Ford, G. Bell, L. Carty, K. Deneen. 18 Pr Deaville D BL Sel partners: G. Bell & G. Sharp, M. Risdale & L. Chisnel. Novelty Prog Shoot off: B. Morgan, M. Bell, J. Dobbins.

**DALBY, 27-8-78.** — Cloudy, slight wind (20). 10t SB Pts 16m: E. Hass, M. Hass. 20t DB Hcp: D. Wells, E. Hass. 20t DB Cont 16m: K. Mott, E. Hass. H Gun: E. Hass. Ex EV 11-25 25-11: M. Hass, E. Hass, B. Beckman.

A most enjoyable time was had by all present.

**DYSART, 27-8-78.** — Overcast but fine (30). 10t DB Pts Off Hcp: J. Hume, L. Powell shared 1st 30-30, R. Wood, D. Hambridge, G. Rayfield, R. Scharf all shot 29-30. 25t Mix Chp off 16m: J. Hume 22-25, C. Ennis 21-25, D. Casagrande 20-25. A grade, C. Ennis. B grade, D. Casagrande. C grade, J. Hume.

# BLACKALL GUN CLUB

## Annual Trophy Shoot

### SATURDAY 18th NOVEMBER

9.00 start

- |         |   |            |
|---------|---|------------|
| Event 1 | 5 T EYE OPENER off 18 m   | Nom 60c    |
| Event 2 | RICHARD BANKS<br>MEMORIAL TROPHY<br>20 T D/B off 18 metres<br>Trophy 1st, 2nd, 3rd. Opt SS 50c.               | Nom \$6.00 |
| Event 3 | PRESIDENTS TROPHY<br>20 T Points off Handicap<br>Trophy 1st, 2nd, 3rd. Ladies Trophy.<br>O/S 50c.             | Nom \$6.00 |
| Event 4 | 10 T WALK-UP<br>Trophy 1st, 2nd, 3rd.   | Nom \$3.50 |
| Event 5 | 30 T DB OFF HANDICAP<br>Trophy 1st, 2nd, 3rd.<br>Calcutta will be held on this Event<br>50c O/S on first 15 T | Nom \$7.00 |

### NIGHT EVENTS

- |         |   |            |
|---------|---|------------|
| Event 6 | CENTRAL ZONE NIGHT<br>CHAMPIONSHIP DB<br>30 T off 16 metres<br>Trophy 1st, 2nd, 3rd. Badge Overall.<br>50c O/S on each 15 T   | Nom \$8.00 |
| Event 7 | 15 T S/B OFF HANDICAP<br>Trophy 1st, 2nd, 3rd.<br>50c O/S on first 10 T<br>HIGH GUN EVENTS 2, 3, 4, 5, 6, 7.<br>INTER HIGH GUN EVENTS 2, 3, 4, 5, 6, 7.<br>FRONT MARKER TROPHY. | Nom \$5.00 |

Lunch, Morning & Afternoon Teas Available.  
**BBQ AT NIGHT**  
Ammo.  
Refreshments on Grounds.

President:  
K. J. Harlow,  
Gidgee Street,  
Blackall.  
Phone 190.

Secretary:  
I. Murray,  
50 Rose Street,  
Blackall.  
Phone 91.

Committee reserves the right  
to alter program if necessary.

FUN IN THE SUN

# Sunshine Coast Gun Club

FUN IN THE SUN



Affiliated  
A.C.T.A. & Q.C.T.A.

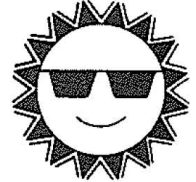

Pierces Ave.,  
Caloundra Q.

Clay  
Target  
Shooting

Clay  
Target  
Shooting

## SUPER SHOOT

JANUARY 20-28 1979

Specially packaged for shooters

SURFING	TRIPPING
SAILING	SUNSHINE COAST
FISHING	GUN CLUB
SUNSHINE COAST	JUST PLAIN RELAXING
GUN CLUB	SUN ON GOLDEN SAND

### WHEN?

January 20th to January 28th, 1979  
TRUE FAMILY HOLIDAY

Yes Dad you will keep Mum and the Kids  
Happy Too!!

### WHERE?

Sunshine Coast Gun Club  
Caloundra, Q'ld

BOOKINGS MUST BE MADE EARLY.

Hotels include: Dolphins Motel, Caloundra Safari Motel, Caloundra Motel, Mac's Motel

President:  
Doug Campbell  
P.O. Box 465  
Nambour Q. 4560.

Secretary:  
Bev Grice  
P.O. Box 22  
Moffat Beach Q. 4551.

LAZIN' IN THE SUN

TOURS

HOUSE OF  
BOTTLES

BIG  
PINEAPPLE

BIG  
COW

RAIN FORESTS

GLASSHOUSE  
MOUNTAINS

TANAWAH  
WORLD

COLOURED  
SANDS

# THE SILKWOOD AND DISTRICT GUN CLUB

## ANNUAL OPEN SHOOT

**SATURDAY 11-11-78 COMMENCES 1.00 P.M.**

**SUNDAY 12-11-78 COMMENCES 9.00 A.M.**

### SATURDAY'S PROGRAM

Event 1.	10 TGT D.B. E.O. OFF H.C.	Nom \$3.00
Event 2.	15 TGT D.B. OFF 16 M	Nom \$4.50
Event 3.	20 TGT D.B. \$100.00 H.C.	Nom \$6.00
DINNER		
Event 4.	10 TGT D.B. E.O. OFF 16 M.	Nom \$3.00
Event 5.	STATE DOUBLE BARREL POINTS SCORE NIGHT CHAMPIONSHIP 30 TGT OFF 18 M. TROPHY 1ST, 2ND, 3RD OPTIONALS EACH 15 TGTS	\$8.00 \$2.00
SATURDAY'S TOTAL NOMINATIONS		\$26.50

### SUNDAY'S PROGRAM

Event 1.	10 TGT D.B. E.O. OFF H.C.	Nom \$3.00
Event 2.	INNISFAIL GUN SHOP TROPHY 15 TGT P.S. OFF 16 M. TROPHY 1, 2 & 3	Nom \$4.50 Nom \$10.00
Event 3.	20 TGT D.B. \$200.00 H.C.	
LUNCH		
Event 4.	N.Q. S.B. CHAMPIONSHIP 20 TGT OFF 16 M. TROPHY 1, 2 & 3 OPTIONALS EACH 10	Nom \$6.00 \$1.00
Event 5.	THE JOE GALETTA TEAM SHOOT SHIELD 20 TGT P.S. OFF 16 M. (5 PER TEAM)	\$15.00/Team
Event 6.	10 PR D.R. OFF 16 M. OLIMPYC TARGET TROPHIES 1, 2 & 3	Nom \$6.00
SUNDAY'S TOTAL NOMINATIONS		\$33.50

### HIGH GUN — TARGETS TO COUNT

SATURDAY EVENTS 1 2 3 4 5 — SUNDAYS EVENTS 1 2 3 4 6

**THE COMMITTEE RESERVES THE RIGHT TO ALTER OR ABANDON ANY EVENT.**

Coloured Clays Will Be Used.

Normal Facilities are Available on the Grounds.

L. MORANDIN - PRESIDENT.

J. MIGUEL - SECRETARY.

### ENQUIRIES CAN BE MADE TO THE FOLLOWING:

J. MIGUEL 070 642200 — 8.00 A.M. — 4.30 P.M. MON. — FRI.  
J. STELLA 070 632140 — 4.30 P.M. — 9.30 P.M. MON. — FRI.

**QUEENSLAND CLAY TARGET ASSOCIATION**  
**Central Queensland**  
**Zone Championship**  
**GLADSTONE GUN CLUB**

**SATURDAY 25th NOVEMBER**

**SUNDAY 26th NOVEMBER**

**SAT. 25TH NOV 1978 — 9 AM**

Event 1

Nom \$4.00

**15 Tgt D.B. Handicap C.D.**

Event 2

Nom \$8.00

**30 Tgt D.B. 16 m**

Trophies to winners A B C Grades.

Event 3

Nom \$7.00

**30 Tgt D.B. - C. Q. Zone C'ship 16 m**

Trophies to 1st, 2nd, 3rd O/A.

Badges to winners of A B C Grades. Sash to Overall Winner.

Event 4

Nom \$7.00

**30 Tgt S.B. Handicap C.D.**

Cash Divide between winners of sections 11-14 m, 15-18m 19-21 m 22-25 m

NOMS 1ST DAY \$26.00

**SUN 26TH NOV 1978 — 8 a.m.**

Event 5

Nom \$7.00

**30 Tgt D.B. Points C. Q Zone Ch. 16 m**

Trophies to 1st, 2nd, 3rd O/A.

Badges to winners A B C Grades. Sash to overall winner.

Club Teams to shoot as squads competing on points basis for Port Curtis Yamaha Shield donated by Dick Burns, Gladstone. Each member of winning team will receive an engraved pewter mug.

Event 6

Nom \$7.00

**30 Tgt S.B. C. Q. Zone Ch 16 m**

Trophies to 1st, 2nd, 3rd O/A. Badges to winners A B C grades.

Sash to overall winner.

Event 7

Nom \$16.00

**45 Tgt D.B. Handicap**

1st 15 \$150, 2nd 15 \$150, 3rd 15 \$150 Overall \$200.

A MINI-CALCUTTA WILL BE RUN ON THIS EVENT  
AND WILL BE DRAWN DURING EVENT 6.

NOMS 2ND DAY \$30.00  
**TOTAL NOMINATIONS \$56.00**

High Gun Trophies for Overall, Intermediate, Ladies, Junior (16 and under) and Veterans (over 60) on kills over events 1 2 3 4 5 6 7 inclusive.

Meals, Refreshments and Drinks Available.

Billetted Accommodation Available

Gladstone President:  
Jim Elliott,  
"Koombooyana", Calliope.  
Phone 75 7162.

Three Traps Operating.  
Gladstone Secretary:  
Ray Schinkel,  
P.O. Box 907, Gladstone.  
Phone 78 1849.

Ladies Trophies won by M. Quince 16-25, M. Casagrande 13-25, K. Stafford 9-25. 20 pr DD off 16m: B. Murphy, P. Dallas 20-20, R. Wood, T. Bellamy 20-20 after shoot off.

A couple of tower events were held to complete the shoot program and a BBQ tea to wind up the day. It was overcast but fine for the day.

**ETON-MACKAY, 10-9-78.** — Fine, windy (18). 10t DB SS off Hcp: Possibles, D. Takagaki, R. Wood, T. Bellamy, S. Sartor. 20t Pts off 16m: T. Nielsen 60-60, S. Sartor, R. Miekle 58-60. 20t DB Pioneer Valley Dist Ch off 16m: A grade, T. Nielsen, B grade, S. Sartor. C grade, Mrs Clare Nielsen. 10 Pr DR off 16m: R. Miekle, P. Camilleri, M. Donald 14-20.

A pleasant day was had by all shooters, even though the attendance was low. I wish to thank Mr Colennis from Dysart for his attendance and also Mr R. Miekle from Tasmania. I do not wish to boast as to my winning the C grade championship, just to say come on ladies we can do it.

**GLADSTONE, 24-9-78.** — Warm and sunny. (44). 10t SB HC EO Sweeps: Two shooters shot the possible. R. Hannah, A. Gunston. 20t SB Hcp Club Ch) Cash Divide: Tree shooters scored 19. G. Ludwig, A. Atcheson (Rocky) and E. Chapman. After a shoot off E. Chapman became Club Champion. 20t DB Pts 16m trophies 1-2-3, Ladies Trophy: D. Robinson (Rocky), L. Busby 58-20. After shoot off L. Busby 1, O. Robinson 2, J. Elliot 3. Ladies trophy, T. Wallace. 30t DB Hcp (Club Champ) Cash Divide: The possible was hot by D. Robinson (Rocky), A. Gunston and K. Mackay (Rocky) with 29 2nd. A. Gunston became club champion.

Congratulations to D. Robinson from Rockhampton for taking out the H Gun. Four shooters lost a metre over this program, D. Robinson (Rocky), E. Chapman, T. Wallace, L. Busby. Visitors attended from Rockhampton and Callide-Dawson Clubs. We thank them for their attendance. A good day was shared by all.

**GOLD COAST, 20-8-78.** — Fine (58). Skeet: K. Hutchison, R. Weeden, C. Witt, R. Turner, C. Goldup, G. Harden, L. Pasquarelli 25-25. 15t DB Hcp Sweeps: C. Goldup, B. Witt, J. Ferrett, C. Harrison, A. Witt 15-15. 15t DB 16m Sweeps: L. Cobden, J. Ferrett, B. Smith, R. Weeden, L. Harden, A. Hicks, R. Turner, W. Stevens, T.J. Meadows, A. Witt 15-15. Gold Coast SB Ch 16m Badge OA trophies: A grade, R. Turner 28-30, J. Ferrett 27-30. B grade, J. Farrow 27-30, C. Witt 26-30. C grade, G. Mawer 26-30, W. McCarthy 26-30. D'Doubles draw partners 1/2 Hcp: 10 pr shooters shared 1st prize money.

FM H Gun: T.J. Meadows 50-60. H. Gun: J. Ferrett and R. Turner 57-60. Shoot off to be held at September shoot due to failing light.

**IPSWICH, 3-9-78.** — Fine. (52). 50t Qld Skeet Ch: W. Stevens 49-50 (Ips) 3-5 N. Keidge (Bris) 41-50. R. Lowry 52-54 (Ips) 6-10 P. Stein (Ips) 38-50. R. Porter 48-51 (Bris). 20t DB West Moreton Ch: A. R. Porter 20-20 (Bris) 11-12m S. Follett 16-20. OA & B, A. Palfreyman 27-29 (Bris), C. A. Ramsay 34-37 (Weipa). 30t DB Hcp trophy: S. Follett (Bris) 30-30, A. Palfreyman 30-32, P. Reedman 30-33. Best Ladies: A. Ramsay, C. Lowry. H Gun: A. Palfreyman 48-50.

Once again at Brisbane Club while they ran Qld Trench team event we ran Qld Skeet Champ. and Trap events. Naturally almost all shooters wished to shoot disciplines. Albert Palfreyman had a field day winning championship and second place in Trophy event. S. Follett won the 22 Auto in the Trophy event. The club wishes to thank all trophy donors for this shoot.

**KINGAROY, 3-9-78.** — Perfect (25). 20t DB trophies 16m: S. Horn 33-34 in shoot off from D. Schultz 32-34, M. Champney 19-20. Best 11-12m: M. Jones 18-23 in shoot off. 15t DB Pts SS Hcp: 1st, 2nd & 3rd shared by E. Fayle, E. Anderson, D. Schultz 44-45, W. Schultz 43-45, T. Hauritz, A. Wood 41-45, S. Horn 40-45, P. McDonald 40-45. 15t SB Trophies Hcp: D. Schultz 15-15, T. Crowe 14-15, A. Wood in shoot off from S. Horn 13-15. Best 11-12m: T. Crowe. Best Lady Shooter: B. Cairns in shoot off from S. Buchholz. Down the Line: M. Jones. H Gun: D. Schultz 49-50.

A good day for shooting but attendance was down, maybe on account of the coaching school and practice after, conducted by State coach Bill Stevens on the 27-8-78, also shooters may be saving up for the big Zone Carnival Shoot on 30-9, 1-10-78. Col Hawkins may have been present if his wife "TEE" had not presented him with a 6lb 13oz daughter just a few days earlier. A new set of lights to be installed and more night programs will be held in the summer months. Congrats to Darryl Schultz who just missed by one to get the coveted 50 Break badge. I'm sure he will make it next shoot.

**MARYBOROUGH, 27-8-78.** — Fine (32). 5t DB Pts Hcp: R. Osborne 32-33. 15t DB Pts Cont Hcp: T. Anderson 45-45, C. Harm 49-51, J. Cavanagh 47-51. 15t DB Hcp: J. Winnall 15-15, T. Anderson 50-51, D. Osborne 49-51. 5 Pr DR 16m: I. Casperson 13-16. H Gun: J. Winnall 42-45.

**MARYBOROUGH, 24-9-78.** — Fine, windy (29). 5t DB Pts 16m: L. Stolberg 21-21. 20t DB Pts Cont Ch: L. Stolberg 67-69, N. Farraway 66-69, W. Horton 58-60. 11-14 R. Osborne 53-60. 10t DB: T. Casperson 42-42, W. Horton 41-42. 10t DD 20m: I. Casperson, P. Shaw 12-13.

**MOUNT ISA, 10-9-78.** — Fine, warm and still. (41). 25t Skeet SS Hcp & H Gun: 15 shooters shot possibles. H Gun was won by A. Lord who was also the first shooter to shoot 25-25 on the Mount Isa Skeet layout. 10t DB Pts EO Hcp: Six shooters scored possibles. N. Filopolous, F. Novinetz, L.C. Wilcocks, K. Ford, M. Bunarciar, T. Kittila. 20t OB Cont, 16m for Mt Isa GC PB Cont Ch: Won by W. Burke (Richmond 37-37 after a shoot off. J. Storch 36-37, N. Kuskopf 24-25. 5t SB Hcp EO: Six shooters shot possibles. N. Filopolous, B. Hart, R. Street, K. Wyld, E. Sebastian, F. Novinetz. 30t SB Hcp Club Perp trophy: Won by J. Storch 45-47, J. Hart 44-47. Best 11m: V. Casey 22-30 (Mary Kathleen), Best 12-14m: K. Wyld 27-31.

H Gun was won by J. Storch after a shoot off 77-83. Best Junior M. Buhargiar 59-65. Best Lady shooter, B. Lord 45-65. 11m H Gun: M. Temple (Mary Kathleen).

**MURGON, 3-9-78.** — Good (38). 20t DB 16m: A — I. Casperson 31-31, B — G. Doblo 39-39, C — P. Maguire 25-25. 20 Pr DB Murgon Ch: B. Rowsell, R. Cosier 20-20, E. Kath, R. Duffin 19-20. 30t DB Hcp: B. May 31-31, G. McCly-

mont 30-31, L. Stolberg 41-42. 20t SB 16m: A — J. Winall 24-25, B — R. Berry 28-29, C — D. Campbell 19-20. 10t DB Hcp: R. Berry, B. Rowsell, D. Campbell.

Inter H Gun: J. Berry 61-70, H Gun: G. McClymont 68-70. Brian May of Sunshine Coast advanced from 16 to 17m.

**PORT DENISON, 27-8-78.** — Windy, cool (35). 15 SB Hcp: J. Murray 14-15, M. Jewell, C. Hailer, G. Zanussi 13-15. 10 DB Patrons Trophy Hcp: C. Wellington 10-10, J. Facey 10-10, V. McDonnell 10-10. 20 DB Trophy off 16m: T. Laspina 20-20, M. Williams 19-20, N. Sleeman 19-20. 20 DB Hcp: G. Nicol, G. Milani, B. Johnson 20-20, A. Maltby, V. McDonnell 19-20. 4 Pr Deauville Doubles off 16m: D. Killick, R. Mau 1st, V. McDonnell, D. Pugh 2nd.

Visiting shooters from Orange (NSW), Charters Towers, Burdekin. Junior Trophy donated by Magees Supermarket and shot in conjunction with event four was won by Roy Facey.

**RICHMOND, 19-8-78.** — Windy. (50). Presidents Trophy: J. Storch, B.J. O'Neill, M. J. Donald, Horrie Balt team shoot: won by Mt Isa Old Boys, C. Selke, G. Casley, F. Pauza, T. Kittila, G. Beurchler; High Gun: F. Pauza. Flinders River DB Night Ch: T. Kittila, F. Pauza, G. Lillyman.

**RICHMOND, 20-8-78.** — Good. (52). Flinders River DB Ch: D.I. Murray, A. Kenna, C. Buhagiar. Angus Smith Sport Store trophy: F. Novinetz, B. Hart, M. Buhagiar. \$300 Hcp: 1st and 2nd shared by S. Baries and J. Storch, 8 shooters shared 3rd.

Very successful shoot with visitors from Mt Isa, Charters Towers, Townsville and Keragga. Congratulations to F. Pauza of Mt Isa who shot very well to win overall H Gun. Thanks to club ladies who catered for all very well.

**ROCKHAMPTON, 3-9-78.** — Good (38). 20t DB KILLS, 16m: D. Robinson 61-61, G. Whitfield 60-61. 20t DB Pts Hcp: W. McLeod 60-60, K. Mackay 59-60. 10t SB off 16m: L. Talbot 15-16 after a shoot off with L. Dalton (Gladstone), W. Warner and R. Hannah (Gladstone). 10 Pr DD off 20m SS: G. Talbot and L. Talbot eq 1 10-10, G. MacFarlane, J. Watson 10-10.

High Gun won by W. McLeod 47-50. Ladies first was R. McLeod with 41-50, second J. Thomas 40-50, third K. Smith 38-50. Thanks to visitors from Gladstone, Biloela and Clermont.

**ROMA, 16-8-78.** — Perfect (18). 15 DB Hcp: R.M. Dean, D. Bowman 14. 15 DB 16m: G. Latemore 15, R.A. Dean, G. Bryant, C. Reid 14. 15 SB 16m: V. Tipman, G. Bryant 14. 15 DB Pts 16m: R.A. Dean 44, C. Reid 42, V. Tipman, G. Latemore 40. 5 Pr DR Champ of Champ: R.A. Dean, G. Latemore, V. Tipman.

Club welcomed old member Herb Carne from Gold Coast.

**SCRUBBY CREEK, 10-9-78.** — Fine (48). 15 B Pts Ch 16m: W. Bredhauer (Scrubby Ck), K. Harlow (Blackall), G. Jarvis (Tambo). 10 B SB Hcp: R. Read (Scrubby Ck), T. Jarvis (Scrubby Ck), P. Sargood (Tambo). 20B DB Hcp: J. Cutler (Tambo), B. Marks (Scrubby Ck), W. Bredhauer (Scrubby Ck). 10 Prs Deauville Dbls: G. Jarvis/J. Cutler (Tambo), K. Harlow/J. Webber (Blackall), M. Jarvis/R. Jarvis (Tambo). 5 Prs DR: B. Marks (Scrubby Ck), D. Turnbull (Scrubby Ck). High Gun P. Sargood (Tambo); Inter. High Gun: I. Murray (Blackall).

**SUNSHINE COAST, 17-9-78.** — Sunny. (26). 30t DB Pts Hcp Jackpot: 11-16m F. Hall (SCGC) 90-30, K. Howard (SCGC) 83-29, Q. Porfiri (SCGC) 81-28. 17-25m: L. Stolberg (Gympie) 88-30, share 2nd, 3rd R. Chapman (Bris), Bev Grace (SCGC) 84-29. 30t DB Pts Ch: OA Q. Porfiri 88-30 (SCGC), A grade, B. Rowsell 87-29 (Murgon), B gr. Q. Porfiri 88-30 (SCGC), C gr, W. Nioa 103-37 (Gladstone). 30t SB 16m: 11-15, T. Anderson 29-30 (Gympie), 16-18, L. Stolberg 32-32 (Gympie), 19-25, N. Bullimore 29-31 (Bris). 20t DB 16m: L. Stolberg 39-39 (Gympie), B. Dunne 38-39 (SCGC), Bill Stolberg 28-29 (Gympie). H Gun OA, L. Stolberg 109-110 (Gympie), Inter H Gun, F. Hall 98-110 (SCGC).

Congratulations go to Lex Stolberg from Gympie who shot 109 out of 110 targets. He obtained his 75 Break Badge. Commiserations must go to Quinto Porfiri who also shot well with a score of 108-110. Congratulations to T. Anderson who lost 1m. Very small shoot. Club pleased to welcome Bill and Jenny Nioa from Gladstone. Also Sel Horn from Kingaroy along with our usual visitors from Gympie, Murgon and Brisbane.

**TOOWOOMBA, 10-9-78.** — Fine, sunny (42). Skeet 1 round graded: 0-1 A. Stewart 37-37 (3 possibles), 2-4 R. Goodall 21-25, 5-10 T. Gill 20-25. Skeet 1 rnd ISU Gr: 0-1 G. Turner 20-25, 2-4 K. Mott 14-25, 5-10 T. Gill 6-25. Trap Ev 1 Toowoomba Mixed tar ch: Overall & A grade, M. Hass 24-25, B gr, P.

**Preliminary Notice**

# **GOLD COAST GUN CLUB**

## **January Carnival**

### **20th & 21st JANUARY, 1979**

**FOR FULL DETAILS**  
**SEE DECEMBER ISSUE**

Rapisarda 21-25, C gr, J. Bourke 23-25. Ev 2 15t DB Hcp: D. George 47-47 (5 possibles), S. Mylne. Ev 3 15t Cont Pts 16m: A gr, A. Stewart 45-45. B gr, A. Sceresini 44-45, C gr, J. Bourke 45-45.

Perfect conditions for both skeet and trap events. ISU Skeet scores continue to improve. Main trophy winner was J. Bourke with 3 wins in trap events. Main event for the day won by club captain M. Hass with an excellent 24-25 in mixed target championship. Tower Hut now complete and ready for light installation. Skeet H Gun, G. Turner 42-50. Trap H Gun, J. Bourke 53-55, Overall H Gun, M. Hass 88-105, Best 11m shooter Ev 2, D. Kelman.

**WARWICK, 3-9-78.** — Fine. 20t Southern Downs Pts 16m Ch: OA R. Van Wyk. A gr, K. Stevens, P.R. Evans. B gr, S. Bartley, C. Kassulke. C gr, T. Shultz, D. Cox. Wck Gun Club Trophy Event 30t 16m: J. Lee, G. Newey, D. Deluca, D. George, R. Wells, P.R. Evans, A.J. Smith, S. Bartley, L. Bartley, C. Kassulke. \$750 Cash Hcp: OA P. R. Evans, D. Deluca, K. Murphy. 1st 20 pts: M. Short, S. Gray, H. T. Thompson, K. Murphy, J. Ryan, P. R. Evans, N. Baker, D. J. Campbell, R. Wells, L. Zambelli, S. Reinke, R. Deluca, D. B. Eather. 2nd 20 pts: S. Bartley, K. Murphy, P. Evans, E. Hass, R. Potter, G. Newey.

Numbers were down for our Annual Shoot. We still had 62 shooters from Orange, Brisbane, Lismore, Tenanora, Lakes, Toowoomba, Ballandean and Warwick and Texas. H Gun P. Evans, Front Marker, D. George.

## Arthur Kenna Reports for CTSN

On the 19-20th August all roads in North Queensland led to the Richmond Gun Club, a one trap club located in North West Queensland about 400 miles West of Townsville. Richmond is also the home town of well-known shooting identity, Doug Murray.

The annual shoot at Richmond is again becoming a major shoot on the Northern calendar. This is mainly due to the tremendous hospitality shown to visitors by Keith Kelman, his committee and their families.

The total attendance at the shoot was 50 (best attendance since 1950) this included visitors from Mt Isa, Winton, Julia Creek, Charters Towers, Townsville and local areas. Junior shooters seemed to be ever present amongst the winners over the weekend.



• Left to Right: T. Kittila (Mt Isa), F. Pauza (Mt Isa), M. Donald (Mt Isa), J. Storch (Mt Isa).

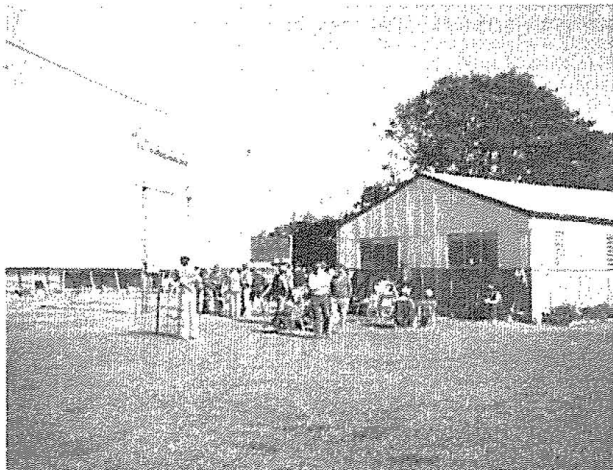

• View of the Richmond Gun Club Shooting Area (Qld).

First event on the program was the President's trophy. This was the only event for the weekend that did not have a junior or young shooter in amongst the winners. First place went to J. Storch from Mt Isa, second was B. J. O'Neil of Richmond and third M. Donald of Mt Isa.

Flinders River Night Double Barrel Championship, overall and A Grade, T. Kittila of Mt Isa; B Grade C. Lillyman, Richmond; and C Grade was F. Pauza, Mt Isa (junior).

Event 3 was the Flinders River Double Barrel Day Championship. C Grade and overall was won by Don Murray, Richmond; A Grade, A. Kenna and B Grade, C. Buhagiar, Townsville.

The Angus Smith Sports Store trophy was won by F. Novinetz, Mt Isa; second, B. Hart, Mt Isa (junior) and third M. Buhagiar, Townsville (junior).

The last major event for the weekend was the highly contested Harry Batt team shoot. This event was won by the Mt Isa old boys. The high gun for the event was won by F. Pauza, Mt. Isa.

Overall high gun for the weekend was also won by a junior shooter, F. Pauza of Mt. Isa.

And so ended another enjoyable shoot, and the Richmond boys really showed the larger clubs how a full program and fifty shooters could be handled over one layout.

## A First for Townsville

During the August holidays this year the Committee of the Townsville Gun Club gave permission to conduct a coaching camp for the junior members of the club. The camp ran for two and a half days making three nights camping out for the boys, the other half day was devoted to coaching ladies.

Both Down-the-line and Skeet shooting was covered over the three day period. Other activities including gun safety, shooting rules, safety on the shooting tracks, gun maintenance, film evening, games, hiking, physical education and tall story telling (Daves woppers).

A total of nine boys and Dot our cook, attended the camp (without Dot there would have been some very hungry boys around). A tremendous time was had by all (including the coach) and this was mainly due to the co-operation of the boys who were always willing to help with the odd job around the camp.

A special thanks goes to Winchester Australia for the donation of cartridges and the use of their films for the film evening, Blue Dot Clays for their donation of clays, Angus Smiths Sports Store and Merv, our handyman.

The newly appointed Zone Coach, Tom Comerford, with the aid of club coaches in the area, hopes to consolidate what the boys have learnt by conducting a similar camp over the Christmas holidays, this time including junior shooters from the whole of the Zone. ○



• Back row, L. to R.: J. Edwards, T. Comerford, R. Carty, R. Boscacci, T. Hoer. Front row, L. to R.: I. Aitken, D. Edwards, A. Pearson, T. Comerford (Jnr), D. Crawford (Cook).

QUEENSLAND  
CLAY TARGET ASSOCIATION

SOUTH EASTERN ZONE CARNIVAL 1978

BRISBANE GUN CLUB

SATURDAY 11th NOVEMBER  
commencing 1.00 p.m.

SUNDAY 12th NOVEMBER  
commencing 9.00 am

Saturday

1.00 p.m.

Event 1.	30 Target DB Graded 16 m C/D	Noms \$7.00
Event 2.	30 Target DB Zone Championship 16 m	Noms \$7.00

Due to unforeseen circumstances the night program  
has been cancelled.

Sunday

9.00 a.m.

Event 3.	30 Target DB Points Zone Championship 16 m	Noms \$7.00
Event 4.	30 Target SB Zone Championship 16 m	Noms \$7.00
Event 5.	15 Pair DR Zone Championship 16 m	Noms \$7.00

Championship Events are for Overall and A B and C Grades.

Winners of Championships receive a Sash, Badge, and Grade Trophy,  
Grade winners receive Badge and Trophy.

All Trophies to be \$50.00 Value.

Sash for High Gun, Ladies High Gun, and Inter. High Gun.

In addition to the championship events a club teams event will be conducted. Clubs are to nominate a team or teams and winning five members of the team will receive a Badge. Teams are to be of six members with one score not to count.

Shooters are urged to attend this shoot as nominations are low, prizes are excellent, and as this is the inaugural Zone shoot it is hoped that a good response from shooters will enable the shoot to be the success that it will.

Zone President  
D. F. Campbell QGM.  
P.O. Box 465  
Nambour.  
Phone 071 411436 Bus.  
071 411971 A/H.

Zone Secretary:  
Mrs B. Hall,  
P.O. Box 465  
Nambour.  
4560. Qld.

Brisbane President:  
David Evans.

Brisbane Secretary:  
Mrs Chris Payne.  
Ph. 3984555.

# International Gun Club

**SUNDAY  
12TH  
NOVEMBER  
AT 9.00 A.M.**



**YES IT'S  
THE BIG ONE**



**NOT 1**

**NOT  
2**



**3**

**ONE FOR  
EACH  
GRADE  
(A, B AND C)**

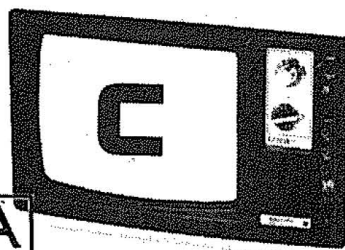

**COLOR  
TV  
SETS**

**VIRGINIA  
S.A.**



**RANK ARENA**

34cm Portable

**IN THE**

## **ANNIVERSARY GRADED SHOOT**

**25 TARGETS – NOMINATION A LOW \$14.00**

**FULL SUPPORTING PROGRAMME:**

**50 TARGETS – ANNIVERSARY TRENCH CHAMPIONSHIP**

**NOMINATION – \$8.00**

**25 TARGETS – SPARNON BROS HANDICAP**

**NOMINATION - \$5.50**

**5 TARGETS – CASE OF CARTRIDGES HANDICAP**

**NOMINATION – \$3.00**

**SWEEPSTAKES AVAILABLE ON ALL EVENTS**

# **DON'T MISS THIS ONE!!**





# SOUTH AUSTRALIA

**BARMERA, 3-9-78** — Cold and wet (14). EO 10t SS DB 16m: 10-10 R. Maywald, I. Maywald, L. Pfeiler, P. Caddy, Club DB Champ off 16m 1st by Barmera Hotel: I. Maywald 20-20, P. Caddy 20-21, L. Pfeiler 19-21; FM T. Shaddock. Clark's Superfoods Skeet Hcp: C. Bradtke 58-58, R. Howell 52-58, B. Spencer 51-54. 20t Hcp SS: T. Shaddock 20-20, M. Trout, R. Maywald, L. Pfeiler, B. Spencer, C. Bradtke 19-20. 5t off 11m 5t of 25m SB: M. Trout D. Pfeiler 8-10. High Gun: L. Pfeiler.

Thanks to Clarks Superfoods for 1st in Skeet Handicap and to Barmera Motel Hotel for 1st in Club DB Championship.

**BORDERTOWN, 16-9-78** — Fine and windy (52). DB Ch: 'A' & OA P. Cleggett Jnr 64-64, 'A' T. Scott 63-64, N. Hinnerberg; 'B' H. Faux 62-63, J. Hinge, R. Semmler; 'C' M. Whelan 53-54, 2nd & 3rd divided between 6 shooters G. Gehlig, G. Block, B. Case, G. Jolly, C. Steer, J. Manz. 10t Cont 10t PS: B. Wagg, R. Andrews 40-40, G. Dinning, H. Faux, J. Hinnerberg, D. Plummer, E. Hall 39-40.

Congratulations to Peter Cleggett who will be shooting in the Champion of Champions shoot-off at Bordertown Christmas Shoot.

**BUTE, 27-8-78** — Very cold (17). EO: divided E. Commons, R. Enright, I. Stock, Jim Stock. Mid West PS Ch: E. Commons 'A' 52-60, D. Lane 'B' 52-60, B. Thompson 'C' 43-60. Charles Moore Trophy: Jim Stock 18-20, F. Atkinson 23-26, I. Pretlove 22-26.

A very cold day, but everyone enjoyed themselves and some very good shooting, thanks to all who helped in any way.

**BUTE, 9-9-78** — Fine and warm (23). EO: divided T. Pretlove, M. Roach, R. Hocky, G. Read, M. Ralston. Birthday Shoot in conj T. J. Burke Mem.: I. Stock 25-26, Jim Stock 24-26, F. Atkinson 20-22. Elliot Bros Trophy: M. Roach 19-20, L. Zanker 28-30, I. Pretlove 27-30. EO Night: divided H. Baynes, P. Wiedenbach, R. Ralston, L. Zanker, M. Roach, R. Enright, D. Lane, I. Stock. Mid Nth Night Ch: 'A' E. Commons 25-26, 'B' D. Lane 19-21, 'C' I. Pretlove 18-20. High Gun over afternoon 1 2 3 events: won by M. Roach 51-58.

A beautiful day. Sorry we didn't have more in attendance but all present had a lovely time. Thanks to all who helped in any way.

**FAR WEST, 17-9-78** — Windy and overcast (11). 5t EO 16m: R. Pitt, G. Burnett, T. Heard 15-15. 25t DB Club Ch: T. Heard 28-31, R. Pitt 27-31, G. Burnett 21-25. Ladies Trophy: Mrs J. Curtis 20-25. 25t DB Hcp: R. Pitt 25-25, P. Myketasch, G. Burnett 23-25. 25t SB Hcp: D. Lynn 25-25, R. Pitt, T. Heard, C. Thompson 21-25. 10pr DD: Mrs P. Jeffree and R. Pitt 10-10, P. Myketasch and T. Heard 9-10, M. Curtis and P. Myketasch 7-10.

**INTERNATIONAL, 9 & 10-9-78** — Fine (60). Australian National Trench Ch: P. Burgess 191-200, F. Rapley 189-200, T. Rumbel 186-200 (won on a count back between T. Rumbel, K. Lowry and T. Budd). 'AA' P. Burgess 191-200, T. Rumbel 186-200, 'A' F. Rapley 189-200, T. Budd 186-200; 'B' R. Walker 175-200, D. Ayres 171-200; 'C' R. Mark 170-200, P. Marcioui 167-200. Cash Hcp: divided between R. Grant, A. Dipaolo, A. Tosolini, J. Allison, D. Osborne, E. Stramere. Clarksons 16m Graded Shoot: 'A' G. Hill 25-25, J. Byrnes 36-37; 'B' L. Martin 35-35, L. W. Francis 34-35; 'C' P. Baxter 25-25, C. Verbis 25-26. Festival City DB Ch: 'A' L. Nuzzolese 59-60, R. J. Cook 58-60; 'B' R. Dwyer 32-33, D. Panazolli 28-29; 'C' P. Baxter 80-80, M. Romeo 24-25. Overall and High Gun: P. Baxter 80-80.

**LAKE ALBERT, 3-9-78** — Calm and cool (37). 5t EO: 12 shooters share sweeps. 20t Fisher Firearms Hcp: G. Durbridge 20-20, T. Selby 38-39, J. Harding 37-39; FM T. Austin 19-20. 20pr Blue Wing DD drawn partners: C. Steer and M. Harding 19-20, D. Plummer and F. Cleggett 17-20. 10pr DR Sweep: R. Ritchie 16-20, equal 2nd R. Semmler and W. Kavanagh 15-20.

A good smooth day's shooting. Many thanks to visitors from Robe, Wilkawatt, Mt. Barker, Bordertown, Taillem Bend and Adelaide.

**LOXTON, 17-9-78** — Windy, cold (20). EO 5t WU: H. Reinders, P. Caddy 4-5. 10t WU: P. Caddy 7-10, H. Reinders, L. Pfeiler 6-10. Skeet Hcp: H. Reinders 25-25 (off gun 24-25), P. Caddy 24-25 (off gun 24-25), R. Whyllie 24-25 (off gun 22-25). High Gun: P. Caddy 35-40.

**MALLALA, 10-9-78** — Warm and breezy (23). 5t EO PS SS CD: 15-15 P. Weidenbach, 14-15 W. Reilly, R. Franks. 25t Medley S. Hayden Trophy: 22-25 F. Starling, 20-25 R. Franks, P. Jarmyn. 5t DR SS CD: 8-10 P. Jarmyn, 7-10 W. Liddicoat, F. Wintulich, J. Ronan, R. Franks, B. Zanker. 10t Cont SS CD: 9-10 B. Zanker, 8-10 J. Ellis, P. Jarmyn, W. Reilly.

**MALLALA, 24-9-78** — Pleasant (30). 5pr DR SS CD: 8-10 G. Hommelhoff, R. Smith, 7-10 H. Mellowship, J. Boon. 15pr DR Ch Hamrey Bridge Trio Trophy: 'A' & OA 24-30 J. Holder, 'B' 23-30 F. Wintulich, 'C' 22-30 K. Morgan. 10t Cont SS CD: 9-10 F. Starling, R. Franks.

**MANNUM, 27-8-78** — Fine and cool (52). 4pr DR EO: divided between T. Niven and B. Hill. DD drawn partners 10pr: T. Niven and T. Pasfield 29-31, D. Semmler & P. Marcioui 28-31; clays only D. Jaensch and J. Jaensch 16-20. Club DD Ch 10pr own partners: G. Steele and T. Niven 11-11, J. Longbottom and R. Surfild 10-11.

Good attendance for new electric traps.

**MT GAMBIER, 10-9-78** — Fine and mild (45). 10t EO: R. Branch, L. Megaw, K. Mules, J. Humphris, G. Rrost, D. Pratt, D. Francis, F. Taylor, L. Preece, M. Medhurst, K. Holmes 10-10 divided. Club DB Ch: OA & 'A' J. Humphris 43-43, J. Murphy 24-25; 'B' G. Todd 20-21, K. Holmes 31-32; 'C' G. Frost 42-43, F. Manser 19-20. Club Mixed Tgt Ch: G. Todd 23-25, L. Megaw 48-54, K. Holmes 45-54. FM I. Hetherington.

**MANNUM, 17-9-78** — Cold and raining (32). A. Wohlfeil Hcp 20t: P. Weidenbach 27-27, M. Harding 26-27, N. Johncock 31-32; FM R. Sandow 15-20.

Lower Murray WU Ch 15t: OA & badge B. Hill 13-15, 'A' B. Hill 13-15, J. Maczkowiack 11-15; 'B' C. Wohlfeil 14-18, H. Mellowship 13-18; 'C' G. Harding 11-16, M. Harding 10-16. High Gun medallion: B. Hill 31-35.

**MT GAMBIER, 23-9-78** — Fine, windy (74). Eley Teams Shoot: South East 293-300, Wimmera 292-300, Western Dist 290-300. High Gun: F. Taylor 44-44 (Mt Gambier). Eley DB Graded Ch: OA J. Humphris, 'A' A. Flack, J. Allison; 'B' W. Hetherington, T. Drummond; 'C' G. Yoannidis, N. McKinnon; FM G. Woods.

For the first time a Championship was conducted instead of a Handicap event, following The Eley Teams Shoot, this change proved very successful.

**PORT AUGUSTA, 20-8-78** — Good (13). 10t Cont Sweep EO: D. Lane, R. Bisi, B. Worden, Gary Bollen divided 9-10. 30t DB 16m Cont.: Gary Bollen 29-32, R. Bisi 28-32, R. Seaman 26-30.

**PORT LINCOLN, 3-9-78** — Cold and raining all day, windy (16). 5t DB Hcp: 5 shooters 5-5 C. Woolford, M. Keenan, A. Phillips, T. Dipaolo, T. Forrester. 10t DB Hcp: 5 shooters 10-10 C. Woolford, M. Keenan, T. Trewartha, T. Dipaolo, T. Forrester. 5t WU: 5 shooters 3-5 J. Woolford, C. Woolford, A. Phillips, B. Kovacic, A. Dipaolo. 10pr DR: T. Forrester and J. Schramm 12-20, M. Keenan and J. Curtis, J. Jeffrey and B. Trenwith 10-20. Over Day: C. Woolford, T. Forrester shoot-off, 3rd J. Schramm (shoot-off with A. Dipaolo). 20t DB Hcp: J. Jeffrey 23-23, M. Keenan 22-23, Mrs —. Curtis 17-20.

A very miserably cold day. The Fisher Firearms Trophy was won by Chris Woolford after a shoot-off with Trevor Forrester. Winning 225 cartridges. Trevor Forrester came 2nd winning 125 cartridges. Jim Schramm came 3rd winning 75 cartridges — all donated by Fisher Firearms. Trophies for the last event were donated by the Club Vice-President Chris Woolford. Best 11m shooter Joe Jeffrey; Best Lady Shooter Joy Curtis.

**ROBE, 17-8-78** — Turned windy and rain (69). 10t EO: 17 shooters share Sweeps. 20t Dist DB Ch: P. Cleggett Jnr 58-58, T. Reschke 57-58, A. McIntyre 42-43. 15t Hcp: K. Boston 20-20, T. Niven 19-20, W. Irvine 16-17.

**S.A.G.C., 23-8-78** — Cold (40). Cash Hcp: equal 1st M. Romeo, R. Cook 20-20, equal 3rd D. Graney, R. Webster, R. Dower 19-20. DB Ch: OA & 'A' R. Dower 20-20, S. Williams 28-29, R. Mules 27-29; 'B' R. Cook 26-27, L. Martin 25-27; 'C' R. Dower (Dverall) 20-20, D. Prescott 20-23.

Good attendance for a Night Shoot.

**S.A.G.C., 30-8-78** — Good, no breeze (40). Cash Hcp: R. Enright, A. Foreman 20-20, V. Ielasi, R. Cook, R. Webster 19-20. 16m Graded: 'A' R. Mack 20-20, D. Graney 19-20; 'B' L. Francis 20-21, D. Harris 19-21; 'C' R. Dower R. Thompson 19-21.

**S.A.G.C., 2-9-78** — Miserable (67). R. Ashby Hcp: S. Byrnes 28-28, A. Jarmyn 27-28, C. Hunt 20-21. City of Salisbury DB Ch: 'A' & OA E. Hall 44-44, D. Graney 55-56; 'B' K. Sandercock 31-32, T. Stratford 20-21; 'C' R. Pitt 20-20, R. Dower 21-22. Ladies Trophy: Mrs J. Gawith 17-20. High Gun of the day: C. Hunt 40-40; Taipan 11m Agg: R. Sandow 33-40.

**S.A.G.C., 3-9-78** — Mild and windy (104). Club Skeet Ch inc Eley Shield: OA R. Kimber 49-50; 0-1 J. Murphy 48-50, G. Bollen 47-50; 2-4 K. Zaniol 46-50, E. Stramere 45-50; 5-10 P. Dunk 54-59, J. Ellis 53-59. Club DB Ch: OA T. Reschke 137-137; 'A' T. Reschke 137-137, E. Hall 98-99; 'B' R. Wimshurst 136-137, K. Zaniol 34-35; 'C' S. Depalma 73-74, F. Speelchly 64-65. Winchester Tournament: R. Kimber 64-64, D. Graney 63-64, L. Martin 61-62, I. Campbell 53-54, T. Reschke 45-46, J. Clarke 44-45, J. Byrnes 43-44, T. Morris 39-40, B. Watt 39-40, P. Mules 35-36; Veteran Trophy: E. Commons 30-30; Ladies Trophy: F. Gibson 28-30; Junior Trophy: W. Pretlove 26-30. 11-15m Trophy: R. Dower 34-35.

**S.A.G.C., 6-9-78** — Cold and windy (28). Cash Hcp: T. Jenkin 20-20, R. Webster, D. Prescott, R. Dower, G. Oakes, R. Ritchie, A. Mules all 18-20. 16m Graded Tourn.: 'A' K. Mules 20-20, R. Andrews 19-20; 'B' R. Ritchie 18-20, L. Francis 11-20; 'C' W. Rees 19-20, V. Ielasi 18-20.

**S.A.G.C., 13-9-78** — Cold, wet, windy. Cash Hcp: S. Williams, D. Stefanato 20-20, D. Graney, A. Foreman 18-20. 16m Graded: 'A' R. Cook 30-32, P. Mules 29-32; 'B' L. Francis 19-20, E. Stramere 17-20; 'C' A. Foreman 18-20, R. Dower 18-20.

**S.A.G.C., 17-9-78** — Windy, intermittent rain. State ISU Skeet Ch: OA 4-10 F. Guyatt 92-100, R. Kimber 80-100, J. Ralston 77-100; 4-10 J. Ralston 77-100, D. Foster 73-100, G. Loveband 72-100. J. Hamilton Mem Hcp: 11-15m L. Cimarosti 29-31, P. Munting 28-31; 16-20m C. Hunt 27-28, T. Morris 26-28; 21-25m R. Franks 18-20, R. Mules 17-20. DR SS: L. Francis, C. Hunt, E. Commons 7-10. Cont Sweep: J. Byrnes, E. Stramere 10-10; C; Hunt, S. Depalma, D. Graney 9-10.

P. Munting, new member, lost a metre when doing his card. Please make it C12.

**S.A.G.C., 20-9-78** — Mild and calm. Cash Hcp: R. Smith, K. Pattison 20-20; D. Foster, L. Francis, L. Martin, F. Agostino shared 3rd all 19-20. 16m Graded: 'A' L. Martin 35-35, D. Weidenbach 34-35; 'B' R. Smith 19-20, T. McKenna 19-21; 'C' A. Foreman 20-20, J. Fleetwood 18-20.

**SOUTHERN, 20-8-78** — Overcast, cool, slight breeze (33). EO SS: 12 divided. Super Elliott DB Hcp 20t: W. Longbottom 15.0 25-25, R. Hutchinson 19.0 24-25, R. Hill 17.0 30-31; ydge E. Smith 13.0 29-31. Sthrn Dist SB Ch 20t: 'A' & badge J. M. Clark 25-27; 'B' C. Wohlfeil 24-27; 'C' W. Longbottom 18-21. Taipan High Gun Cup: W. Longbottom 43-45.

**SOUTHERN, 10-9-78** — Warm, slight breeze (26). EO 5t: 7 divided. S.A. Sportsgoods DB Hcp 20t: K. Hobbs 12.0 34-34, K. Morgan 14.0 33-34, B. Newell 11.0 21-22; ydge R. E. Mueller 11.0 22-23. G.C. Club WU Ch 20t: R. Rossiter 18-25, W. Brown 17-25, B. R. Brown 19-35. Taipan High Gun Cup: W. A. Brown 37-45.

**S.Y.P., 13-8-78** — Fine but cold (17). Taipan Prog Pts Hcp: F. Atkinson 55-60 pts, W. Smith, C. Rawlings. Club Mixed Tgt Ch Minhton Hotel Trophy: L. Francis, W. Smith, F. Atkinson.

The Shoot was well attended and enjoyed by all. The visitors from Adelaide found the Mixed Targets a break from the normal run of shoots but

a result was found nevertheless won by L. Francis followed by W. Smith and F. Atkinson. Fred had a successful day by winning the first event as well followed by W. Smith and Col Rawlings.

**UNGARRA, 10-9-78** — Warm, windy (20). Skeet Hcp: 5 way divide between Mick Keenan, Roy Pitt, Tom Bagshaw, Barry Trewith and Rodney Gregurke. Skeet Ch: won by Tom Bagshaw 23-25, Max Curtis 25-29, John Baldissera 21-26. 20t DB Hcp: Joe Jeffree 24-24, Tom Bagshaw 23-24, Mick Keenan 25-26.

Good attendance from Port Lincoln Gun Club. Main event - Skeet Championship won outright by Tom Bagshaw with 23-25. He won a mounted man and a badge plus the Tarlina Murray Grey Stud Trophy for his effort. A shoot-off for 2nd place saw Max Curtis winning from John Baldissera. Joe Jeffree a late arrival won the DB event from Tom Bagshaw after a shoot-off. The foundation for the toilet block has been completed and improvements for our big October Shoot are well under way.

**WILKAWATT, 9 & 10-9-78** — Sat cool, cloudy; Sun sunny and windy (33 & 36). 20t Anniversary Gun Hcp: K. Cornwell 38-38, R. Ritchie 37-38, P. Johncock 27-28; encouragement N. Killick 19-20 11m. 10t SS Ch: D. Beelitz, R. Ritchie, C. Steer, B. Killick 10-10. 20t Night DB Ch: 'A' P. Griggs 20-20, W. Hayward 18-20; 'B' & OA R. Ritchie 38-38, F. Sommerfield 37-38; 'C' J. Ramke, C. Steer 20-24; Taipan High Gun: R. Ritchie 55-55.

Sunday 10th - 20t Country Motors Hcp: J. Cornwell 38-38, J. Mack 37-38, D. Beelitz 34-35; encouragement S. Killick 18-20. 20t Cash Ch: 11-13m S. Killick \$10, C. Steer \$10; 14-16m D. Semmler \$20; 17-20m B. Killick \$10, W. Hayward \$10. Taipan High Gun: D. Semmler 44-45.

Congratulations to Keith Cornwell on good shooting and winning our Anniversary Gun Hcp. Winning a Weatherby Auto Shotgun. Many thanks to trophy donors.

## South Australian Clay Target Association

announce  
the first State Novice  
Coaching Seminar

- When? November 5th, Sunday, commencing at 10 am
- Where? S.A. Gun Club, Bolivar.

## 1978 ISU Skeet Championship



● John Summers at Station 7 while Graeme Boyd and Fred Guyatt wait patiently. (Photos by John Ellis).



● Group of competitors at the 1978 ISU Skeet C'ships, Adelaide — Left to right, back row: Harry Somers, R. Johncock, Graeme Boyd, Peter Auison, De Gagnon, Alex Crikis, G. Goldsmith, J. Torresan, John Turner. Front row, L. to R.: Fred Guyatt, John Summers, Ian Hale, Graham Guy, Robert Buchan, Denis Vogt.

# —PORT— —AUGUSTA— —GUN— —CLUB—

## BIRTHDAY SHOOT

### Saturday 25th November

at 2 p.m.

- |         |   |            |
|---------|---|------------|
| Event 1 | 50 TGT SKEET<br>PORT AUGUSTA C'SHIP<br>Clarksons Trophy                         | Nom \$8.50 |
| Event 2 | 30 TGT STATE NIGHT<br>CONT. CHAMPIONSHIP<br>Winchester Aust. Trophy.<br>BBQ TEA | Nom \$8.00 |

### Sunday 26th November

at 9.00 a.m.

- |         |   |            |
|---------|---|------------|
| Event 1 | 20 TGT D.T.L.<br>\$100 CASH HANDICAP  | Nom \$6.00 |
| Event 2 | 15 TGT 16 m D.T.L.<br>POINT SCORE<br>750 Cartridges<br>Divided 11-14m, 15-18m, 19-25m,<br>1st & 2nd each group. | Nom \$8.00 |
| Event 3 | 20 TGT 16 m DB<br>D.T.L. PORT AUGUSTA<br>CHAMPIONSHIP<br>Eley Ammunition Trophy                                 | Nom \$6.00 |

OVERALL HIGH GUN  
PRESIDENTS TROPHY  
FRONT MARKER TROPHY  
11-15 metres  
**LUNCH & BBQ TEA**

President:  
M. Mortimer.  
086/422409.

Secretary:  
R. Seaman.  
086/422646.



**A.C.T. INTERNATIONAL, 20-9-78** — Fine, windy (52). 25t Trench EO: B. Scanes 23, G. Baxter 22, B. Smith 22. 50t Trench 1st round of Discount Tyre Service Annual Trophy: 'A' T. Budd (NSW) 45, 'B' B. K. Brown (ACT) 45, 'C' J. Wilson (Downside) 41.

Shooters and their families attended from N.S.W., Hawkesbury, Queanbeyan-Canberra, Berridale, Downside, Dalton-Gunning and Hay gun clubs.

**A.C.T. INTERNATIONAL, 3-9-78** — Cool, occasional showers (23). 10t DB Hcp CD: S. Balogh (Q'byn-Canb), I. Napier (Kerang, Vic) and N. Simms (ACT Int) 10-10. 20t DB Hcp Cash Trophy: J. Napier (Kerang, Vic) and B. Prosser (ACT Int) 25-25 agreed to split 1st place, 3rd M. Prosser (ACT Int) 21-22; FM F. Yates (Q'byn-Canb) 24-25. 25t Sthm Zone Mixed Tgt Ch: 'A' W. Warriner (ACT Int) 22-25, 'B' B. Wellmore (Q'byn-Canb) 20-25, 'C' K. Wellmore (Q'byn-Canb) 23-35; FM L. Notte (ACT Int) 21-35. 20t DB 16m CD: 1st B. Prosser (ACT Int) 20-20, equal 2nd K. Wellmore (Q'byn-Canb), N. Napier (Kerang, Vic), R. Burton (Geraldton, WA), W. Warriner (ACT Int) 19-20. High Gun: B. Prosser (ACT Int) 69-75.

Shooters attended from Queanbeyan-Canberra, Downside, Goulburn Workers, Kerang, Victoria and Geraldton, Western Australia gun clubs.

**A.C.T. INTERNATIONAL, 17-9-78** — Fine, light winds (26). 25t Trench EO: J. Petriella (ACT Int) 25, B. Prosser (ACT Int) and J. Ellis (ACT Int) 23. 50t Burley Griffin Trench Ch: 'A' J. Ellis (ACT Int) 49-50, 'B' B. Scanes (ACT Int) 45-50, 'C' T. Tindal (Berridale) 62-75. 25t Trench OS: V. Abbondante (ACT Int) 25, B. Scanes (ACT Int) 23, P. J. Lee (NSW) and M. Quirk (Sutton Forest) 21.

Shooters attended from Darwin, Berridale, Sutton Forest, New South Wales, Bombala and Queanbeyan-Canberra gun clubs.

## A.C.T. INTERNATIONAL GUN CLUB INC.

All Correspondence to P.O. Box 265, Dickson, A.C.T. 2602  
MAJURA ROAD, CANBERRA

### Saturday November 18th

9.00 a.m. start

Event 1 Nom \$16.00

#### 100 TGT LAKE GINNINDERRA TRENCH CHAMPIONSHIP

In conjunction with A.C.T. Teams eliminations. CASH TROPHIES A, B & C Grades. 50c Optional Sweep each 50 Tgts.

### Sunday November 19th

9 a.m. start

Event 1 Nom \$16.00

#### 100 TGT FEDERAL TRENCH CHAMPIONSHIP

In conjunction with A.C.T. Teams event and Discount Tyre Service Trophy. CASH TROPHIES A, B & C Grades. 50c Optional Sweep each 50 Tgts.

NOMINATIONS \$32.00  
Optional Sweeps \$2.00

Lunch, Refreshments and Cartridges Available on Grounds.

President: N. Simms.  
B/H 41 1211.  
214 Tillyard Drive,  
Fraser, A.C.T. 2615.

Secretary: E. L. Smith.  
A/H 58 4071.  
21 Cooney Court,  
Charnwood, A.C.T. 2615.

**BOTHWELL, 16-9-78** — Mostly fine/overcast (18). 10t DB SS: L. Gray, D. F. Taylor 10-10, M. B. Sinclair, H. Heazlewood, D. Gray 9-10. 25t Mixed Meterage: 'A' A. Styles 21-25, 'B' H. Heazlewood 21-25, 'C' S. Dykstra 29-35; FM R. Sinclair 19-25. 15t DB Hcp: M. B. Sinclair 15-15, R. Cannell 16-17, S. Dykstra 15-17. 10pr DR SS: L. Gray 18-20, D. Gray 16-20, A. Styles and R. Cannell 15-20 divided. High Gun Trophy over events 1 2 3 L. Gray 43-50.

Due to the Football Finals the attendance was reduced. However a good day's shooting was experienced by all that attended.

**BURNIE, 2-9-78** — Fine (72). 50t Hcp: B. Young 57-57, M. Pearn 56-57, M. Hart 53-54; best 11-13 D. W. Barrow 70-72; best 14-16 R. Meikle 49-50; best 17-19 J. Blake 60-61; best 20-25 L. Gray 46-50; best Junior H. Hay 49-50; best Lady Mrs T. L. Nightingale 47-50.

Congratulations must go to Bob Young for his fine shooting and M. Pearn runner-up and 3rd placegetter M. Hart which they shot a 50 break straight to earn themselves break badges, the most unlucky shooter on the day had to be Bob Walker who had a 50 break straight to earn a break badge and still did not win a prize. We also wish Miss Kay Sanders all the best in her quest and we wish to advise that the Charity Shoot raised \$1000 for the day that we presented to Kay.

**CRESSY, 3-9-78** — Fine, windy (56). 15t FM DB Ch 16m 11 12 13m: 11m A. McCarthy 14-15, 12m C. Mitchell 16-17, 13m S. Dykstra 17-17 OA. 20t Central Dist Ch: 'A' J. Blake 23-24, 'B' C. Mitchell & High Gun 24-24; 'C' P. Lowe 29-30. 60t DB Special Ch shot 16m: 'A' L. Viney 71-71, 'B' P. Turner 78-78, 'C' S. Rhodes 68-69.

With weather conditions improving a terrific days shooting was had by all. Congratulations to Laurie Viney on winning the 60t DB "Spring Championship", also Col Mitchell from Berridale, Hobart, on winning 'B' Grade and High Gun on 20t DB "Central District Championship".

**EAST COAST, 26-8-78** — Cold and snowy (21). 10t DB SS: R. Mitchell 10-10, C. Mitchell, D. Cuthbertson, Miss C. Price, A. Bond 9-10. 20t Eastern Dist PS: 'A' G. Richardson 51-60, 'B' & High Gun N. Price 55-60, 'C' C. Mitchell 48-60. 15t Trophy: N. Price, R. Cannell, R. Mitchell.

The shooting team of father and son, Colin and Ricky Mitchell, struck again, with a particularly good display of shooting by Ricky in a shoot-off for 3rd place in the 3rd event. Not a very good day for shooting but our thanks to those shooters who braved the snow and attended.

**HOBART, 12-8-78** — Fine but cold (37). 20t DTL Graded: 'A' T. Pulford 24-24, 'B' C. Calvert 20-20, 'C' M. Blackwell 20-20, 'D' C. Mitchell 23-24. State Night DR Ch: 'A' & High Gun D. R. Taylor 27-30, 'B' G. Smith 25-30, 'C' C. Mitchell 21-30. 10pr DD drawn partners: D. Barrow and B. Bailey 14-14 pairs, 2nd D. Bone and C. Mitchell 13-14 pairs. Novelty event 10t from 16m 10t from 18m: equally divided by G. Rider, M. Blackwell, G. Cleary, R. Walker 18-20 each.

Don Taylor again showed his ability to shoot Double Rise targets. Congratulations Don. Event No. 1 saw some good night shooting in all grades. Congratulations to all Grade winners. DD saw some nearly new shooters to this event, come out on top congratulations to placegetters.

**HOBART, 27-8-78** — Fine (47). 10t FM Event: best 11m T. Weeding 11-11; best 12-13m C. Mitchell 13-13. 25t Graded Skeet: 'A' D. R. Taylor 24-25, 'B' R. V. Conlan 24-25, 'C' L. Martin 23-25, 'D' T. Weeding 25-30. 50t Club Grand Prix Graded: 'A' L. Gray 50-50, 'B' R. Cannell 77-80, 'C' C. Mitchell 52-53, 'D' R. Mitchell 47-50. \$75 Handicap from ACTA Hcps: L. Martin and P. Marshall 20-20 divided, R. Cannell 20-20.

T. Weeding, R. Cannell and father and son combination "The Mitchells" all prominent in this shoot, a definite improvement in all competitors this shoot. Must be the orange targets. Congratulations to all shooters for some very good scores. Nice to see R. V. Conlan back in action again.

**HUONVILLE, 2-9-78** — Fine and mild (32). 10t DB Ch SS Night: F. O'Brien, C. Conlan, D. Wilson, D. Cuthbertson, P. Kelly and G. Richardson 10-10 divided. 4pr DD: R. V. Conlan and Robert Conlan, B. Sidnell and D. Cuthbertson, D. R. Taylor and M. Burgess, G. Cleary and J. Briggs, S. Browning and S. Peacock 4-4pr divided. State DD Night: D. R. Taylor and M. Burgess 19-20, 2nd R. V. Conlan and Robert Conlan 17-20. 10t Hcp SS: B. Sidnell, D. Cuthbertson and D. Wilson 10-10 divided.

This was Huonville Gun Club's first night shoot. We are glad to report that all went well and a good time was had by all. Many thanks to all those who assisted with this latest project.

**MERSEY, 16-9-78** — Fine and cool (49). 1 round Skeet Hcp: I. Rist, G. Atkinson, J. Murphy. 4pr DD SS: 12 pair divided 4-4. Club DD Ch: 1st pr J. Murphy, J. Ellis 36-36, 2nd pr G. Crosswell, R. Elmer 35-36. 10pr DR SS: divided J. Murphy, L. Ellis, R. Elmer 17-20. 25t DB Hcp SS: 1st P. Strickland 25-25; 2nd divided R. Dent, K. Hay, V. Mitchell, R. Gardam, H. Hay, C. Latham, A. Bowering 24-25.

The George Biggs Skeet Shield was strongly contested for between Burnie, North West Field & Game and Mersey Clubs; close scores resulted in a win to Burnie with 116-125, Mersey 115, and Field & Game 114.

**ROSEBERY, 24-9-78** — Fine (41). 5t DB Pts EO SS S. Munday, R. Gardam, G. Appleby, R. Hampton, F. Griffiths, R. Argent, R. Ward, K. Woods 15-15. 20t West D. DB Pts: 'A' R. Hampton 60-60, 'B' C. Latham 52-60, 'C' M. Hart 56-60; High Gun R. Hampton 60-60. 20t DB Hcp: M. Hart 54-55, R. Dawkins 53-55, K. Woods 22-25; best 11m D. Carter 17-20. 15t DB Snapshooting: S. Munday 10-10, R. Hampton 15-16, R. Dawkins 14-16.

An Interclub Shield Shoot was shot between Mersey, Burnie and Rosebery teams, which resulted in a win for Burnie who held the shield last year.

**ROSEBERY, 27-8-78** — Overcast (21). Spr DR EO: K. Woods, R. Argent 9-10, R. Bennion, R. Abblitt, J. Hutcheson, R. Ward, R. Hampton 8-10. 10pr Club DR Ch: 11-12m T. L. Nightingale 12-24, 13-15m T. R. Nightingale 15-20, 16-25m R. Abblitt 17-20. 20t DB Hcp: M. Hart 24-24, R. Bennion Jnr 23-24, R. Abblitt 19-20. 15t Cont Trap: 'A' J. Hutcheson 13-15, 'B' R Argent 20-23, 'C' D. Hay 12-16; best 11m Junior T. Nightingale.

**ST HELENS, 20-8-78** — Fine and windy (26). 15t DB Hcp SS: T. Aulich 15-15; best 11m shooter T. Aulich; best 12m M. Herring. 5t SB EO SS: shared by R. Groves, J. Cashion, J. Blake and B. Bailey 5-5. 20t SB Ch: 'A' A. Styles 19-20, 'B' T. Singline 18-20, 'C' R. Groves 18-20, 'D' M. Skipper 12-20. 20t DB Hcp CD: B. Bailey 20-20, P. Thomas 25-27, A. Tucker 24-27. Annie Oakley (Novelty): won by J. Blake.

High Gun over events 13 & 4 won by B. Bailey.

**SANDFORD, 17-9-78** — Very bad (33). 10t DB Graded SS: 'A' G. Elphinstone, B. Schott, R. Cannell, 'B' B. Sidnell, 'C' T. Richardson, G. Morley, E. Shaw. 20t PS Ch Graded: 'A' A. Kean and High Gun badge, 'B' G. Rider, 'C' J. McFadgen. 15t DB Hcp: R. Cannell and F. Shaw divided 1st 2nd 15-15, G. Elphinstone, A. Kean, G. Price 14-15 divided; best FM P. Kelly.

Very good turn-up for a bad day. The targets were almost impossible to shoot at in some stages. We still saw some very high standards of shooting under the conditions. Allen Kean showed us how by taking out 'A' Grade and High Gun. He is top form at present. Very closely followed by some Front Markers who shot well all day. I must give one of our new shooters J. McFadgen only a few months a member, a mention. Taking out 'C' Grade and his first win in a Championship. Good shooting Mac.

**TASMANIAN, 10-9-78** — Fine with cold winds (72). 15t Pts FM Event: 1st 11m R. Clarke 39-45, 1st 12-13m N. Johnson 44-45. City of L'ton Graded Skeet: 0-1 P. Thurley 32-33, 2-3 L. Toyne 29-31, 4-6 G. Woodberry 25-29, 7+ A. Thurley 15-29. T.G.C. Champion of Champions: 'A' K. Campbell 82-89, 'B' G. Woodberry 100-120, 'C' D. Jurgens 48-58; best 11m M. Webster 35-58; High Gun K. Campbell. 20t DB SS Graded: 'A' K. Campbell 20-20, 'B' H. Kerrison 20-20, 'C' S. Dykstra, Mrs C. Campbell, A. Cunningham al 20-20. High Gun over events 2 3 & 4: J. Murphy 95-103.

Top marksman Ken Campbell returned to his true form with a vengeance in taking out one of our annual classic events in the Champion of Champions. Ken had a good day also winning 'A' Grade in the Double Barrel Sweepstakes. Congratulations on your fine shooting Ken. Good shooting by P. Thurley in taking out his grade of Skeet and his son Andrew took out his grade. Glen Woodberry also had a good day in winning his grade of Skeet and in the Champion of Champions also proved successful in winning his grade. Mrs Campbell completed a successful shoot after a lay-off of some months.

## Charity starts at Burnie

(from Paul Cains)

Burnie's Charity shoot, held on September 2nd was a resounding success. The Club was able to donate \$1,080 to the Miss Tasmania Quest. Seventy competitors turned up, drawn by the excellent prize list, and the looks and charm of the Burnie entrant and club member, Kay Sanders. Also in the beauty stakes, Miss Tasmania, Gerwin Kranenberg also competed and both girls shot exceedingly well for novices. However, Winchester's Wayne Pilkington showed more gallantry than sense in buying both girls in the calcutta. The calcutta, the first held at a Tasmanian shoot, was very well received and the overall winner, Bob Young and his buyer Ian Rist were more than happy with the outcome. The Club was pleased with the running of the event and were delighted with their highest turnout ever. We will hold another Charity shoot later in the New Year in conjunction with the East Burnie Rotary Club.

All in all the day was a great success, a good day for shooters, good promotion for the Burnie Club and last but not least, a substantial sum was raised for the Spastics Association, a very worthy cause. At a time when shooting is not altogether favoured in the public eye, we would commend charity events to clubs throughout Australia, both large and small, as an excellent publicity exercise.

It is with regret we have to report that popular club member, Trevor Buckby, lost his left leg in a road accident. True to form, Trevor is still smiling and is determined to get back to the traps as soon as he is able. We are sure that all shooters would want to join us in wishing him a speedy recovery.



• Kay Sanders, Miss Tasmania entrant.

# HOBART GUN CLUB

## State Championship

AND

## Interstate Teams' Match

### Saturday 11th November

commencing at 9.30 a.m.

Event 1

TASMANIAN I.S.U.  
OLYMPIC TRENCH C'SHIP  
(100 Targets Graded A B C D)  
Trophies each Grade Winner.  
Overall High Gun Sash.

Event 2

TASMANIAN SECTION  
OF THE INTERSTATE I.S.U.  
Olympic Trench Teams Match

Mr G. V. Martin,  
Phone 612720/002.

Mr W. N. Reeve,  
15 Belgrave Street,  
Claremont 7011, Tas.  
Phone 492026/002.

## TASMANIAN GUN CLUB

(in conj with Kings Meadows Rotary - Affiliated ACTA  
"CHARITY DAY")

Sunday, November 12th, 10 a.m.

Event 1 Nom \$4.00

FRONT MARKERS DB EVENT  
Trophy 1st 11m, Trophy 1st 12-13m

Event 2 Nom \$5.50

KINGS MEADOWS ROTARY  
GRADED SKEET  
Trophies each grade — 1 Round Skeet.  
1st 0-1, 2-3, 4-6 & 7+

Event 3 Nom \$4.00

ROTARY SHOOT FOR ROTARIANS ONLY  
10 Target Double Barrel  
Trophies 1st, 2nd & 3rd.

Event 4 Nom \$5.50

MICHAEL BLAKE MEMORIAL C'SHIP  
Graded A, B & C + Best Novice  
Trophies 1st each Grade. Sash each Grade (with compliments Jack and Joan Blake). Compulsory Sweepstake \$1 per shooter (W. Rainbird Nominated Event).

Event 5 Nom \$4.00

ROTARY TEAM SHOOT  
5 Shooters per Team per Club.  
10 Target DB for SKB Shield currently held by Kings Meadows Rotary Club. Winning Team to receive \$100 to be donated to a charity of their choice. Nom

Event 6 Nom \$10.00  
20 TGT DOUBLE BARREL HANDICAP  
Trophies 1st 1900 SKB Shotgun. Trophies 2nd & 3rd.

HIGH GUN OVER EVENTS 2, 4 & 6  
CALCUTTA TO BE RUN ON EVENT 6 - DB HCP.  
Barbecue Luncheon and Afternoon Tea  
available — Refreshments on ground.

Pres: Len Toyne, 160 Elphin Rd., Launceston Tas. Phone: 31 1344; Sec: Neil Coates, 13 Atlas St., Launceston, Tas. Phone: 44 4750. CLINIC: commencing 9.30 a.m. to be conducted by Jack Blake for new shooters including Rotarians.



## WEST AUSTRALIA

**ALBANY, 24-9-78** — Cold, very wet and windy (12). 10t DB 10t SB 10t WU: D. Slee 21-30, M. Bell 20-30, Mrs M. Slee 19-30. 10pr DD: M. Playne and M. Lubcke 16-20, 6 other shooters shared runner-up, they were W. Nottle and K. Holmes, A. MacDonald and M. Bell, D. Slee and Marg. Slee.

The 1st event was held in conjunction with the Max Bell Perpetual Trophy. David Slee held his lead and convincingly won the shield by 8 targets lead. It was the 1st year the shield had been shot for and Max Bell presented it to David. It was good to see 12 shooters compete in the weather conditions which were far from pleasant.

**AZZURRI, 27-8-78** — Fine and sunny (55). 10t DB CD: C. Shephard, S. McSwain, C. Bertini, E. Lewis, N. Mascio, A. Clint, J. Eddy, R. Bailey. Azzurri v Perth Friendship Day Shoot, 20pr DD: P. Vivante, G. Free; 2nd J. Eddy, A. Geddes. 50t DB ACTA Hcp: A. Geddes, C. Forgione, N. Mascio. Team members: Perth - R. Bailey, R. Morris, J. Phillophoff, R. Tomlin, D. Rawlinson; Azzurri - A. Geddes, M. Franklin, C. Forgione, N. Mascio, A. Free.

Congratulations to the Azzurri Team Members on winning the D'Allessandro Friendship Team Trophy. To the Perth shooters there is always next year.

**AZZURRI, 17-8-78** — Fine and cool (33). 50t Skeet Graded: 'A' G. Parkes 48-50, R. Bailey 47-50; 'B' A. Tatasiore 47-50, A. Di Lanzo 46-50; 'C' K. Gipp 45-50, Mrs M. Alexander 46-56.

Well done to all the respective winners in each of the grades.

**EDGEHILL, 15 & 16-7-78** — Overcast, windy, patchy rain (51). Dist Cont Ch 20t: K. Holman 20-20; 1st 'A' K. Holman, 2nd M. Alexander; 'B' B. Mazza, E. Gorrett; 'C' J. Fostinelli, K. Phelan. Cartridge Hcp 25t DB: J. Neve, E. Humphrey, M. Neve; best unplaced 11-14 B. Stockdale, 15-17 W. Jones, 18 & over K. Hopkins. Goldrush Special 100 Cash Graded 20t: 'A' M. Alexander, J. Honey, T. Vodden; 'B' N. Johnson, E. Gorrett, W. Jones; 'C' J. Dowsett, J. Bright, J. Fostinelli. Paddy Hannan Cash PS 20t: B. Stockdale 60-60, C. Bodenham 59-60, D. Ralph 59-60. District SB Ch: 1st O/A E. Gorrett; 1st 'A' M. Alexander, L. Nangle; 'B' E. Gorrett, M. Normington; 'C' J. Fostinelli, M. Callaghan. Gun Hcp 30t: E. Humphrey, J. Neve, L. Nangle.

O/A High Gun N. Johnson, 'A' High Gun K. Holman, 'B' N. Johnson, 'C' B. Stockdale. Competition over carnival very keen, conditions kept entries low, but the Eastern Goldfields Gun Club extends a vote of thanks to visiting shooters.

**EDGEHILL, 16-9-78** — Fine and sunny (52). SW Shield Inter Club Teams Match: High Gun A. Pinner Memorial won by Max Cubic (Collie). A. Pinner Memorial Trophy, all shot in conjunction 50t DB: 'A' Barry Bolitho (Edgehill), 'B' David Proctor (Edgehill), 'C' Grade H. Yates. South West Shield won by Bunbury 270-300 after a shoot-off with Edgehill 270-300. Bunbury's Team - Lloyd Brockman, Grant Hyder, Vince Marney, Bevan Nicholls, Kurt Schinzig, Ross Silvester; Edgehills team - David Proctor, Barry Bolitho, Ted Atkinson, Gary Poller, John Garvey, Kevin Childs.

This was the second year Bunbury and Edgehill drew for the S/W Shield. A shoot-off was also necessary to decide the winner of the High Gun Trophy "A. Pinner Memorial" between Max Cubic (Collie) 47-50 and David Proctor (Edgehill) 47-50. Max being the victor. Shooters participated from Boyup Brook, Collie Bunbury and Edgehill.

**GERALDTON, 13-8-78** — 10t Hcp: R. Baker, I. Richardson, A. Ferreo, W. Johns, R. Hopkins, D. Wellington, V. Bunter 10-10. 15t 16m: R. Baker, A. Filgate, R. Burton, W. Johns, R. Hopkins 15-15. Club DB Ch: 6 shooters scored possibles - A. Ferreo, W. Johns, F. Bombara, S. Zorino, T. Harris and J. Stephenson. After a close shoot-off the Trophy and sash was won by W. Johns 38-38 with A. Ferreo filling second place. High Gun Trophy was ably won by W. Johns 63-63. Most improved trophy went to R. Hopkins 49-50. Intermediate badge was won by F. Bombara 25-25.

**GERALDTON, 3-9-78** — 50t Inter Club DTL. In the first round J. Kevill gained first place with a possible 25, followed by R. Baker, W. Johns, A. Ferreo and D. Kevill on 24. In the second round C. Zorino and R. Hopkins shared the lead each scoring 25-25 with W. Johns, D. Kevill and A. Ferreo scoring 24. The Club Team consisted of R. Hopkins, C. Zorino, A. Ferreo, R. Baker and W. Johns each scoring 47-50 and a total of 235-250. High Gun Trophy was won by J. Kevill 48-50. Most improved went to R. Baker.

Geraldton Gun Club recent ground improvements have been undertaken by the installation of a new Skeet layout using Italian-made "Serena" automatic I.S.U. traps. In the recent Inter Club Skeet Teams Match Geraldton shooters scored a possible 125-125. A Club record was set when 4 shooters in the same squad scored 25-25 possibles.

**KATANNING, 3-9-78** — Overcast and cloudy (27). 50t DB DTL 16m A. Woithe Trophy: The team - Ross Anderson 50-50, Russ Bessen 48-50, S. Gibson 48-50, Rob Bessen 47-50, T. Catling 46-50. 1st Ross Anderson 50, 2nd S. Gibson and Russ Bessen 48-50. Sweep: R. Anderson, Russ Bessen, S. Gibson. High Gun: R. Anderson 50-50.

**KATANNING, 24-9-78** — Warm and windy (24). 25 mixed targets S. Gibson Trophy: 1st Max Hawley 26-25, 2nd A. Woithe and T. Smith 22-25. 10t DR Sweep: T. Smith, P. Garrity, T. Kowald. S. Gibson, Trophy High Gun 11-12-13m: Terry Smith. Visitors Trophy: P. Becker, P. Brook. High Gun: S. Gibson.

**LEONORA, 26 & 27-8-78** — Fine (81). 20t SB Dist Ch: K. Holman 20-20, R. Parker 22-24, J. Honey 21-24. 15t DB Leonora Shire Councillors Hcp ACTA: T. Vodden 42-42, R. Anderson 41-42, R. Mason 38-39. 25t DB Night Comm WU Ch: T. Vodden 21-25, J. Neve 19-25, K. Winter 23-30. 20t DB Shotgun Hcp ACTA: L. Hatley 84-84, V. Bunter 83-84, B. L. Solomon 67-68; meterage 11-14 E. Wierobiej 44-45, 15-18 M. Callarhan 20-21, 19-25 N. Johnson 45-46. 20t DB Com-

# NARROGIN CLAY TARGET CLUB

(INC)

## 10th December, 1978 Sunday 8.30 a.m.

Event 1 Nom \$10.00

20 Targets DB  
Graded A B C  
50% of Noms back to shooters  
in each grade.

Event 2 Nom \$20.00

WINCHESTER  
TOURNAMENT  
16 m 30 Targets DB  
Trophies to 10th place,  
plus 11 to 15 metres  
group, Lady & Junior Shooter  
& Veteran.  
Junior & Ladies \$12.00

TOTAL VALUE \$2122.00

Event 3 Nom \$8.00

20 Targets DB  
Duck Shooters  
Special Handicap  
Trophies to 10th place.

Official Opening  
of our  
New Shooting Complex  
at 3.00 p.m.

Morning and Afternoon Teas  
available

Bring your own Lunch

HIGH GUN

BBQ and Refreshments  
at conclusion of Shoot.

monwealth Tower Ch: J. Neve 29-29, B. Bolitho 28-29, M. Neve 22-23. 20t DB Dist Ch 16m: 'A' T. Vodden 67-67, 'B' B. Mazza 63-64, 'C' K. Lupton 31-32; O/A winner T. Vodden.

Overall High Gun: J. Neve 108-120; runner-up High Gun: N. Johnson 104-120; Inter High Gun: M. Callarhan 104-120; Rogers Shield won by Leonora Gun Club.

This shoot was the first Commonwealth titles shoot held in Leonora and proved to be a very successful weekend. The weather was kind, attendance was good, results spread around between all shooters and trophies appreciated by all those successful. Appreciation must be expressed to the visiting shooters, officials, trophy donors and the ladies who catered for the whole weekend. Visitors commented very favourably on the new club house facilities and indications are that the next title shoot to be held in March 1979 will be an equal success.

#### NEWMAN, DISTRICT CHAMPIONSHIP

Firstly, we would like to thank all the people who took the trouble to answer our invitation, thanks also to Murray and Michelle Alexander and all the members of the Shay Gap Club, who helped to support this shoot.

Day one turned out to be brass monkey weather with a S/E gale, blowing clays everywhere.

Event 1, a coupe by 'C' grade. 1st Bob Pickard - 'C' 16m 30-30 and only possible. Beautiful shooting. 2nd Steve LoPresti - 'C' 14m 29-30. Was selling all his gear and gun, has suddenly changed his mind (wonder why??). 3rd Mike Golden - 'C' 11m 28-30. A new member who is going wild.

Event 2, 20t SB Championship. A fine possible by Dick Day to do Merv McSwain out of first place by one clay. A shoot-off for 3rd by John McKoy, Pete Robson and Murray Alexander. Murray a top gun from Azzurri won out over Pete and John, both top guns from Newman, bad luck fellows.

Saturday night was BBQ night and it was easy to see who wanted to win on Sunday, as most left soon after eating. All those who wanted to kick on finished up at Mervs until around 2 a.m.

Sunday 'mourning' 7 a.m. there was no wind and the sun was shining. By 9 a.m. the time to shoot, the weather conditions were the same as Saturday.

Event 3, Newman District Championship. 1st 'A' grade (and overall) Murray Alexander, who scored a beautiful 30-30. 1st 'B' grade Pete Robson 29-30, shot beautifully and missed one (nerves). 1st 'C' grade a shoot-off between Merv McSwain (Newman) and Greg Gambol (Shay Gap) unfortunately for Greg he dropped the 5th target. Bad luck Shay Gap.

Event 4, 20t DB Points 18m: 1st Tony Stingel 58 points out shot Steve LoPresti (58 points) by one point in a shoot-off for 1st and 2nd. Dick Day and Merv McSwain both on 57 had a short shoot-off for third. Merv dropped his third target.

High Gun was won by Dick Day with 91-100. Merv McSwain missed his last target 90-100 to have a chance to shoot it off, bad luck Merv, who also missed his 50 break (but sure to be trying at Northam).

Best Lady or Junior Shooter was won by Mrs Murray Alexander 82-100, fine shooting Michelle, hope you visit again.

All in all a great weekend, helped tremendously by the ladies, who always had something hot to eat or drink for the shooters, over the two days and nights. Thank you very much girls.

Thanks must also go to the YMCA who provided trappers for the two days which saved us a lot of hassles, thanks boys.

**NORTHAM & DISTRICTS** — Fine (20). Club Champion of Champions. David Kevill won the title after a real "cliff hanger" shoot-off with Mike Callaghan. both were even until the last target which Mike missed, placing the pressure on David who managed a small clip with his second barrel. But as they say "chips win championships." Jim Morgan won the handicap section followed by Barry Bristow-Stagg and David Kevill, while Tod Harris, John Kevill and Bruce Smart were placed equal 4th. Robert Herridge leads the aggregate handicap competition with 15.3 points followed by Bob Thomson and Merv Madew. The Aggregate High Gun Competition has had a real shake up, Roy Holtfreter leading with 22 points, David Kevill has now moved into second place with 17 points then comes Robert Herridge with 15.5.

**PERTH, 9 & 10-9-78** — Cold, very wet and windy (80). 10t Cont DB 18m CD: A. Charleson, M. Callaghan, R. Bailey, C. Bertini, P. Charsley, all 10-10. 30t State Cont. DB 18m Graded: 'A' K. Holman 30-30, M. Alexander 33-36; 'B' G. Hayward 29-30, G. Holly 28-30; 'C' C. Hyder 27-30, A. Charleson 25-30. 30t Winchester Tournament DB 16m: W. Kennamer 30, G. Hayward, G. Hyder, A. Geddes, T. Vodden, D. Wisse 29, M. Alexander, C. Hinkley, D. Lithgow, R. Bailey 28; 11-15m M. Neve 28; Lady C. Ireland 25, Junior A. Charleson 26, Veteran J. Philippoff 25. 25t Koojan Hcp: O. Makkonen 25 (Mazzucchelli Trophy), C. Bertini, K. Schinzig, C. Chiarle, M. Neve, C. Hyder, B. Humphrey 24. 25t City of Perth Skeet Ch: K. Childs 42-42, K. Holman 40-42, R. Bailey 38-40; donated by F. C. Lovelock and Co. 50t State Skeet Ch: R. Bailey 50-50, D. Henthorn 62-64, G. Hyder 61-64; donated by Boustead P/L. 25t Perth Air Fare Hcp: : N. Hyder 32-33 donated by T.A.A., D. Knight 31-33 donated by T. Holt, R. Alexander 24-25. Overall High Gun: K. Holman 184-195.

**WAGIN, 12-9-78** — Cold, very wet (19). Club DB Ch: P. Becker 47-50, C. Ball (Kojunup) 49-50, T. Smith 45-50, G. Smith 43-50, Mrs N. Ball 43-50, J. Clegg 40-50, C. Holly 41-50, K. Smith 35-50, I. Fillgee 36-50, M. Paget 18-50, P. Quartermaine 37-50, D. Davis 33-50, R. Pederick 37-50, R. Bolt 39-50, A. Jackson 39-50, M. Divall 26-50, M. Mitchell 33-50, M. King 18-50, D. Medlin —.

Bad weather held up shooting for a while, but persistent rain continued and shooters all experienced wet weather shooting. Scoring was fairly good under the circumstances but those shooters wearing glasses were severely handicapped. Trophies to C. Bull, P. Becher and T. Smith. Shooting from new club site. Club house will be built by next shoot.



## NORTHERN TERRITORY

**ARNHEM, 9-9-78** — Calm (7). EY EO Jackpot: H. Meier 14. 15t DB Hcp: P. Whatley 14, D. Stevens 13, E. Rankin 12. 10pr DR Novelty: E. Rankin 15, P. Whatley 12, D. Stevens 9-9. 10pr DD: D. Stevens and E. Rankin.

**ARNHEM, 24-9-78** — Hot (6). 15t SB: E. Rankin. 10t W-U: P. Whatley, E. Rankin, A. Smith. 25t Skeet: E. Lampe 20, D. Stevens 19, E. Rankin 18.

**KATHERINE, 3-9-78** — Hot and humid (12). 20t DB Hcp Perpetual Trophy: R. Johnston. 15t DB Pts 16m: R. Henley, E. Rayner, I. Winstanley. 5t WU: E. Rayner, I. Winstanley.

**McARTHUR RIVER, 2 & 3-9-78** — Hot, fine and windy (18). 5t EO DB 5S: 8 possibles 5-5 W. Caple, Dianne Moseley, G. Cooke, L. Wilcocks, W. Onton, N. Kuskopf, K. Foord, T. Kittila. 20t DB Pts off hcp (Patrons Trophy): D. Clement, 2nd 2 possibles N. Kuskopf and K. Foord 56-60; after shoot-off 2nd N. Kuskopf 68-72, 3rd K. Ford 65-69. Teams Event 10t DB 16m: Mt Isa 137, McArthur 108, Mixed Team 100. DR Ch 10pr 16m: A. Burchler, 2nd 2 possibles T. Kittila, L. Wilcocks 15-20; after shoot-off 2nd T. Kittila 17-22, 3rd L. Wilcocks 16-22. Mirmets Trophy 20t DB off hcp: 2 possibles K. Foord, G. Cooke 20-20; after shoot-off 1st K. Ford 24-24, G. Cooke 23-24; 3 possibles 3rd D. Ward, P. Kennett, W. Buchanan 19-20; after shoot-off 3rd D. Ward 23-24. SB Ch 20t 16m: 1st 2 possibles T. Kittila, W. Buchanan 20-20; after shoot-off 1st T. Kittila 22-23, 2nd W. Buchanan 21-22, 3rd L. Wilcocks 17-20. Calcutta 30t DB off Hcp: P. Kennett 29-30.

Best 11m shooter D. Moseley 25-30; best 12-14m J. Janecek, W. Buchanan 28-30; best 15-16m W. Onton 28-30; best 17-19m L. Wilcocks 28-30; best 21m A. Buerchlor 27-30; mens High Gun T. Kittila 112-125; Ladies High Gun D. Moseley 94-125.

Special thanks to the nine Mt Isa shooters who made our weekend a great success. With only 18 shooters, the final pool for the Calcutta was \$1315, which was won by K. McCall.

# KATHERINE GUN CLUB

## ANNUAL XMAS SHOOT

**SUNDAY 3rd DECEMBER**  
8.00 a.m. start

Northern Territory  
State Tower Title

Northern Territory  
State Walk-Up Title

Novelty Events time permitting.

Camping facilities  
available at Club Grounds.

Sec.: I. Winstanley,  
P.O. Box 1128,  
Katherine.  
Phone: 42 1660.

Pres.: E. Rainer,  
Ballongilly,  
Katherine.  
Phone: 72 1428.



# VICTORIA

**ALEXANDRA, 2-9-78**—Beautiful (74). 10t DB 16m EO: shared by J. Farley, D. Bordan, P. McNair, J. King, R. Lambden, J. Maxwell, P. Nash, N. Frankling, P. Taylor, J. Woolmer, J. Blakeney, R. Nicolson, B. Hall, J. Blackley, T. Apps, R. Elward, J. Whittakers, W. Newton, J. Powell. 20t DB "Old Trout Opening" Ch: J. Whittakers 219-219, J. Blackley 218-219, A. Sheard 85-86; FM R. Craker 16-20; Tyro Sash - T. Hobson 28-29. 10t DB Trophy Hcp: T. Hobson 40-40, J. King 39-40, R. Young 22-23; BM G. Willet 20-21. 30t SB Vic State Night Ch: OA John Whittakers 29-30, 'A' J. Whittakers 29-30, G. Willet 28-31; 'B' B. Pyke 28-30, N. Frankling 26-30; 'C' A. Hall 28-32, G. Lee 27-32. 30t SB Vic Stat Night Ladies Ch: A. Hall 26-30, J. Grice 25-30. 15t DB Cash Hcp: J. Blackley 34-34, C. Whyte 33-34, K. Elward 32-33.

A fantastic crowd turned out to see John Whittakers take off our annual "Old Trout Opening", after a mammoth shoot-off to 219. John Whittakers also won the State Night SB C'ship. Alison Hall won the Ladies Division.

**APSLEY, 10-9-78** — Fine (50). Kowree & Border Dist DD Ch: E. Hall and T. Scott 19-21, R. Morris and P. Cleggett Jnr. 18-21. \$100 Hcp: P. Cleggett Jnr 31-31, H. Vaughan 30-31, T. Zbierski 28-29. 10t Hcp & 5pr DR: J. Groves and P. Cleggett Jnr divided 1st 18-20, I. Bell and R. Morris divided 3rd.

Shooters found the targets in DD event very evasive, but good scores registered in Handicap events. Nice to see the visitors in E. Hall and Terry Scott have a win and congratulations to the ever popular Harry Vaughn from Hamilton to take back a trophy.

**ARARAT, 27-8-78** — Calm and cold (38). DB Ch: K. Wright (Skipton), G. Leslie (Ararat), D. Crouch (Ararat). 15t Novelty: 5 equal trophies J. Kerr, G. Leslie, J. Dignan, D. Crouch, G. Pitcher. 10t Sweepstake: divided G. Young, R. Garlick, J. Kerr, D. Crouch, G. Coburn, R. Scott, J. Dignan.

**BAIRNSDALE, 2-9-78** — Fine (40). 10t DB Pts EO: B. Hall, N. Elliott 30-30, A. Bremner, D. Missen, N. Smart, D. Zema 29-30. 40t DB Legacy Charity Ch: B. Hall 40-40, A. Bremner 50-51, M. Hamilton 49-51; 11-14m M. Howard 44-45, 15-19m L. Curtis 88-89, 20-25m D. Missen 37-40. 20t Yardage Hcp: 11-14m D. Camin 29-29, R. Gordon 28-29; 15-19m L. Curtis 26-26, W. Growcott 25-26; 20-25m B. Hall 19-20, C. Ellis 18-20. Overall High Gun: B. Hall 69-70. Cake Shoot: J. Aukema.

This shoot was our Annual Legacy Charity Shoot and approximately \$600 was raised on the day for this very worthy cause. Congratulations to Bruce Hall, Champion on the day.

**BANDIANA AREA ARMY, 24-9-78** — Fine and calm, perfect (32). 3pr DR EO: 2 possibles Kevin Wilson and Graeme Ridgeway. 12pr DD Ch: Julian

## CORIO BAY GUN CLUB, GEELONG

Friend In Hand Rd (off Hamilton H'way)

### Saturday 11th November

commencing 1 p.m.

- |                           |   |            |
|---------------------------|---|------------|
| Event 1                   | 10 TGT E/O HANDICAP<br>PTS C.D.   | Nom \$2.50 |
| Event 2                   | 20 TGT HANDICAP<br>1st \$60, 2nd \$30, 3rd \$10; BM 22-25m \$10; Juniors trophies 1st & 2nd Noms \$1.50.  | Nom \$6.00 |
| Event 3                   | 20 TGT PTS CHAMPIONSHIP<br>Sash & Trophy 1st, Trophies 2nd & 3rd; Junior noms \$1.50; Trophies 1st & 2nd. | Nom \$5.00 |
| Event 4 (time permitting) | 10 TGT DB CASH DIVIDE   | Nom \$3.50 |

**PLEASE NOTE** all shooters must produce current registration cards. **REMINDER:** Novice Championship conducted on the 4th Thursday of each month at 6.30 p.m.; also the 4th Saturday of each month along with the Club Members Championship at 1.00 p.m.

Pres.: Gordon Tarbett.  
Phone 78 1526.

Sec.: Ken George,  
72 Newton Ave., Nth Geelong. 3215.  
Phone 78 2827.

## MILDURA CLAY TARGET GUN CLUB

(Affiliated A.C.T.A.)

**Friday, Saturday, Sunday  
17th, 18th, 19th November**

**FRIDAY 17th**  
commencing at 10 a.m.

Event 1 Nom \$10.00

MILDARA WINES  
UNIVERSAL TRENCH C'SHIP  
50 targets Graded A-A A B C

Friday Night commencing at 7.30 p.m.

Event 2 Nom \$6.00

MILDARA WINES  
P/S NIGHT C'SHIP  
20 targets off 16 m

**SATURDAY**  
commencing at 10 a.m.

Event 3 Nom \$17.00

VICTORIAN UNIVERSAL  
TRENCH CHAMPIONSHIP  
100 targets. Graded A-A A B C

Event 4 Nom \$6.00

MILDARA WINES  
SKEET CHAMPIONSHIP  
25 targets

1st Sash & Trophy, 2nd & 3rd Trophy. Best 4-10 Trophy.

Saturday Night, commencing at 7.30 p.m.

Event 5 Nom \$6.00

TROPHY SHOOT  
10 targets off Handicap

Event 6 Nom \$6.00

MILDARA WINES  
DB NIGHT C'SHIP  
20 targets DB off 16 m  
Graded A B C

**SUNDAY**  
commencing at 10 a.m.

Event 7 Nom \$5.00

TROPHY SHOOT OFF HCP  
20 targets off Handicap  
1st, 2nd & 3rd Trophy.

Event 8 Nom \$6.00

MILDARA WINES  
DB CHAMPIONSHIP  
20 targets off 16 m  
Graded A B C.  
1st Sash & Trophy, Trophy each Grade.

Hon. Sec.: Laurie Connors,  
P.O. Box 19, Mildura 3500.  
Phone 23 2567.

# VICTORIAN STATE COACHING SEMINAR

★ — ALL WELCOME — ★

## FRANKSTON-AUSTRALIAN GUN CLUB Saturday November 18th

The Victorian Coaching Council  
will conduct an  
“ALL DAY SEMINAR”  
commencing at 10.00 a.m.

Morning Session in Club House

Welcome and Introductions.  
State Director and Zone Coaches.

- ★ Explanation of our objectives.
- ★ The Fundamentals of Clay Target Shooting.
- ★ Talk on the Gun, and the part it plays in our sport of Clay Target Shooting.
- ★ The importance of proper Gun fit.
- ★ Proper Stance and correct Gun holding.
- ★ How we should obtain correct lead, etc.
- ★ Where to hold on the trap house.
- ★ QUESTIONS AND ANSWERS.

12 o'clock lunch.

AFTERNOON:—

- ★ Practical Shooting Activities on the Shooting Ground —  
Skeet and Trap under instruction.  
(Slides also . . . time permitting)
- ★ Olimpyc Targets have donated clay targets for the day.

Sec.: R. Learmonth.  
Phone B/H 5440666 ex 127.

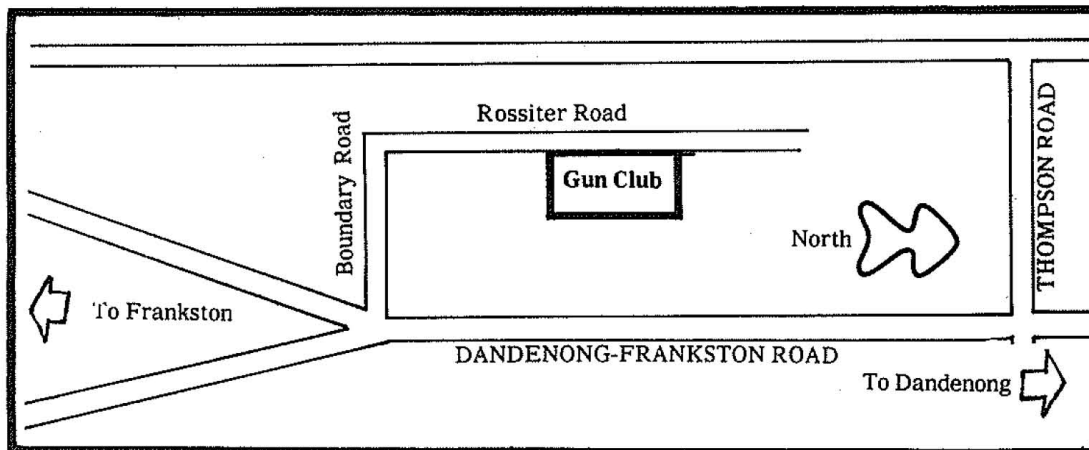



# WINCHESTER TOURNAMENT 1978-79

## ARARAT GUN CLUB SUNDAY 26th NOVEMBER

Event 1

As an Eye Opener to the  
Winchester Tournament

**20 TARGET  
PRESTIGE HOLEPROOF  
POINTS SCORE  
CHAMPIONSHIP**  
start 9.30 a.m.

Event 2

**THE  
WINCHESTER  
TOURNAMENT**  
D.B. 16 METRES,  
30 TARGETS

**Prizes:**

- 1st:** GSX1031 Super X Model Skeet Gun Plus Location Winner Sash, Badge & Cap. Value \$500.  
**2nd:** Little Big Horn 44/40 Commemorative Rifle and Cap. Value \$304.  
**3rd:** G140085 1400 Automatic Shotgun W/VR Winchokes and Cap. Value \$274.  
**4th:** G9412 Lever Action 30/30 Carbine and Cap. Value \$184.  
**5th:** MEC 600 Junior Reloading Press and Cap. Value \$134.

**Places 6, 7, 8, 9 and 10** - 1,000 Primers, 1000 Wads and Cap. Value \$45

**11-15 Metre Group** - G 140085 Plus Cap and Badge. Value \$277.

**Lady Shooter** - Silver Salver plus Badge and Cap. Value \$78.

**Junior Shooter** - Under age 16 at time of shoot. Silver Salver plus Badge and Cap. Value \$78.

**Veteran Shooter** - Age 60 or over at time of Shoot. Silver Salver plus Badge and Cap. Value \$78.

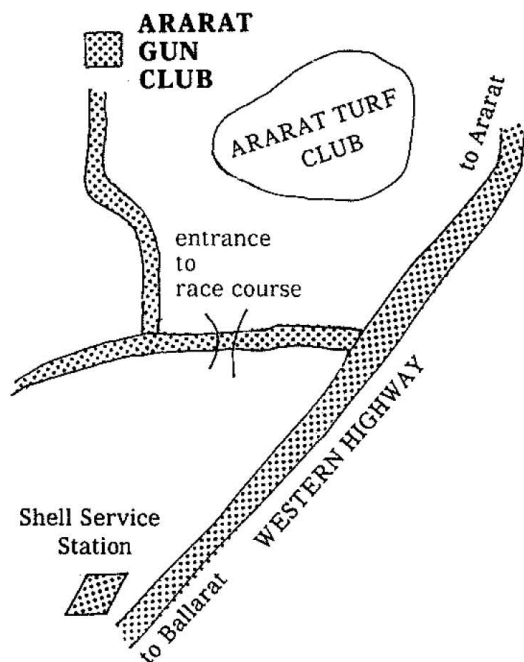

Refreshments, Luncheon,  
Cartridges available on Grounds.

Secretary: Rod Liesfield,  
1 Commercial Street, Willaura 3291.  
Phone 53 1459.



# METROPOLITAN CLAY TARGET CLUB

O'HERNS ROAD  
EPPING.  
Turn West off Epping  
Road at Cemetery.  
Club 3 kms on right.

## NOVEMBER PROGRAM



### Saturday 4th, Sunday 5th, Monday 6th and Tuesday 7th 30th METROPOLITAN GRAND PRIX CARNIVAL

For details refer October "Shooting News"

#### Saturday 11th

Practice and Novice Championships

#### SATURDAY NIGHT 11th . . . 7.30 start

DIAMOND CREEK TWILIGHT AUTO & DRIVEN C'SHIP	\$5.00
DIAMOND CREEK DOUBLE BARREL	\$5.50
DIAMOND CREEK DOUBLE RISE	\$5.50

#### SATURDAY 18th . . . 12.30 start

SECRETARY'S 50 TGT D/B MARATHON	\$9.00
A B C — American Style	
SECRETARY'S SINGLE BARREL CHAMPIONSHIP	\$6.50
Open and Intermediate	
SECRETARY'S SKEET CHAMPIONSHIP	\$6.00
A B C	

#### SATURDAY 25th

Practice & Novice Championships

#### SATURDAY NIGHT 25th . . . 7.30 start

15 TGT TWILIGHT HANDICAP TROPHY	\$5.00
TULLAMARINE D.B. CHAMPIONSHIP Open and Inter.	\$5.50
TULLAMARINE S.B. CHAMPIONSHIP	\$5.50
HANDICAP (Time Permitting)	
TULLAMARINE SKEET CHAMPIONSHIP	\$6.00

Practice every TUESDAY AFTERNOON from 12.30

PRESIDENT:  
R. Shipperlee.  
Phone 370 3331.

SECRETARY:  
L. Hubbard,  
12 Manus Court,  
Lalor.  
Phone: 465 1216.

# FRANKSTON-AUSTRALIAN GUN CLUB

ROSSITER ROAD, CARRUM DOWNS.

President: Gordon Morgan  
Phone (Bus) 932366  
Priv. 7929057.



Secretary: R. G. Learmonth  
36 Petronella Ave.  
Wheelers Hill  
Phone 5612484.

## “SPECIAL BIRTHDAY ANNIVERSARY SHOOT”

TO COMMEMORATE TURNING THE FIRST SOD.

### SATURDAY 11th NOVEMBER

commencing 12 noon sharp

## \$1700 WORTH OF TROPHIES 17 SASHES TO BE WON

Event 1	10 TGT FRANKSTON-AUSTRALIAN GRADED POINTS CHAMPIONSHIP Full Sash and Trophy for Overall winner. Ribbon & Trophy for Grade winners. Trophy for 2nd in each Grade.	Nom \$3.50
Event 2	15 TGT FRANKSTON-AUSTRALIAN DB CHAMPIONSHIP Sash and “AUTOMATIC SHOTGUN” for first in each Grade. Excellent Trophies for 2nd in each Grade (Grades A B & C).	Nom \$15.00
Event 3	10 TGT FRANKSTON-AUSTRALIAN GROUP YARDAGE CHAMPIONSHIP Sash & Trophy for first in each Group. Trophy for 2nd in each Group. <b>8 GROUPS</b> 11m 12-13m 14-15m 16-17m 18-19m 20-21m 22-23m 24-25m	Nom \$5.00
Event 4	10 TGT FRANKSTON-AUSTRALIAN S/B CHAMPIONSHIP (A B & C Grades) Full Sash and Trophy for overall winner. Ribbon and Trophy for Grade winners. Trophy for 2nd in each grade.	Nom \$3.50

Cartridges etc. available.

Usual Full Canteen Facilities Available from 11.30 a.m.

### “BIRTHDAY BARBECUE SOCIAL EVENING”

All Food, Steaks, etc., available at the ground — BYO Refreshments.

Sojkoski and Brian Bockman 23-23, Danny Cirsky and Graeme Day 22-23, Max Fuge and Graeme Fuge 16-17. 15t SB Hcp: Peter Morgan 22-22, Graeme Day 21-22, Max Fuge 21-22, Kevin Wilson 20-22; best 20-25m Brian Bockman 13-17; best Novice Peter Draper 12-15. 10t DB Hcp CD: 9 possibles.

A very good afternoon of social shooting. Congratulations to Julian and "Bocky" on their third Deauville Doubles Championship win in two weeks.

**BENDIGO, 16-9-78** — Good (43). Club DB Night Ch: 'A' C. Knight 48-49, R. Lehman 47-49; 'B' N. Napier 24-24 & OA, B. Santon 23-24; 'C' L. Knight 23-24, M. Davis 29-30. 15t Hcp: L. Knight 21-21, I. Napier 20-21, L. Roberts 16-17; BM 20-25m N. Frankling 18-19

Bendigo Club's September Night Shoot saw 43 shooters compete in good weather conditions but results were generally poor. Only four possibles in the DB Championship with 19-20. Best scores in 'A' grade. The Handicap also only saw three possibles with short shoot-offs the order of the night.

**BIRCHIP: 2-9-78** — Sunny, windy (35). Birchip Club PD DB Day Ch: 'A' S. Kerr (Kerang) OA 58-60, J. Witney (W'beal) 57-60; 'B' R. Ferrier (Birchip) 56-60, J. Dunstan (Kerang) 52-60; 'C' G. Kerr (Kerang) 56-60, C. Reid (Kerang) 55-60. \$150 Cash Hcp: 3 divided R. Young (Stawell), Brian Pitt (Jeparit), Les Saunders (Boort) 15-15.

Handicap adjustment: G. Kerr (Kerang) from 14m to 15m, Russ Young (Stawell) from 17m to 18m, Brian Pitt (Jeparit) from 12m to 13m, Les Saunders (Boort) from 12m to 13m.

**BOORT, 4-9-78** — Fine (40). 10t EO: 13 shooters shot possible and divided K. Burton, I. Smith, B. James, B. Billing, J. Allison, P. Harper, C. Penno, B. Knight, R. Fowler, F. James, M. Newell, N. Napier, G. Lallis. 20t DB Graded Ch: 'A' R. Fowler 20-20, 'B' P. Parsons, 'C' A. Turner. 10t Hcp: 8 shooters shot possible R. Saunders, B. Ridgway, J. Allison, P. Harper, C. Penno, B. Knight, I. Napier, O. Allison.

**BOORT, 5-9-78** — Fine (26). 10t EO: 4 shot possible B. James, P. Lassone, J. Allison, K. Edwards. 15t Trophy Hcp: B. James 36-36, B. Billing 35-36, R. Saunders 18-19. 5pr DR SS: B. Billing, N. Featherby, R. Saunders, I. Smith divided. 15t Novelty 12-16-18m: B. James, J. Allison.

**CALLAWADDA, 19-8-78** — Mild and fine (40). 20t Trophy Hcp: P. Scott 27-27 (Callawadda), A. Castle 30-31 (Stawell), L. Dowsett 29-31 (Callawadda); FM J. Taylor 23-24. 15t Cash Hcp: 5 divided J. Taylor, C. Dooley, L. Kemp, P. Scott, S. Hemley 30-30.

**CALLAWADDA, 10-9-78** — Fine and warm (36). Spastic Children's Appeal DB Ch: OA L. Dowsett, 'A' R. Newell, C. Dunn; 'B' P. Scott, R. Gould; 'C' K. Willey, C. Fielding. Sthrn Wimmera DB Mini Tgt Ch: OA P. Scott, 'A' L. Gibson, R. Newell; 'B' R. Gould, G. Hirst; 'C' S. Hemley, M. Martin. Cash Hcp: 4 divided M. Martin, G. Hirst, G. Leslie, P. Pendlebury.

Thanks to our usual good supporters. We made a \$90 donation to the local Miss Australia Quest entrant, even though the overall attendance was down. The club thanks Ron Newell for donating his trophies back to the Appeal.

**CALLAWADDA, 16-9-78** — Overcast and mild (31). DB Ch Club: OA L. Gibson 34-34, 'A' R. Newell 26-27, L. Johnston 19-20; 'B' C. Fielding 26-27, R.

**CALLAWADDA GUN CLUB  
CORRECTION TO  
ADVT. THAT  
APPEARED IN  
V.C.T.A. ZONE  
BOOKLET**

**Saturday 18th November**

1.00 p.m.

Event 1

**30 TGT HANDICAP**  
1st OA trophy: portable Color TV  
11-14 15-17 18-20 21-25  
\$50 prize each metre group.

Event 2

**STHRN WIMMERA  
DR CHAMPIONSHIP  
WHICH REPLACES  
15 Target Cash Handicap  
NIGHT EVENT**

**20 TGT MAORIS IDOL DB C'SHIP**

Sec: B. Taylor  
Callawadda.  
Ph: (053) 598210.

Pres: L. Gibson,  
Stawell.  
Ph: (053) 58 2263.

**MORNINGTON  
CLAY TARGET  
CLUB  
November 11th  
100 TARGET  
D.B.  
CHAMPIONSHIP  
GRADED**

**OVERALL WINNER  
SASH & CASE  
OF CARTRIDGES**

- ★ A GRADE WINNER ★  
Ribbon & ½ Case of Cartridges
- ★ B GRADE WINNER ★  
Ribbon & ½ Case of Cartridges
- ★ C GRADE WINNER ★  
Ribbon & ½ Case of Cartridges
- ★ NOVICE ★  
Ribbon & 100 Cartridges
- ★ RUNNER-UP EACH GRADE ★  
Trophies

To Be Shot  
American Style

Noms \$16.00

CATERING

AVAILABLE

CARTRIDGES

**PLUS ONE CASE  
OF CARTRIDGES  
FOR THE FIRST  
100 BREAK SHOT  
AT MORNINGTON**

T. Ferlazzo.  
(059) 75 3145.

G. Matthews  
059 87 1060

Garlick 25-27; 'C' S. Hemley 33-34, K. Willey 20-21. Cash Hcp: 4 divided K. Willey, A. Castle, B. Joy, G. Bollen. DR 10pr: equal 1st R. Young, R. Newell 18-20, 3rd L. Johnston 16-20.

**H.M.A.S. CERBERUS, 2-9-78** — Fine and sunny (35). 10t Pts: C. Carrol 30-30, N. Quick 29-30, L. Coster, P. F. Arnold, P. R. Arnold 26-30. 20t DB: K. Flenjar 34-35, B. Woodward 33-35, G. Ash 22-24. 10t Cerberus Circles: C. Carrol 27-30, Rex Peacock 26-30, P. F. Arnold 25-30. 10t Hcp: C. Chandler 23-23, P. F. Arnold 22-23, M. Charlsworth 14-15.

The new dayglow targets were a help to Keith Flenjar in winning the main event and almost gave Rex Peacock a win first time up in the Cerberus Circles.

**COHUNA, 8-9-78** — Fine, cool (60). Novice: B. Chatham 14-15, L. Christie 13-15. 10t EO: M. Napier, B. Reade, C. Doyle, J. Saville, S. Kerr, J. Allison, O. Allison, L. Saunders, R. Saunders, L. Bernard, R. Allen, G. Norris, J. Kerr, L. Knight shot possibles and divided cash. Cohuna Club DB Ch: G. Norris 31-31, B. Reade 30-31, C. Knight 28-29; FM B. James 27-27, J. S. Baker Hcp: R. Saunders 27-27, N. Napier 26-27, G. Kerr 27-28; FM A. Stevens 26-28. Off Fence: R. Fowler.

**COHUNA, 22-9-78** — Overcast, cold (51). Novice: M. Forbes 10-10, K. Crichton 8-10. 10t EO: N. Napier and C. Knight shared Sweeps. Cohuna Club DR Ch: M. Newell 18-20, J. Kerr 20-24, N. Napier 19-24; FM J. Allison 15-20. MacKenzie & MacKenzie Trophy Hcp: J. Allison 44-44, L. Knight 43-44, R. Marchioni 35-38; FM O. Allison 21-22. Off Fence: B. Fowler.

**COLAC, 1-7-78** — Perfect. EO 6prs DB: H. Squires, C. Kneebone 10-12, H. Eldridge, D. Lestrangle, I. Dickins 9-12. Club DR Ch: O.A. F. Dignan 17-20, 'A' I. Dickins 16-20, 'B' F. Dignan 17-20, 'C' P. Blick 15-20.

**COLAC, 5-8-78** — Fine but overcast. EO 10t: H. Edwards, O. Martelli, M. Tarbett, R. Parker, H. Eldridge 30-30. Club DB Ch: 'A' H. Eldridge 20-20, A. Allitt 20-20; 'B' R. Light 19-20, W. Robertson 19-20; 'C' D. Bramley 20-20, P. Blick 19-20.

**COLAC, 12-8-78** — Horrible. 50t Lake Colac Trench Ch: highest score R. Parker 47-50, 'AA' R. Parker 47-50, H. Eldridge 45-50; 'A' D. Milojevic 41-50, G. Ludbrook 39-50; 'B' A. Allitt 41-50, R. Mark 39-50; 'C' D. Gaylard 38-50, I. Knox 36-50.

**COLAC, 2-9-78** — Perfect. EO 10t: F. Dignan, R. Parker, M. Howell 30-30. DD Ch: I. Dickins and P. Torok 25-25, H. Eldridge and A. Allitt 24-25.

The Club will again shoot trench on the second Sunday of each month and not second Saturday as has been for the last couple of months. Watch out for details of our South Western Zone Shoot to be held in November.

**CORIO BAY, 9-9-78** — Perfect (45). 10t EO Pts: R. Morrison, K. Whelan, P. Edmondson, W. Callaby, T. Nash all 30-30. 50t DB Ch: R. Evans 57-57, R. Parker 56-57, H. Eldridge 57-58, K. Whelan 56-58; 11-15m group M. Kingwell 47-50, J. Manser 46-50; 16-20m group C. Allitt 64-66, M. Hewitt 63-66; 21-25m group N. Paterson 48-50, B. Cartledge 59-62; Junior event: C. Vandenberg 47-50. 10t CD: P. Edmondson, C. Nolt, J. Braybon, R. Schwarz all 10-10.

The Club's policy of encouraging Junior shooters is starting to show results with some of the Juniors outshooting the adults as in the club's 50 target Champion. In this event Juniors Chris Vandenberg shot 47-50 and Mark Tarbett shot 46-50. Two good scores which most of the adults would have been happy to have shot.

**D.M.H.S. & COMMUNITY, 16-9-78** — Fine, westerly wind (34). Desert Festival DB Ch: 'B' & OA N. Block (Goroke) 35-35, W. Merrett (Horsham) 34-35; 'A' K. Burton (Kerang) 24-26, N. McDonald (Dimboola) 23-26; 'C' S. Joseph (Jeparit) 19-20, P. Pendlebury 18-20; Juniors: S. Hounsell (Jeparit) 17-20; Ladies: E. Pitt (Jeparit) 12-20. Winchester Trophy: 11-15m J. Taylor 29-29, 16-19m N. McDonald 26-27, 20-25m K. Burton 16-18. Off The Box: Tod Wallace (Dimboola).

**DONALD, 2-9-78** — Calm, warm (25). Club DB Pts Graded Ch: OA C. Knight (Bendigo) 60-63, 'A' C. Dunn (Donald) 59-63, 'B' J. Clark (Warracknabeal) 56-60, 'C' B. Lewis (Boort) 51-60.

Donald Gun Club wishes to thank those who attended and apologise for the trap breakdown which caused other events to be cancelled.

**ECHUCA, 9-9-78** — Fine, cool and cloudy (70). N-E Zone DB Ch (Day): R. McKenzie 43-43, R. Glenn 42-43, W. Wickham 34-35; FM S. Atkins 20-21. 20t Hcp (Day): 11-15m L. Bernard 28-28, S. Atkins 27-28; 16-20m J. Rist 22-22, L. Gibson 21-22; 21-25m K. Bucholtz 20-20, R. Allen 25-26. NE Zone DD Ch (Night): L. Brown, W. Coulson 41-41, 2nd R. Allen, K. Bucholtz 40-41. Echuca G.C. DR Ch (Night): R. Piastrri 20-22, R. Glenn 19-22, F. James 18-22.

A fair crowd was in attendance. There was good competition in the DB Championship with Ray McKenzie of Echuca winning from Ron Glenn. The



Cnr. Geelong & Little Boundary Roads,  
Brooklin.

## NOVEMBER 1978 PROGRAM COMMENCEMENT OF TWILIGHT SHOOT

### WEDNESDAY 1st

commencing 7 p.m.

- 15 TGT S/B C'SHIP (Twilight) Nom \$4
- 15 TGT D/B HANDICAP Nom \$4

### SATURDAY 4th

commencing 1 p.m.

- 20 TGT D/B C'SHIP Nom \$5
- 20 TGT D/B HANDICAP Nom \$5

### WEDNESDAY 8th

commencing 7 p.m.

- 15 TGT TOWER PTS (Twilight) Nom \$4
- 15 TGT D/B C'SHIP Nom \$4

### WEDNESDAY 15th

commencing 7 p.m.

- 16 TGT D/R C'SHIP (Twilight) Nom \$4
- 16 PR DD C'SHIP, drawn Nom \$4

### WEDNESDAY 22nd

commencing 7 p.m.

- 15 TGT PTS HCP (Twilight) Nom \$4
- 15 TGT D/B C'SHIP Nom \$4

### WEDNESDAY 29th

commencing 7 p.m.

- 15 TGT D/B MINI PTS C'SHIP (T'light) Nom \$4
- 16 PR DD MINIS 20m Nom \$4

**PROGRAM TO BE ALTERED  
AT COMMITTEE'S DISCRETION  
NOMS FOR 1ST EVENT CLOSE AT 8 P.M.**

No Nominations will be accepted from shooters who are unable to produce a current A.C.T.A. Registration Card. Excellent Canteen Facilities at All Shoots.

SECRETARY:  
M. Shiels,  
17 Finley Rd, Altona 3018.  
Phone: Bus 741 1998;  
AH: 398 1944.

PRESIDENT:  
V. Mollica,  
Roberts Street,  
East Keilor.

## MANSFIELD GUN CLUB

SUNDAY 19th NOVEMBER '78

- Event 1 — 10 PAIR D/R C'SHIP (Sighter Pair)
- Event 2 — 20 TGT HANDICAP TROPHY (Cummins Shield)
- Event 3 — 10 TGT POINTS 16 m C/D

Secretary: Mr T. Apps,  
9 Curia Street, Mansfield. 3722.

major handicap was fiercely contested and the metre groups were won by Laurie Bernard (11-15m), J. Rist (16-20m), and Kim Bucholtz (21-25m). In the night events Les Brown and Bill Coulson won the Deauville Doubles and Rex Piastrri won the Double Rise Championship.

**EUROA, 24-9-78** — Fine with slight breeze (32). 5pr DR CD: L. Parkes 9-10, G. Willet, D. Hall, A. Petersen, B. Hall divided. 10pr DR Ch: A. Petersen 18-20, A. Sheard 19-24, G. Willet 18-24. 20t Hcp Trophy: D. Hall 39-39, Miss A. Hall 38-39, D. Leonard 28-29. 20t 16m CD: G. Willet, J. King, K. McKendrick divided 20-20.

Good weather was the order of the day for the club's annual Double Rise Championship. Congratulations to Alby Petersen, the outright winner. The Cumming Shield held in conjunction with the Handicap event was won in fine style by the Seymour Team (D. Hall 20, Miss A. Hall 20, D. Leonard 20, G. Willet 19, B. Hall 17) total 96. In the Handicap shoot-off David Hall proved his male superiority by defeating his sister with D. Leonard coming in a worthy third. All in all fine shooting by the Seymour shooters.

**FOSTER, 9-9-78** — Overcast, mild day (17). 10t Pts CD Sweep: 30-30 A. Bremner, 29-30 S. Jennings, 28-30 R. Martin, B. Shellcot, L. Skinner. 25t Mixed Don Osborne Mem Ch 1 2 3 trophies: 23-25 A. Bremner, J. Green, 20-25 R. Martin, D. Missen; shoot-off placings 1st J. Green 39-45, A. Bremner 37-45, R. Martin 36-45; FM S. Jennings. 10t SB 1 2 3 trophies: 10-10 J. Shellcot, B. Stokes, W. R. Jennings, L. Skinner, P. Kuyser, R. Whykes, B. Shellcot; shoot-off placings 1st B. Stokes 31-31, W. R. Jennings 30-31, R. Whykes 26-31. Novelty Event for parcel of fish: B. Stokes, J. Green.

Very pleased to welcome shooters from Morwell, Korumburra and Foster. Congratulations to John Green, winner of the Don Osborne Memorial Day 25t Mixed Tgt Championship. Thankyou to Mr and Mrs Jim Osborne — Don's parents for donating the beautiful trophy and, in attendance, to present the trophy to the winner. Also congratulations to all other winners. Thankyou to all who helped. Thankyou to R. Whykes for donating the beautiful sash and the ladies for once again supplying the delicious afternoon tea; and John Snell for the trap work.

**FRANKSTON-AUSTRALIAN, 6-8-78** — Average (78). 10t Pts CD: 9 divided 30-30. Edithvale DB Ch: 'A' D. Parsell 32-32, F. McCarthy 23-24; 'B' S. Daymond 31-32, L. Cornell 37-38; 'C' M. Rowland 20-21, D. D'Adam 19-21; overall D. Parsell. Edithvale SB Ch: 'A' K. Flentjar 20-20, W. Dalzell 22-23; 'B' J. Jenkins 19-20, D. Estcourt 23-25; 'C' J. Shellcot 24-25, R. Hodge; overall K. Flentjar. 15t Hcp Trophy Event: D. Hall 24-24, A. Perdon 23-24, G. Went 16-17; 19-21 M. DeLorenzo 15-16; 22-25 G. Long 13-15. Edithvale Skeet Ch: open S. Caldwell 38-39, J. Goulden 37-39; restricted W. Meadows 28-29, B. Tressider 23-25. Novice: R. DeVries 7-10, G. McGillivray 7-13.

**FRANKSTON-AUSTRALIAN, 13-8-78** — Overcast (72). 5t Cont Pts CD: 8 divided 5-5. Mordialloc DB Cont Ch: 'A' R. Morrison 26-27, G. Long 25-27; 'B' L. Cornell 17-19, A. Perdon 16-19; 'C' G. Haworth 14-17, R. Hoogenboom 13-17; overall R. Morrison. Mordialloc DB Ch: 'A' N. Salamen 47-47, W. Dalzell 46-47; 'B' D. Edgerton 21-22, P. Clancy 19-20; 'C' B. Harmer 19-20, C. Holt 18-20; overall N. Salamel. Graded Hcp: 11-14m P. Cornelius 15-15, C. White 24-25; 15-18m P. Johanson 22-22, A. Perdon 21-22; 19-21m M. DeLorenzo 15-15, P. Heywood 14-15; 22-25m G. Long 13-15, W. Dalzell 11-15. Mordialloc Skeet Ch: open J. Galluzzo 33-34, R. Merrick 32-34; restricted R. McGillivray 23-25, R. Morrissen 32-36. Novice: G. McGillivray 7-10, S. Rowe 5-10.

**FRANKSTON-AUSTRALIAN, 20-8-78** — Cold and windy (60). 10t Pts CD: equal 1st K. Rose and A. Bremner 30-30, equal 3rd 6 divided 29-30. Bangholme DB Ch: 'A' J. Blackley 36-36, S. Henwood 35-36; 'B' P. Jamieson 33-34, K. Rose 28-29; 'C' C. White 18-19, G. Meuleman 15-16; overall J. Blackley. Bangholme Ladies DB Ch: G. Welch 13-15, L. Meuleman 8-15, J. DeVries 7-15. 20t Hcp Trophy Event: R. Hoogenboom 36-36, N. Salamen 35-36, C. White 27-28; BM R. Morrison 25-26. Bangholme Skeet Ch: open J. Goulden 33-33, S. Caldwell 32-33; restricted R. Morrison 24-25, G. Ash 29-33. Novice: C. Lay 8-11, G. McGillivray 7-11.

**FRANKSTON-AUSTRALIAN, 27-8-78** — Good (77). Carrum DB Pts Ch: 'A' S. Daymond 58-60, M. DeLorenzo 60-63; 'B' L. Heywood 60-60, L. Cornell 56-60; 'C' F. Vella 53-60, R. Hoogenboom 52-60; overall L. Heywood. Carrum DB Ch: 'A' M. DeLorenzo 52-52, R. Allen 51-52; 'B' K. Rose 33-34, P. Jamieson 23-24; 'C' P. DeLorenzo 28-30, J. Schmidt 27-30; overall M. DeLorenzo. 15t Graded Hcp: 11-14m M. Ricci 23-23, R. Shambrook 22-23; 15-18m P. Johanson 18-18, D. Estcourt 17-18; 19-21m M. DeLorenzo 14-15, T. Dawe 13-15; 22-25m I. Buchanan 14-15, G. Long 16-18. Carrum Skeet Ch: open J. Goulden 55-55, M. DeLorenzo 54-55; restricted B. Flint 24-25, G. Clarke 22-25. 25t Skeet Hcp CD: G. Clarke 25-25, equal 2nd J. Waples, B. Tressider, J. Goulden 24-25 divided. Novice: J. DeVries 6-10, I. Faux 6-12.

**FRANKSTON-AUSTRALIAN, 3-9-78** — Fair (85). 5pr DR CD: equal 1st K. Rose and G. Went 9-10 \$38 each, 3rd 5 divided 8-10 \$2 each. Carrum DD Ch: 1st pr A. Bremner and L. Skinner 22-23; 2nd pr T. Proske and A. Zarro 21-23. Carrum DB Ch: 'A' & OA D. Nielson 34-34, I. Buchanan 29-30; 'B' P. Krumins 33-34, J. Goulden 30-31; 'C' A. Tamarro 20-21, R. Gordon 24-26; overall D. Nielson. 15t Graded Hcp: 11-14m R. Gordon 15-15, G. Bennett 14-15; 15-18m J. Kellerman 15-15, P. Johanson 22-23; 19-21m I. Frantantaro 16-17, S. Daymond 17-19; 22+m B. DeVries 15-15, B. Dawe 15-18. Westernport Skeet Ch: open N. Salamen 29-29, B. Dawe 28-29; restricted W. Gibb 24-25, P. Johanson 23-25. Novice: G. McGillivray 8-10, J. DeVries 5-10.

**FRANKSTON-AUSTRALIAN, 10-9-78** — Cold and windy (57). 10t DB Pts CD: L. Skinner, R. Hodgson, B. Dawe 30-30 divided. Lyndhurst DB Ch: 'A' A. Bremner 38-38, W. Dalzell 37-39; 'B' R. Hoogenboom 31-32, D. Edgerton 27-28; 'C' L. Skinner 23-25, F. Vella 22-25; overall A. Bremner. 20t DB Hcp: P. DeLorenzo 24-24, T. Chard 23-24, D. Estcourt 34-35; 19-21m P. Playsted 24-26; 22-25m A. Bremner 17-20. 20t Novelty: L. Skinner 28-28, J. Kellerman 27-28, A. Perdon 25-28. Lyndhurst Skeet Ch: open R. Merrick

35-35, M. DeLorenzo 34-35; restricted R. McGillivray 23-25, D. Parsell 21-25. 25t Skeet Hcp Trophy Event: W. Meadows 47-47, J. Galluzzo 46-47.

**FRANKTON-AUSTRALIAN, 17-9-78** — Wet and cold (90). 10t DB Pts CD: 11 divided 30-30. 20t Winchester DB Teams Ch: 'A' & OA R. Boyce 69-69, B. Webley 68-69; 'B' R. Clarke 34-35, J. Flentjar 32-33; 'C' M. DeMario 33-34, J. Galluzzo 24-25. 20t Hcp: B. Shambrook 22-22, B. Shandley 27-28, B. Ireland 26-28; BM 19-21m M. DeLorenzo 19-20, 22-25m T. Spence 19-20. 5pr DR CD: F. Heinz 10-10, 4 divided 8-10. 25t Mulgrave Skeet Ch: open B. Plower 43-43, G. Long 42-43; restricted F. Heinz 24-25, J. McWilliam 23-26. Novice: S. Mathews 7-10, S. Rowe 6-10.

The Winchester Teams Shoot was conducted over events 2 and 3. The results were: 1st Metro No. 1 187-200, 2nd F.A.G.C. No. 4 183-200, Morwell No. 3 183-200. The winning team of Henry Weitzel, Len Hubbard, Ted Loble, Tom Spence and Bob Dupuy each received a case of shells kindly donated by Winchester and won Metropolitan the right to hold the competition in 1979.

**FRANKTON-AUSTRALIAN, 24-9-78** — Excellent (53). 10t Pts CD: 8 divided 30-30. Club Spring DB Ch: 'A' T. Bradshaw 79-79, R. Evans 78-79; 'B' D. Estcourt 70-71, D. Trembath 32-33; 'C' J. Schmidt 21-22, J. Galluzzo 19-20; overall T. Bradshaw. Club Spring SB Ch: 'A' R. Allen 22-23, T. Rowe 21-23; 'B' P. Heywood 20-20, B. Scotta 21-22; 'C' P. DeLorenzo 19-20, A. Clarkon 18-20; overall P. Heywood. Grouped Hcp: 11-14m C. Scotta 68-69, J. Galluzzo 67-69; 15-18m S. Bickford 27-27, A. Clarkon 33-34; 19-21m M. DeLorenzo 22-22, N. Salameh 24-25; 22+m G. Morgan 17-21, T. Bradshaw 16-21. Club Spring Skeet Ch: open M. Hammond 39-40, M. De Lorenzo 38-40; restricted B. Flint 23-25, M. Rowland 22-25. Novice: S. Morgan 6-10, P. Lay 6-14.

## CLAY TARGET TRAP (SNIPE)

**FOR SALE — \$120.00**

CONVERT. PRESS BUTTON RELEASE  
SPARE PLATE AND PARTS ETC.

Contact Mr Ron Cross

**Pres. Wedderburn Gun Club**

Ridge Street, Wedderburn  
Phone 105

# H.M.A.S.

## CERBERUS

Saturday 4th November

Event 1 Nom \$3.00

10 Targets Points C/D  
Eye Opener

Event 2 Nom \$6.00

20 Targets  
ANNUAL DOUBLE BARREL  
CHAMPIONSHIP GRADED

Sash for each Grade.

Event 3 Nom \$3.00

10 Target Handicap  
Back Markers Trophy.

H.M.A.S. Cerberus Gun Club  
C. Carrol, 5 Catherine Crt.,  
Langwarrin. Vic. 3910.

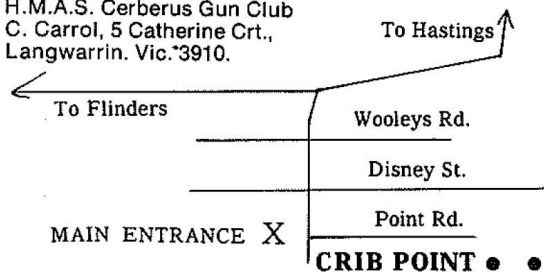

**HAMILTON, 16-9-78** — Fine and windy (30). 10t DB Cont EO: no possibles, 4 shooters 9-10. 20t DB Cont Ch: 'B' & OA A. McIntyre 22-23; 'A' H. Vaughan 21-23; 'C' W. Livingston 21-23. 10t DB Hcp: 8 divided. 15t Sliding Hcp: T. Nash and G. Schmidt 14-15, T. Gould and R. Hammet 13-15.

The windy conditions made the targets most difficult. No handicaps were altered.

**HEATHCOTE, 16-9-78** — Calm, cloudy, patches of sun (32). 5t EO off Hcp PD: J. Cumming, J. Maxwell, R. Fraser, J. Farley, B. Warren, K. Warren, W. Elsbury, R. Daley, T. Marchment. 15t DB Hcp: R. Edmonds (Kyneton) 29-29, G. Moore (Kyneton) 28-29, B. Warren (Heathcote) 26-27; FM shared by D. Clouston and C. Blair 14-15; John Maxwell won BM with 19-20 but gave his trophy to the FM. 5pr DR off 16m: K. Warren 10-10 \$16, G. Moore 9-10 \$11. Jackpot: Roy Tattersall missed out. Off The Fence: G. Mannix.

Great shoot-off between 12 and 22 marker, the young one up front eventually coming out on top. Congratulations to both. Our trap boy David Clouston shot well for the FM.

**HORSHAM, 9-9-78** — Cool (85). 20t NW Zone DB Graded Ch: 'B' & OA J. Colwill 75-75, D. Dunn 74-75; 'A' B. England 36-37, N. Hinneberg 24-25; 'C' W. Merrett 33-34, K. Heard 21-22. 50t President's DB Graded Ch: 'A' & OA B. Wagg 55-55, D. Flavel 54-55; 'B' J. Colwill 49-50, N. Block 52-54; 'C' R. Papst 53-56, R. Hounsell 52-56.

Congratulations to John Colwill for winning the double in 'B' grade; and to Basil Wagg for his win in the President's Championship. R. Papst received a one metre penalty. Bert Robinson was awarded life membership of the club for his untiring services; congratulations Bert!

**JEPARIT, 17-9-78** — Showers (89). Club DB Ch: 'B' & OA R. Scott (Horsham) 109-109, R. Porter (Horsham) 54-55; 'A' D. Bull (Horsham) 109-108, D. Flavel (Jeparit) 91-92; 'C' D. Witney (Jeparit) 43-44, M. Jarvis (Maryborough) 29-30. Ladies: Helen Flavel (Jeparit) 27-30; Juniors: M. Leech (Maryborough) 30-31. 30t Cash Hcp: \$30 each group 11-14m S. Hounsell, L. Izard, P. Shilling; 15-17m H. Flavel, R. Hounsell, R. Scott; 18-21m R. Bull, D. Flavel, 90% T. Pitt, B. Duthie 10%.

A one metre penalty to D. Witney 008332 and R. Scott 010043. R. Scott and D. Bull also to be congratulated on their shooting to each gain a 100-break badge. Thanks also to our State President Mr Bob Buchan for his participation in the referee's forum held before the shoot.

**KANIVA, 24-9-78** — Fine and warm. West Wimmera Cont Ch: 'A' & OA J. Wagg 23-23, E. Hall; 'B' F. Pitt, J. Hinge; 'C' C. Williams, J. Manz. Trophy Hcp Metre Groups: 11-15m P. Merret (Kaniva), S. Hinge (Bordertown); 16-19m N. Block (Goroke), I. Bell (Bordertown); 20-25m J. Colwill (Kaniva), S. Bethune (Goroke). 5pr DR 10t Pts: R. Andrews, 2nd shared by D. Hicks, Eric Hall and N. McDonald.

**KERANG, 1-9-78** — Fine (44). 10t SS 16m: possibles by L. Bernard, A. Turner, K. Burton, P. Parsons, R. Wilkinson, F. James, G. Wilkinson, C. Penno. 20t Loddon Valley DB Ch: S. Kerr 27-27, K. Boston 26-27, L. Saunders

# WERRIBEE GUN CLUB

VIC

**SUNDAY 12th NOVEMBER**

Event 1

20 TGT DB HANDICAP

Trophy for OA winner & best each group 11-16, 17-21, 22-25m.

Event 2

20 TGT TARNEIT DB  
GRADED C'SHIP

**SUNDAY 26th NOVEMBER**

Event 1

WERRIBEE CHAMPION  
OF CHAMPIONS  
25 tgts from 20 m

Event 2

20 TGT CLUB  
POINTS GRADED C'SHIP

President:  
W. Abbott.

Secretary:  
T. Foley,  
10 Bernhardt Ave.,  
Werribee 3030.  
Phone (bus) 398 1511.

# HAMILTON GUN CLUB

**SATURDAY NOVEMBER 18th**

12.30 p.m. start

Event 1

10 TGT DB CONT E/O

Nom \$2.00

Event 2

Nom \$9.00

**COMMONWEALTH  
DB CONT.**

**CHAMPIONSHIP**

50 cents Opt Sweeps each 10 tgts \$2.00

Sash & Trophy first each Grade

Trophy second each Grade.

Event 3

15 TGT TROPHY HCP

Nom \$5.00

Trophies 1st 2nd 3rd FM & BM 20 & over  
50 cents Opt Sweep each 7 & 8 targets \$1.00.

TOTAL NOMS  
& SWEEPS \$19.00

**SATURDAY DECEMBER 16th**

1.00 p.m. start

Event 1

XMAS DB C'SHIP

Sash for Outright winner plus trophy.  
Ribbon plus trophy for Grade winners.

Event 2

XMAS HANDICAP

Free Barbecue & Refreshments  
After Shoot

**GROUND LOCATION:**  
3.5 km south on Pt Fairy Road.

President:  
H. Vaughan.  
055 723354.

Secretary:  
L. Howlett.  
055 723145 B.H.

# MELBOURNE GUN CLUB NOVEMBER 1978 PROGRAM

Grounds: Victoria Road, Lilydale —

P.O. Box 74 Lilydale — Phone: 739 1771

## SATURDAY NOVEMBER 4th commencing 10.30 a.m.

Event 1 Nom \$20.00

### 100T STATE TRENCH GRADED CH.

Trophies OA & 1st & 2nd each grade.

Event 2 Nom \$17.00

also commencing 10.30 a.m.

### 100T STATE I.S.U. SKEET CH.

A & B Grades. Trophies OA, 1st & 2nd each grade.

IN CONJUNCTION WITH EVENT 2

LAST 50 TARGETS WILL COUNT AS EVENT 3

Event 3 Nom \$8.00

### CLUB ISU SKEET CHAMPIONSHIP

A & B Grades. Gold badge to top scoring Club Member - Sash & Trophies to OA & 1st & 2nd in each grade.

**NOTE:** Shooters competing in events 2 & 3 which will be shot in conjunction will pay a nomination fee of \$22.00.

## CUP DAY — NOVEMBER 7th NO SHOOT

Metro Grand Prix & Team Shoot  
MGC teams to attend, contact teams captain.

## SATURDAY NOVEMBER 11th commencing 1 p.m.

Event 1 Nom \$8.00

### 50T ALFRED DUNHILL DB GRADED CHAMPIONSHIP

Perpetual Trophy to be held for 12 months by OA winner. Sash and Trophy 1st, Trophy 2nd each grade & 11-13m.

Event 2 Nom \$5.00

### 20T CLUB WALK-UP CH.

Aggregate Event.

Gold badge for top club scorer - Gold sash non-member.  
Ribbon & Trophy 1st each grade, Trophy 2nd.

**NOTE:—**

## FRIDAY 10th, SATURDAY 11th & SUNDAY 12th NOVEMBER STATE SKEET CARNIVAL

See full advertisement elsewhere for details.

## SATURDAY NOVEMBER 18th commencing 12 noon

Event 1 Nom \$10.00

### 50T CITY OF MELB TRENCH CH ABC

Event 2 Nom \$5.00

### 20T CITY OF MELB DB PTS GRADED CH.

Event 3 Nom \$5.00

### 20T CITY OF MELB DB GRADED CH

Event 4 Nom \$5.00

### 20T CITY OF MELB MEDLEY CH.

10t SB, 10t DB

Event 5 Nom \$8.00

### 50T CITY OF MELB GRADED

SKEET CH.

AB & C

## SATURDAY NOVEMBER 25th commencing 12 noon

Event 1 Nom \$6.00

### 25T DON McCRAITH TRENCH CH.

GRADED A B C

Event 2 Nom \$9.00

commencing 1.15 p.m.

### 50T DON McCRAITH DB GRADED CH.

OA winner - Seiko digital watch - Value \$150

Event 3 Nom \$10.00

### 20T DON McCRAITH HANDICAP

1st Sony Stereo 3-in-1 - Value \$300.

2nd Seiko watch, 3rd Seiko watch;

22-25 metres Seiko watch.

Event 4 Nom \$9.00

### 50T DON McCRAITH GRADED

SKEET CHAMP.

OA winner - Sony stereo 3-in-1 - Value \$300.

**NOTE** 1/2 Cost this trophy kindly donated.

Ribbon & Trophy grade winners - Value \$50,

2nd each grade.

**HIGH GUN** over events 2 3 & 4

Winner will receive Sash & Trophy

& hold Gold Cup for 12 months.

**VENETO CLUB will hold usual SUNDAY SHOOT on  
NOVEMBER 19th. commencing 12 noon.**

Ladies Event each day  
if sufficient entries.

## DATES TO REMEMBER:

DECEMBER 9th — AGGREGATE EVENTS DB & MIXED TARGETS.  
ALSO ROYAL DOULTON SKEET EVENT — DECEMBER 16 — CHRISTMAS SHOOT.

All usual amenities available on ground.

**PRACTICE:** Wednesdays commencing 1 pm  
and Saturdays commencing 10.30 a.m.

President: R. Buchan.  
Phone 870 5459.

Secretary: Mrs Jan Brunt,  
23 Coven Avenue, North Bayswater.  
Phone: 729 5328.



23-24; FM D. Douglas 16-20. 15t Hcp Trophy: 10 possibles K. Boston 46-46, C. Penno 45-46, L. Saunders 29-30.

**KORUMBURRA, 23-9-78** — Cold, SE breeze (20). 10t Pts Hcp: N. Court 19, P. Green 17 30-30, N. Adams 12, L. Bradley 17, J. Farmer 14, C. Wilkinson 18 29-30. 15t DB Hcp: G. Bennett 14, L. Bradley 17, J. Chapple 20, N. Court 19, T. Gannon 15, S. Jennings 11 15-15. 15t SB Hcp: L. Bradley 17 15-15, N. Adams 12, J. Chapple 20, P. Green 17 14-15. 10t Cont off 16m: A. Bird, S. Jennings, P. Kuyer, W. Pryde, J. Shellcot 10-10. 10t Tower DB: L. Bradley, M. Edgar, K. Gannon, S. Jennings, W. Pryde, C. Wilkinson. Cake: P. Green.

An all Compulsory Cash Division day.  
**KYNETON, 10-9-78** — Fine and windy (40). 10t Pts: 11-16m J. McCarthy 30-30, B. Craggill, H. Golding, B. Fleming 28-30; 17-25m N. Paterson 30-30, J. Hill, A. Beaton, D. Hill 28-30. 20t SR Ch: 'A' & OA N. Paterson, A. James; 'B' J. Maxwell, D. Hill; 'C' B. Fleming, S. Hubezak. 15t Hcp: J. O'Meara, A. Holland, R. Fraser; Novice K. Skinner; BM D. Hill. Jackpot: B. Craggill "not won".

Norm Paterson shot well to win the Silent Rise Championship. John O'Meara scored a good win in Hcp event from Alan Holland.

**MANSFIELD, 17-9-78** — Overcast and windy. 10t EO CD SB: G. Willetts and K. McKendrick shot the possible. Mansfield G.C. SB Ch: G. Willetts 18-20, N. Phipps 18-21, A. Petersen 17-21. 20t Hcp Trophy: J. King 35-35, A. Sheard 34-35, P. Brock 24-25. 10pr DR CD: G. Willetts 20-20, T. Newman and T. Apps 18-20 shared.

**MELBOURNE, 2-9-78** — Fine and mild (115). 25t Trench Hcp: R. Devries 47-51, J. Napoli 45-51, R. A. Clarke 35-45. 20t Wattle DB Pts Graded Ch: 'A' & OA W. Abbott 63-63, B. Shandley 71-72; 'B' M. Vipond 60-63, N. Sepe 77-78; 'C' D. MacDonald 56-60, V. Navantri 55-60; 11-13m P. Menara 54-60. 20t Hcp: L. Danese 53-53 2 metre, J. Kellerman 52-53 1 metre, L. C. Smith 39-40 1 metre; 20-22m K. Calder, 23-25m L. Nuzzolese. 20t Wattle WB Graded Ch: 'A' & OA W. Iles 54-54, L. Spinosa 42-43; 'B' B. Scotta 53-54, J. Collins 44-45; 'C' T. Vincent 26-27, N. Dizane 20-21; 11-13m J. Jennings 19-20. 10pr Wattle DR Graded Ch: 'A' L. Nuzzolese 18-20, 'B' P. Krumins 17-20, 'C' N. Bailey 14-20. 50t Wattle Skeet Graded Ch: 'A' R. Buchan 57-58, J. Taibly 53-54; 'B' P. Krumins 48-50, A. R. Tongs 49-50; 'C' L. Danese 46-50, B. Scotta 48-55.

**MELBOURNE, 9-9-78** — Overcast and mild (110). 50t Yarra Glen Trench Graded Ch: 'A' & OA J. Henwood 47-50, 'B' J. Whittakers 46-51, 'C' S. Daymond 44-50. 20t Yarra Glen DB Pts Graded Ch: 'A' S. Henwood 57-60, B. Filippelli 56-60; 'B' & OA D. Martyn 59-60, R. Hansen 57-60; 'C' V. Navantri 56-60, L. Danese 66-75; 11-13m T. Peters 64-75. 20t Hcp: P. Arnold 68-68, N. Sepe 67-68, D. Menara 60-61; 22-25m F. Reade 18-20. 20t Yarra Glen DB Graded Ch: 'A' & OA J. Henwood 47-47, I. Buchanan 40-41; 'B' G. Bennett 46-47, S. Stammel 42-43; 'C' R. Gordon 20-21, G. Austin 19-21; 11-13m P. Menara 23-25. 50t Yarra Glen Skeet Graded Ch: 'A' J. Summers 49-50, N. Moore 60-62; 'B' & OA P. Krumins 49-50, J. R. Galluzzo 47-50; 'C' A. Blackmore 55-58, P. Blackmore 55-56.

**MELBOURNE, 16-9-78** — Overcast and light breeze (150). 25t Yarra Valley Trench Graded Ch: 'A' G. Long 29-30, 'B' M. Whitelaw 30-31, 'C' & OA L. Bradley 31-31. 20t Yarra Valley DB Pts Graded Ch: 'A' W. Abbott 98-99, L. Smith 86-87; 'B' R. Clarke 105-105, P. Thompson 71-72; 'C' & OA G. Haworth 108-108, D. Whittle 57-60; 11-13m L. Danese 55-60. 20t Hcp: C. LeBlanc 59-59, S. Draper 58-59, W. Petersen 49-50; 22-25m I. Buchanan 20-21. 20t Yarra Valley DB Graded Ch: 'A' & OA K. Lowry 85-85, J. Henwood 84-85; 'B' D. Luelf 70-71, M. Piccolo 64-65; 'C' G. Haworth 35-36, J. Aukema 21-22; 11-13m J. Catelli 19-20. 20t Yarra Valley Skeet Graded Ch: 'A' & OA L. Bradley 50-50, K. Lowry 71-72; 'B' R. DeVries 48-50, J. R. Galluzzo 47-50; 'C' L. Brooks 45-50, J. Jenkins 48-54. 5th Eastern Zone Skeet Teams Premiership round I: Melb. No. 1 235-250, Melb. No. 2 231-250, Korrumburra No. 1 229-250, Frankston/Aust. No. 2 229-250. 20t Ladies Hcp: Mrs H. Strautins 20-20.

**MELBOURNE, 23-9-78** — Strong breeze, overcast and light showers (130). 50t Trench Trophy Event: A. Rowe 50-50, K. Lowry 71-75, J. Henwood 70-75; 3-10 hcp B. Stokes 43-50. 50t Warrandyte Trench Graded Ch: 'A' & OA K. Lowry 62-65, G. Long 61-65; 'B' R. Schwarz 47-52, R. Polese 46-50; 'C' A. Hine 45-50, P. Playsted 44-50. 20t DB Graded CD: 'A' divided G. Willett and J. Walls, R. McGillivray; 'B' M. Rowland, B. Harmer, 3rd D. Martyn; 'C' B. Stokis, 2nd & 3rd divided L. Fitzpatrickk, V. Navantri and J. Maloni. 20t Hcp: G. Harrap 21-21, G. Guy 20-21, A. Lavis 41-42; 22-25m A. Spence 18-20. 20t Warrandyte DB Graded Ch: 'A' & OA V. Mollica 43-43, N. Salamen 24-25; 'B' J. Jenkins 25-26, D. Martyn 28-29; 'C' L. Hine 42-43, L. Danese; 11-13m J. Catelli 19-20. 50t Warrandyte Skeet Graded Ch: 'A' & OA M. T. Hastie 67-68, N. Salamen 48-50; 'B' W. Meadows 66-68, L. Danese 58-64; 'C' P. Blackmore 50-52, B. Harmer 48-51.

Trench Overall High Gun: 1st to be shot off. Teams Match: 1st Melbourne No. 1 540-600; Frankston/Australian vs. Melbourne - K. Lowry, R. Boyce, J. Henwood, P. Morton, L. Nuzzolese, M. Whitelaw.

**MELBOURNE, 24-9-78** — Fine and mild (120). 50t Melb.-Wang. Trench Graded Ch: open 'A' & OA K. Lowry 50-50, J. Henwood 49-50, G. Long 53-56; 'B' B. Ireland 46-50, J. Napoli 45-50, S. Daymond 41-50; 'C' N. Quick 45-50, N. Daymond 44-50, M. Baker 43-50; restricted 'A' A. Penney 45-50; 'B' G. Boyd 48-50, D. Jackel 47-50, C. Kneebone 45-50; 'C' K. Robinson 46-53, L. Brown 45-53, S. Crisci 43-51. 30t Melb.-Wang. DB Graded Ch: 'A' W. Attwood 45-46, L. C. Smith 76-77, N. Bienvenu 75-77; 'B' & OA N. Hendy 50-50, J. Napoli 33-34, J. Jenkins 67-68; 'C' M. Sepe 30-31, N. Quick 51-52, B. Pigram 50-52; Ladies: Mrs S. Lowry 27-30.

50t Melb.-Wang. Skeet Graded Ch: 'A' & OA R. Buchan 84-85, K. Lowry 83-85, M. T. Hastie 78-80; 'B' J. McGregor 49-50, N. Simmons 48-50, Miss K. Williams 52-56; 'C' M. T. Crockett 46-50, G. Stanek 52-58, N. Guida 51-58; Ladies: Mrs B. Hendy 42-50. Melb.-Wang DTL team - 1st Melb. II 147-150, R. Hansen, L. Smith, V. Bidstrup, N. Bienvenue, B. Ireland; Melb.-Wang. Skeet Team - 1st Melb. No. 1 R. Buchan 49, M. Hastie 49, N. Moore 46, K. Lowry 49, S. Daymond 49 = 242-250.

**MORNINGTON, 26-8-78** — Fine and mild (27). 10t Pts EO: Keith Fientjar 26-30, Len Heywood 25-26, Jack Frost 23-30. 20t Pts Ch Graded: 'C' & OA Guy Howarth 51-60, 'A' Keith Fientjar 50-60, 'B' Len Heywood 48-60. 20t Hcp: Chris Carrol 19-20, Guy Howarth 18-20, Colin Quick 29-32.

**MORNINGTON, 9-9-78** — Fine and mild (30). 10t Pts: Mick Charlesworth 30-30, Arthur Bird 35-36, Chris Carrol 32-36. 20t DB Graded Ch: 'A' & OA John Blackley 33-34, 'B' Len Heywood 20-21, 'C' Arthur Bird 21-22; FM Phillip Arnold 19-23. 20t Hcp: Bill Woodward 20-20, Mick Charlesworth 21-22, Len Heywood 20-22.

**MORNINGTON, 23-9-78** — Fine and cool (31). 10t Pts CD: P. Heywood 30-30, D. Walker, C. Carrol, G. Howarth 29-30. 30t DT: G. Scalise and G. Iuliano 8-12, C. Carrol and P. Heywood 7-12. 10t Hcp: J. Noy 20-20, G. Scalise 19-20, T. Ferlazzo 13-14. 10pr Mini DD: W. Pilkington and M. Mollica 16-17, K. Flentjar and J. Fientjar 15-17.

**MORWELL, 16-9-78** — Fine and sunny (35). 10t Pts EO Hcp: Mrs L. Marriott 30-30, P. Fitzmaurice 29-30, 3rd N. Lapham and N. Rouse 28-30. 20t SB Hcp: P. Marriott 20-20, B. Hay 22-24, J. Hollonds 21-24; FM N. Lapham 17-20. 20t Club Cont Ch: B. Stokes 21-22, L. Hines 20-22, R. Jennings 26-28; FM J. Farmer 18-20. Cake Shoot: R. Whykes.

Congratulations to Lois Marriott and son,, Peter, on their respective wins; also Bernie Stokes in Continental. Good shooting by new shooter Bruce Hay to come in the Single Barrel.

**MT BOGONG, 3-9-78** — Wet and cloudy (34). 15t Hcp: I. McGeogh 52-52, S. Crisci 52-53, J. Rigoni 51-53; FM S. Cobbe. Keiwa Valley SB Ch: 'A' D. Conners 29-30, 'B' & OA A. Collins 15-15, 'C' E. Tomajoni 15-17. 5pr DR: 'A' T. Whitehead 14-16, 'B' J. Rigoni 15-16, 'C' S. Crisci 14-16.

## NOORAT GUN CLUB

SATURDAY 25th NOVEMBER '78  
Club Deauville Doubles C'ship

- Event 1 — EYE OPENER 6 PAIRS  
Event 2 — CHAMPIONSHIP 20 PAIRS  
Event 3 — HANDICAP 11-15m 16 & over

Secretary: P.O. Box 42,  
Terang 3264.

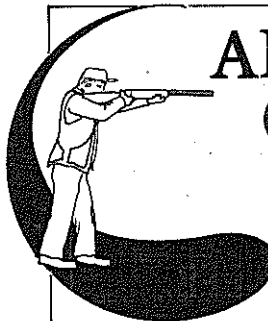

## ALEXANDRA GUN CLUB

VICTORIA

(AFFILIATED WITH A.C.T.A.)

Unfortunately our club grounds have been sold, and so we are forced to cease shooting for some months. We apologise for any inconvenience caused by our cancellation of our advertised program. We will still be holding our Annual Field Shoot in January (watch for advert).

Watch C.T.S.N. for news of our opening at our new location.

PRESIDENT

Barry Pyke

"Cloverley"

Crystal Creek, Alexandra

(057) 72 1189

SECRETARY

Mrs. Sue McNair

13 The Boulevard

Eildon

(057) 74 2118



# GEEELONG GUN CLUB

## NOVEMBER PROGRAM

( Affiliated A.C.T.A. )

### GEEELONG SPRING "DING" FESTIVAL

**SATURDAY 4th**  
10.30 a.m. start

- Event 1 15 TGT HANDICAP E.O. Nom \$3.00
- Event 2 30 TGT SPRING "DING" HANDICAP Nom \$15.00  
1st Winchester Model 96 Xpert U.O Shotgun and Sash Value \$510;  
1st 2nd & 3rd in 4 metre groups (11-13) (14-16) (17-20) (21-25)  
1st each Group Pair Binoculars Value \$50  
2nd each Group Winchester Shot Value \$30  
3rd each Group 1000 Primers Value \$15  
Junior & Ladies Trophy Nom \$3.00
- Event 3 SPRING "DING" DB C'SHIP Graded A B C Nom \$6.00  
1st each Grade Sash & Trophy, Trophy 2nd each Grade.
- Event 4 CITY OF GEEELONG DB CH. Graded A B C Nom \$6.00  
1st each Grade Badge & Trophy, Trophy 2nd each Grade.

#### BBQ FACILITIES AVAILABLE

**SUNDAY 5th**  
12.00 start

- Event 5 50 TGT SPRING "DING" SKEET CHAMPIONSHIP Nom \$8.00  
OA winner Sash & Trophy, Badge and Trophy in each Grade 0-1, 2-4, 5-10.  
SKEET SS TIME PERMITTING

**SATURDAY 11th**  
1.00 start

- Event 1 10 TGT PTS E.O. 16 m Nom \$2.50
- Event 2 STH BARWON DIST DB CH. Nom \$5.00  
1st Badge & Trophy, Trophy 2nd 3rd & FM
- Event 3 STH BARWON DIST SB CH. Graded A B C Nom \$5.00  
OA Badge, Trophy each Grade.
- Event 4 CITY OF GEEELONG SB TOWER CH. Nom \$5.00  
Badge & Trophy 1st, Trophy 2nd & 3rd.

**SATURDAY 18th**  
1.00 start

- Event 1 10 TGT HANDICAP E.O. Nom \$2.50
- Event 2 20 TGT \$3000 TROPHY HCP Nom \$7.00  
1st 2nd 3rd; BM Trophy.
- Event 3 20 TGT DB C'SHIP Nom \$5.00  
Badge & Trophy 1st, Trophy 2nd 3rd & F.M.

**SATURDAY 25th**  
1.00 start

- Event 1 10 TGT PTS E.O. 16 m Nom \$2.50
- Event 2 EASTERN GARDENS DB CH. Nom \$5.00  
Sash & Trophy 1st, Trophy 2nd 3rd & FM
- Event 3 20 TGT HANDICAP Nom \$6.00  
Three Equal Trophy.  
Nominations New Year's Day Grand Prix
- Event 4 EASTERN GARDENS SKEET CH. Nom \$5.00  
Badge & Trophy each Grade, 0-1, 2-4, 5-10.

President:  
R. Green  
126 Ryrie Street,  
Geelong 3220.  
Phone 052-98514.

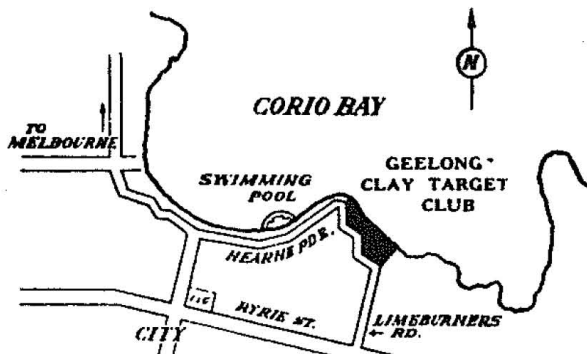

Honorary Secretary:  
A. Storrar,  
43 Hibiscus Crescent,  
Newcombe 3219.

**NOORAT, 23-9-78** — Fine, cool, slight breeze (16). 5t EO Pts: S. Nelson (Cobden) 14-15, P. Stinchcombe (Colac) 11-15, J. Ballagh (Colac) 9-15. Zone Ch WU 20t: John Chisholm 14-20, Brett McNamara 13-20, H. Squires 13-20; FM D. Higgins 10-20. 15t Hcp: L. McDonald (W'bool) 15-15, D. Higgins (W'bool) 14-15, B. McNamara 14-15; FM L. Dwyer 13-15.

The Walk-Up event though not popular with the majority of shooters, seemed to test those that did compete as indicated by the scores. As you will observe the placegetters are all very experienced shooters. Congratulations to them. As mentioned prior D. Higgins is definitely a shooter to watch, having performed well at Shepparton and W'bool recently and among the placegetters at Noorat again. Brett McNamara a new registered shooter of 13 years, is also a shooter to watch, and will not be on 11 metres very long.

**PUCKAPUNYAL, 27-8-78** — Windy and overcast and cold (30). 10t EO 16m Pts: A. Spence 29-30, W. Mathieson 27-30, G. Griener 27-30. 20t SB Graded Ch: 'A' & OA R. Lambden 20-20, A. Spence 13-20; 'B' J. Maxwell 17-20, K. Mulvaney 19-23; 'C' M. Heritage 18-20, J. Rist 17-20; best Lady shooter S. Pathe 10-20. 15t Hcp: G. Greiner 19-19, R. Lambden 18-19, B. Felstead 17-18; BM A. Spence. 20t DB 16m CD: G. Brown, A. Spence, K. Mulvaney 20-20.

**SEBASTOPOL, 17-9-78** — Damp (55). Hcp: T. Nash 29-30, M. Kingwill 26-28, M. Thomas 24-26; 19-25m R. Cartledge 27-30. DB Ch: 'A' R. Cartledge 39-39, G. Moore 38-39, B. Mark 23-25; 'B' P. Edmondson 21-22, P. Verlander 20-22, T. Light 21-23; 'C' R. Tremul 19-20, R. Jabarin 28-30, J. Cauci 28-31; OA R. Cartledge 39-39. 15t Pts: N. Paterson, R. Mark, R. Cartledge divided 44-45; 11-15m C. Bumpstead.

Congratulations to Trevor Nash on winning the Handicap from 21 metres. **SEYMOUR, 10-9-78** — Fine and mild (27). 10t DB 16m CD EO: 6 possibles M. Stritthof, B. Hall, K. Mulvaney, J. King, B. Pyke, G. Willett. 15t DB Club DB Pts Ch: A. Petersen 53-54 pts, G. Willett 52-54 pts, R. Lambden 50-54 pts; FM M. Smits 36-45 pts. 10t DB Hcp CD: 5 possibles K. Mulvaney, W. Borden, D. Leonard, B. Pyke, G. Willett. 10t DB Cont 16m: 2 possibles W. Borden, G. Willett. 10t DB Cont 18m: 2 possibles R. Lambden, G. Willett.

The Club would like to congratulate Miss Allison Hall on winning the Victorian State Ladies Single Barrel Championship and Mr Graeme Willett on winning the Commonwealth Single Barrel Championship.

**STAWELL, — Rain (39).** EO divided W. Atwood, P. Scott, B. Jenkins, L. Johnston, R. Pickford, G. Pitcher, G. McClure, D. Moy. NW Zone PD 5 trap Ch: B. Rafferty 42-45 (Maryborough), P. Scott 41-45 (Stawell), R. Bell 27-30 (Stawell). Grampion SB 5 trap Ch: P. Scott 10-10 (Stawell), L. Dowsett 9-10 (Stawell), N. Paterson 18-20 (Ballarat).

Congratulations to P. Scott for shooting possibles in both events, winning one and 2nd in the other.

**TATURA, 17-9-78** — Fine (37). 10t EO: divided 12 shooters. Nthrn Zone Mxd Tgt Ch: Neil McPherson 31-35, V. Ryan 30-35, R. Piastrri 29-35; FM P. Gunnell 28-35. 15t Trophy Hcp: S. Atkins 26-26, G. Corry 25-26, D. Souter 24-28.

# WANGARATTA GUN CLUB

(Affiliated A.C.T.A.)

## FRIDAY 17th NOVEMBER

start 7 p.m. — D.T.L.

- |         |  |            |
|---------|--|------------|
| Event 1 | 15 TGT TROPHY HANDICAP<br>Optional Sweep \$1.00.   | Nom \$4.00 |
| Event 2 | NORTH EAST ZONE<br>D.B. CHAMPIONSHIP<br>Optional Sweep \$1.00.                                     | Nom \$6.00 |
| Event 3 | WANGARATTA H.G. C'SHIP<br>Open to shooters that have won a High Gun award at Wangaratta this year. |            |

## SATURDAY 18th NOVEMBER

start 1 p.m. — SKEET

- |         |                             |             |
|---------|-----------------------------|-------------|
| Event 1 | 25 TGT KING VALLEY DIST CH. | Noms \$5.00 |
| Event 2 | 25 TGT TROPHY HANDICAP      | plus O/S    |
| Event 3 | 25 TGT C.D. HANDICAP        | \$1.00 each |

Shooting Grounds: Rear Vine Hotel, North Wangaratta.

Pres: J. Cooper, 17 Cavanagh St., Wangaratta; Sec.: S. Stafford, P.O. Box 334, Wangaratta. Phone: 21 5275. PLEASE NOTE: in the advt. that the Wangaratta Gun Club will hold its Annual Meeting at the Wangaratta Club, Victory Parade, Wangaratta, on Friday 24th November, at 8 p.m.

# KERANG CLAY TARGET CLUB

## Winchester Tournament Program

10th and 11th November 1978

Friday 10th commencing 8 p.m.

- |         |  |             |
|---------|--|-------------|
| Event 1 | 15 T Eye Opener off 16 m   | Nom \$3.50  |
| Event 2 | 20 T Kerang Lakes DB<br>CHAMPIONSHIP<br>Opt Sweeps \$1.00.                   | Nom \$5.50  |
| Event 3 | 15 T Handicap Trophy<br>Opt Sweep 50 cents.                                  | Nom \$3.50  |
| Event 4 | 20 T Northern District PS<br>CHAMPIONSHIP Graded A B C<br>Opt Sweeps \$1.00. | Nom \$5.00  |
| Event 5 | 30 Target<br>WINCHESTER TOURNAMENT<br>off 16 metres                          | Nom \$20.00 |

See pages 25 & 27 of May Shooters News for details of trophies and conditions.

- |         |   |            |
|---------|---|------------|
| Event 6 | 15 T Handicap Trophy<br>Opt Sweep 50 cents.<br>BARBECUE TEA<br>NIGHT commencing 8 pm NIGHT  | Nom \$3.50 |
| Event 7 | 20 T Northern District SB<br>CHAMPIONSHIP Graded A B C<br>Opt Sweeps \$1.00                 | Nom \$5.00 |
| Event 8 | 20 T Northern District DB<br>CHAMPIONSHIP Graded A B C<br>HIGH GUN SASH ON EVENTS 4 5 6 7 8 | Nom \$5.00 |

Club reserves right to alter the program if necessary.

Refreshments & Cartridges Available at Grounds.

FOR ACCOMMODATION:

Kerang Caravan Park (some on site vans) ..... Phone 521161  
Ibis Caravan Park (some on site vans) ..... Phone 522232  
Kerang Motel ..... Phone 521311  
Cascade Motel ..... Phone 522104  
Commercial Hotel ..... Phone 521031

### BOORT CLAY TARGET CLUB SHOOT

Sunday 12th November 1978

Double Rise Championship and other events.

Pres.: Frank JAMES,  
30 Nolan Street, Kerang.  
Phone 521107.

Sec.: Chris PENNO,  
Police Station,  
Kerang.

**Saturday November 25th, 6 pm start**

# Warracknabeal Gun Club

(Vic.)

Affiliated A.C.T.A. & V.C.T.A.

1. Club Twilight Single Barrel C'ship.
2. \$50 Cash Handicap.
3. District Night Double Barrel C'ship.

TEA AVAILABLE ON GROUNDS,  
supper, refreshments & cartridges available.

G. F. Pike, Pres.

J. T. Clark, Sec.

**TOOLONDO, 3-9-78** — Overcast and raining (49). 4pr DD EO 18m: shared by the 12 possibles 4-4. 20pr Club DD Ch 18m: H. Vaughan and L. Howlett (Hamilton) 36-36, G. Steele and T. Niven (Mt Gambier) 35-36, J. Witney and R. Newell (Warracknabeal) 32-33. 15t Hcp SS: C. Budde, H. Vaughan, R. Scott, R. Kilpatrick, A. Cameron Jnr, N. Block 15-15.

Thanks to all the shooters who travelled long distances on such a shocking day to make the shoot a success.

**VENETO, 17-9-78** — Overcast and light breeze (80). 10t EO Hcp CD: 23 shooters divided the cash. 20t DB Hcp: S. Arcaini 27-27, P. Arnold 26-27, D. Perna 24-25; "Novice Junior" 1st C. Scotta 19-20, 2nd D. J. Maloni 18-20. 10pr DR Graded Ch: 'A' M. Italia 21-24, W. Henwood 20-24; 'B' A. Stellato 17-20, G. Went 16-20; 'C' E. Bertollo 17-20, P. Zorzi 16-22.

**VICTORIAN, 23-9-78** — Cold, fine (87). DB CD 16m: 20 possibles. 15t Hcp: S. Smith 68-68, B. Edwards 67-68, J. Fortunato 36-37.

**VICTORIAN, 30-9-78** — Fine cold (101). 15t DB Pts Ch: S. Teboneras 45-45, K. Calder 53-54, M. Italia 52-54; FM W. Mathieson 47-51. 15t DB Hcp: 1st D. Snell and C. Oteri shared 42-42, 3rd D. Peterson 41-42.

**VICTORIAN, 2-9-78** — Warm, mild (68). 20t DB Ch: D. Hill 25-25, M. Paterson 24-25, V. Mollica 22-23; FM G. Davis 22-24. 20t DB Hcp: S. Harding 36-36, N. Guida 37-39, G. Couper 35-36. 10t DB Pts shoot-off: G. Went 23-23, J. Hill 22-23, D. Perna 18-19.

**VICTORIAN, 6-9-78** — Cold fine (98). 8pr DR Ch: W. Iles 16-16, R. Morrison 21-23, R. Howden 20-23; FM G. Freeman 14-16. 16pr DD Ch: A. Bradshaw and M. Little 46-46, R. Morrison and R. Evans 45-46.

## MILDURA CLAY TARGET GUN CLUB

**SATURDAY 4th NOVEMBER '78**

commencing at 1.30 p.m.

- |         |                              |            |
|---------|------------------------------|------------|
| Event 1 | 10 TGT S.S. OFF HCP          | Nom \$4.00 |
| Event 2 | TROPHY SHOOT 20 TGTS OFF HCP | Nom \$6.00 |
| Event 3 | SKREET SS div 0-1, 2-10      | Nom \$5.00 |

Hon. Sec.: Laurie Connors,  
P.O. Box 19, Mildura 3500.  
Phone 23 2567.

## EUROA GUN CLUB

**SUNDAY 26th NOVEMBER**  
1 p.m.

- |         |   |            |
|---------|---|------------|
| Event 1 | 10 tgt 16 m C.D.                            | Nom \$2.50 |
| Event 2 | 20 tgt EUROA GUN CLUB<br>CHAMPIONSHIP       | Nom \$6.00 |
| Event 3 | 15 tgt Handicap C.D.                        | Nom \$4.00 |
| Event 4 | 15 tgt 16 m Points C.D.<br>O/S and Jackpot. | Nom \$4.00 |

**Club Location:**  
6 km south of Euroa  
on Hume Highway.

President:  
John King

## SHEPPARTON CLAY TARGET CLUB

**Sunday November 5th**  
12.30 p.m.

- |         |   |            |
|---------|---|------------|
| Event 1 | 10 TGT DB EYE OPENER  | Nom \$2.00 |
| Event 2 | 20 TGT DB C'SHIP<br>Optional Sweep \$1.00.  | Nom \$5.00 |
| Event 3 | DB HANDICAP<br>1st, 2nd, 3rd & Back Marker.<br>Optional Sweep \$1.00.<br>Damien Doncon Memorial<br>Team Shoot<br>in conjunction with Event 2. | Nom \$5.00 |

OTHER EVENTS TIME PERMITTING

Afternoon Tea & Cartridges On Sale.

Secretary: G. Trevaskis.  
Phone (058) 27 1236.

**VICTORIAN, 13-9-78** — Very cold, some showers (65). 15t SB Hcp: D. Hill 15-15, J. Fortunato 30-32, R. Kydd 19-21. 15t DB Ch: R. Spicer 32-32, D. Nielsen 31-32, G. Went 26-27; FM G. Freeman 25-26.

**WARRACKNABEAL, 26-8-78** — Fine (30). District SB Ch: 'A' & OA David Flavel 21-22, Ken Miller 20-22; 'B' Cyril Budde 20-22, Graeme Stanes 20-22; 'C' J. Taylor 16-20, Graeme Goodall 20-25. \$50 Cash Hcp: divided between Peter Hewitt, Graeme Goodall and Laurie Dowsett all 15-15.

Quite a good roll-up considering the State Eliminations were being held at Bendigo. Skeet proved a success after the program was held and some good practice scores were shot. Congratulations to David Flavel who won the Single Barrel and went on to Kaniva to collect his second sash for the weekend in the Silent Rise Championship.

**WARRACKNABEAL, 23-9-78** — (37). Club 30t DB Ch: 'A' & OA Ken Miller 73-73, John Witney 72-73; 'B' Wayne Merrett 48-49, John Clark 47-49; 'C' W. Livingstone 32-33, Alf Facchin 29-30. 15t Cash Hcp: Wayne Merrett, Phil Scott, Graeme Goodall, John Clark and Peter Pendlebury all 15-15 divided.

Quite a good roll-up even though other big shoots were being held in the area. Plenty of time enabled 20-odd shooters to have a round of Skeet each. Club wishes to congratulate Wayne Merrett on his 50-break. Bad luck "Killer" on not hitting the 75 straight, better luck next time.

**WARRNAMBOOL, 9-9-78** — Fine, slight wind (40). Western District DB Ch: Wayne Storer 29-29 (Hamilton), Bruce Jennings 28-29 (W'beal), M. Holloway 27-28 (W'bool). 15t Hcp: H. Squires 27-27, L. McDonald 26-27, D. Jacobs 25-26; 11-13m C. Featherstone (Tyrendarra), D. Higgins (W'bool); 14-17m L. Storer (Hamilton); 18 and over metres F. Taylor (Mt Gambier).

This was a very good attendance for Warrnambool. Congratulations to Wayne Storer for taking out the Championship and very good shooting by Henry Squires in the Handicap. Good to see Bob Thatcher down from Korumburra again. Many thanks to all those shooters who attended our shoot.

**WEDDERBURN, 24-9-78** — Fine, sunny (36). 10t DB EO: nine shooters shot the possible 10-10 Glen Rose, R. Saunders, L. Knight, N. Napier, A. Turner, M. Ritchie, F. Doyle, O. Allison, C. Reid. Miss Australia Charity Shoot, Julie Reeves 20t DB Hcp: Mark Richie 30-30, O. Allison 29-30, R. Cross 23-24. Individual prizes for this Shoot. 11m C. Reid, 12-14m C. Dooly, 15-17m B. Amy, 18-20m N. Napier 21-23m K. Burton, 24-25m C. Knight. 20t SB Ch Graded: 'A' C. Knight 17-20, K. Burton 15-20; 'B' R. Ross 18-20. A. Turner 17-20; 'C' L. Knight 19-20, C. Dooly 16-20. Ladies Shoot 10t DB: winner Mrs S. Amy 9-10.

Magnificent day for shooting. All events were very keenly contested. Good scores were shot by all. All prizewinners were very pleased on receiving a kiss from our Miss Australia entrant, Julie Reeves.

# MILDURA CLAY TARGET GUN CLUB

(Affiliated with A.C.T.A.)

## SATURDAY 2nd DECEMBER

### Heley & Mills Outdoor-Traders SOCIAL DAY

Open to all registered shooters and newcomers, and their families.

Plenty of Shooting  
BBQ TEA

Full Details in December issue of CTSN.

Sec.: L. G. CONNORS,  
P.O. Box 19,  
Mildura. 3500.

# SEBASTOPOL GUN CLUB — BALLARAT

SUNDAY, 19th NOVEMBER

Noms. 12.30 p.m.

## S.K.B. TEAM SHOOT

with the assistance of Michaelis Bayley Trading.

Event 1 5 Target Practice for Event 2 Free

Event 2 25 tgt S.K.B. DOUBLE BARREL CHAMPIONSHIP Nom \$8.00  
16 metres — \$500 trophy value.

Overall winner — Sash and Cougar Bonanza BBQ with cylinder (\$102) PLUS 1st each Grade — Sash and Cougar Calgary 2 burner gas stove with cylinder (\$78). 2nd each Grade — Cougar Eildon Sleeping Bag (\$25). 3rd each Grade — \$15 Trophy. Optional Overall Sweep 50 cents.

### S.K.B. TEAM EVENT

in conjunction with Double Barrel Championship. Teams of five from country clubs from south-western Victoria (not restricted to Zone). Winning Club has the right to conduct this event in 1979 and each team member will receive a memento medallion. Event 3 Free

Event 4 5 target Practice for Event 4 Nom \$7.00

### 25 Tgt HANDICAP (1000 Cartridges)

1st 500 cartridges. 2nd 250 cartridges. 3rd 150 cartridges; 19-25m 100 cartridges.. Optional Overall Sweep 50 cents.

PLEASE BRING YOUR HANDICAP CARD.

President: N. J. Paterson.

Phone (053) 35 9268.

AFTERNOON TEA.

Vice-President: B. Brooks.

Phone: (053) 31 4826.

# VICTORIAN CLAY TARGET ASSOCIATION

PRESENTS

## STATE SKEET CARNIVAL

DATE: NOVEMBER 10, 11, 12.

DATE: NOVEMBER 10, 11, 12.

LOCATION **MELBOURNE** GUN CLUB 4 grounds

PRACTICE — THURSDAY 9th, commencing 12 noon

Event 1

**FRIDAY 10th — commencing 9.30 a.m.**

Nom \$10.00

**50 T State SKEET Championship**

Graded A 0, B 1-3, C 4-10. O/A WINNER: Sash & Trophy. GRADE WINNERS: Ribbon & Trophy. Trophies 2nd each grade. Trophy Best Lady, Best Junior 16 years and under. ALL TROPHIES KINDLY DONATED BY WINCHESTER VICTORIA.

Event 2

**50 Tgt Blue Dot SKEET Carnival Championship**

Nom \$10.00

Graded A 0, B 1-3, C 4-10. O/A WINNER: Sash & Trophy. GRADE WINNER: Ribbon & Trophy. Trophies 2nd each Grade. Trophy Best Lady. Best Junior 16 years and under. DONATED BY BLUE DOT TARGETS.

Event 3

**SATURDAY 11th — commencing 9.30 am**

Nom \$10.00

**50 Tgts State SKEET Team Elimination**

Top 15 scores to comprise State Team. Prize money C/D.

to be followed by

**STATE SKEET TEAM MATCH 50 TARGETS**

High Gun Sash & Trophy kindly donated by R. Buchan.

Ladies Skeet Team Elimination will be conducted in conjunction.

Event 4

**50 Tgt Vic-NSW SKEET Chall. Ch.**

Nom \$10.00

Graded A 0, B 1-3 C 4-10. O/A WINNER: Sash & Trophy. Grade Winners: Ribbon & Trophy. Trophies 2 each grade. Trophy Best Lady. Best Junior. ALL TROPHIES KINDLY DONATED BY ELEY VICTORIA.

**SUNDAY 12th — commencing 10 a.m.**

Event 5

Nom \$10.00

**50 T SKEET Comm. Championship**

Graded A 0, B 1-3 C 4-10. OVERALL WINNER: Sash & Trophy. GRADE WINNER: Ribbon & Trophy. Trophies 2nd each Grade. Trophy Best Lady. Best Junior. ALL TROPHIES KINDLY DONATED BY ELEY AUSTRALIA.

Victorian Zone Skeet Team Premiership will be held in conjunction with above event. Each Zone is allowed 2 teams of 5 shooters.

HIGH GUN: Sash & Silver Goblets conducted over advertised program.

**SPECIAL NOTE:** Shooters must produce Registration Cards which must be correctly endorsed with all SKEET performances.

VICTORIA v N.S.W. TEAM CHALLENGE will be over Events 2 3 4 5. Each State allowed any number of 5 man teams. Victoria teams selected over Event 1. Trophies for these teams events have been donated.

**FRIDAY NIGHT 7 P.M. — The VCTA will discuss formation of a SKEET organising committee. All shooters are welcome.**

**BBQ TEA & SOCIAL GET-TOGETHER SAT NIGHT 11th**

Caravan & Camp sites available at the Club Grounds.

R. Buchan, President V.C.T.A.  
Phone 870 5459. Bus Hours 541 1188.

T. Nash, Secretary V.C.T.A.  
P.O. Box 86, Mitcham 3132.  
Phone 615 1105.

Refreshments, Luncheon available on Ground.

## PUCKAPUNYAL AREA ARMY GUN CLUB SUNDAY 26th NOVEMBER

start 12 midday

- Event 1 Nom Free  
**CHAMPION OF CHAMPIONS**  
 Open to all overall winners of Championships during  
 1978 at Puckapunyal.
- Event 2 Nom \$4.00 each  
**20 PAIR DEAUVILLE DOUBLES**  
**CHAMPIONSHIP**  
 Sash and Trophy for first pair,  
 Trophy for 2nd pair.
- Event 3 Nom \$5.00  
**20 TGT HANDICAP**  
 Trophies for 1st, 2nd & BM

-----  
**PLEASE NOTE: Change of program as ad-  
 vertised in the VCTA Book.**  
 -----

Afternoon Tea & Full Refreshments  
 Available.

**The Club also shoots every  
 Wednesday afternoon, start 1.30 p.m.**

SSGT J. POWELL,  
 Secretary,  
 Armoured Centre TSS  
 Puckapunyal Ph (057) 937492  
 A/H 922324.

**WERRIBEE, 10-9-78** — Fine, light winds (101). 20t DB Hcp: overall winner B. Scotta 66-66; 11-15m N. Guida 55-56; 16-20m K. Calder 65-66; 21-25m W. Williams 25-26. 15t Trufflite DB Graded Ch: 'A' & OA winner W. Iles 78-78, 'B' P. Radoa 77-78; 'C' F. Scotta 46-47. Ladies Trophy won by S. McChrystal 15-17.

**WOODS POINT, 24-9-78** — Fine (34). 5t EO Pts Hcp: N. Stovell, M. Flack, R. Legg, J. Anderson, G. Botten equal 1st. 10t SB 16m: N. Stovell 19-19, B. Rogash 18-19, G. Botten 12-13. 20t DB 16m: J. Anderson 20-20, J. Doyle 32-33, D. Woods 31-33. 10t Tower Novelty: L. Gray 25-25, J. Doyle 24-25, J. Wood 14-15.

Ten members of Melbourne Metropolitan Fire Brigade Gun Club competed again for the Shield based on scores shot in the 20t DB 16m event. Woods Point retained the shield with a score of 173 to 155.

## ST. JAMES GUN CLUB XMAS SHOOT

### Saturday 9th December

Seasonal Trophies

Pres: P. Pettit.

Sec.: M. Murphy.  
 (057) 64 4325.

## VENETO SOCIAL CLUB SHOOTERS



## SUNDAY 19th NOVEMBER

at the Melbourne Gun Club,  
 Victoria Rd., Lilydale

- Event 1 Nom \$5.00  
**20 T ELEY DB C'SHIP**  
 Graded A B C — 1st & 2nd each grade.
- Event 2 Nom \$5.00  
**20 T ELEY DB HCP**
- Event 3 Nom \$6.00  
**25 T ELEY GRADED  
 TRENCH C'SHIP**  
 Graded A B C.

Refreshments & Cartridges Available at Ground.

**Please Note that the date of the Christmas Shoot  
 has been changed to 3rd December. Full details  
 next issue of Shooting News.**

President:  
 F. Spinosa,  
 24 Sandra Street, Bulleen.  
 Phone 850 5586.

Secretary:  
 R. Brida,  
 16 Valerie Street,  
 Lower Templestowe.  
 Phone: 850 8235.

## TATURA GUN CLUB

(Affiliated A.C.T.A.)

## SUNDAY NOVEMBER 19th

start 12.30 p.m.

- Event 1 Noms close 1 p.m.  
**10 TGT EYE OPENER**  
 Standard Targets.
- Event 2  
**30 TGT VIC STATE DB  
 MINI TGT C'SHIP**
- Event 3  
**15 TGT TROPHY HCP**  
 Standard Targets.

Afternoon Tea  
 Cartridges Available.

President:  
 F. Crawford.  
 Shepparton 21 2774.

Secretary:  
 A. Moles.  
 Tatura 24 1538.

# FRANKSTON-AUSTRALIAN GUN CLUB

ROSSITER ROAD, CARRUM DOWNS

President: Gordon Morgan  
Phone (Bus) 932366.  
(Private) 7929057.



Secretary: R. G. Learmonth.  
36 Petronella Ave.,  
Wheelers Hill.  
Phone 561 2484

## NOVEMBER

## PROGRAM

### SUNDAY NOVEMBER 5th

Event 1	10 TGT LANGWARREN POINTS GRADED CHAMPIONSHIP	Nom \$3.50
Event 2	15 TGT LANGWARREN DOUBLE BARREL GRADED CHAMPIONSHIP	Nom \$4.50
Event 3	15 TGT LANGWARREN SINGLE BARREL GRADED CHAMPIONSHIP	Nom \$4.50
Event 4	10 TGT D/B HANDICAP. Trophies 1st 2nd 3rd & Back Marker	Nom \$3.50
Event 5	25 TGT LANGWARREN SKEET CHAMPIONSHIP (Open & Restricted Grades)	\$5.00

★ Event 1 2 3 & 5 full Sash & Trophy for Overall winners,  
Ribbon & Trophy for Grade Winners, Trophies for 2nd each Grade.

### SATURDAY NOVEMBER 11th

SEE SEPARATE ADVERT. IN THIS BOOK FOR SPECIAL BIRTHDAY ANNIVERSARY SHOOT.

### SUNDAY NOVEMBER 12th

Event 1	10 TGT MOUNT ELIZA POINTS GRADED CHAMPIONSHIP	Nom \$3.50
Event 2	15 TGT MOUNT ELIZA D/B GRADED CHAMPIONSHIP	Nom \$4.50
Event 3	15 TGT MOUNT ELIZA S/B GRADED CHAMPIONSHIP	Nom \$4.50
Event 4	10 TGT D/B HANDICAP. Trophies 1st 2nd 3rd & BackMarker	Nom \$3.50

★ Events 1 2 3 full Sash and Trophy for Overall winners,  
Ribbon and Trophy for Grade winners, Trophies for 2nd each Grade.

### SUNDAY NOVEMBER 19th

Event 1	10 TGT CRANBOURNE GRADED POINTS CHAMPIONSHIP	Nom \$3.50
Event 2	"LORD BIRDWOOD CUP" 15 TGT D/B HANDICAP	Nom \$7.00
	First Perpetual Cup and Trophy, Trophies for 2nd & 3rd and Yardage prizes.	
Event 3	10 TGT CRANBOURNE D/B GRADED CHAMPIONSHIP	Nom \$3.50
Event 4	10 TGT CRANBOURNE S/B GRADED CHAMPIONSHIP	Nom \$3.50
Event 5	25 TGT CRANBOURNE SKEET CHAMPIONSHIP (Open & Restricted Grades)	Nom \$5.00

★ Events 1 3 4 5 full Sash and Trophy for Overall winners,  
Ribbon and Trophy for Grade winners, Trophies for 2nd in each Grade.

### SUNDAY NOVEMBER 26th

Event 1	10 TGT PATTERSON LAKES GRADED POINTS CHAMPIONSHIP	Nom \$3.50
Event 2	15 TGT GROUP YARDAGE HANDICAP 11-15 16-20 21-25	Nom \$15.00
	AUTOMATIC SHOTGUNS for 1st in each Group. Tin powder for 2nd in each Group.	
Event 3	10 TGT PATTERSON LAKES D/B GRADED CHAMPIONSHIP	Nom \$3.50
Event 4	10 TGT PATTERSON LAKES S/B GRADED CHAMPIONSHIP	Nom \$3.50
Event 5	25 TGT PATTERSON LAKES SKEET CHAMPIONSHIP (Open & Restricted)	Nom \$5.00

★ Events 1 3 4 5 full Sash and Trophy for Overall winners,  
Ribbon and Trophy for Grade winners, Trophy for 2nd in each Grade.

—— OTHER EVENTS TIME PERMITTING ON ALL SHOOT DAYS ——  
Full Canteen Facilities Available from 11.30 a.m.; Cartridges, etc., always available.

COMING MAJOR EVENTS:— 10th December, WINCHESTER TOURNAMENT; 17th December, GALA XMAS SHOOT.

Family Barbecue & Social Night : Saturday 4th November, from 6.30 p.m.  
BBQ, BYO Food & Drinks Music, Dancing, etc. Everyone Very Welcome.



# BOORT CLAY TARGET CLUB SUNDAY 12th NOVEMBER

- (commencing 12 noon)
- |         |   |            |
|---------|---|------------|
| Event 1 | 10 TGT DB E/O 16m   | Nom \$2.50 |
| Event 2 | 20 TGT WINCHESTER<br>D.B. C'SHIP 16 m<br>1st, 2nd, 3rd, F/M.<br>Opt Sweep \$1.00. | Nom \$5.00 |
| Event 3 | 10 TGT DB HANDICAP<br>TROPHY<br>1st, 2nd, 3rd.                                    | Nom \$3.50 |
| Event 4 | 10 TGT DB HANDICAP  | Nom \$3.00 |

TIME PERMITTING  
Sweepstakes.

President:  
E. Lanyon.  
Boort. 245U.

Secretary:  
N. Featherby.  
Boort 281

# NEPEAN GUN CLUB BONEO ROAD, FINGAL. Grand Opening SATURDAY 18th NOVEMBER 12 P.M. SHARP

A.C.T.A. Cards must be Presented)

- |         |  |            |
|---------|--|------------|
| Event 1 | 10 TGT PTS CD E/O  | Nom \$3.00 |
| Event 2 | 20 TGT DB<br>OPENING C'SHIP GRD.<br>A B C Ribbon & Trophy,<br>2nd each Grade.  | Nom \$6.00 |
| Event 3 | 15 TGT HANDICAP<br>1st 2nd 3rd.<br>TROPHY VALUE \$50, \$30, \$10.<br>Clay Targets Donated by Blue Dot<br>HIGH GUN EVENTS 1 2 3 | Nom \$4.00 |

**Club shoots 3rd Saturday each month.**

Pres: N. Quick  
(059) 853580.

Sec: A. Neve.  
(059) 888532.

c/o P.O. Box 129 Rye 3941.

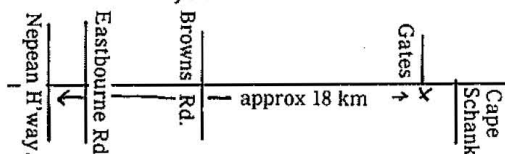

## SWAN HILL/NYAH GUN CLUB Saturday November 11 CANCELLED in lieu of WINCHESTER TOURNAMENT at Kerang

-----  
**Saturday November 25th  
LEGACY DAY**  
10 TGT 16 m S/S  
SWAN HILL LEGACY DB CH.  
10 TGT SB TOWER S/S  
LEGACY SKEET C'SHIP  
1.00 p.m. start.

Sec.: R. Canny.

## KORUMBURRA GUN CLUB Saturday 25th November at 11 a.m.

### ANNIVERSARY SHOOT

- |         |  |            |
|---------|--|------------|
| Event 1 | 10 TGTS POINTS   | Nom \$2.50 |
| Event 2 | 15 TGT DB<br>ANNIVERSARY HCP                               | Nom \$8.00 |
| Event 3 | 20 TGT DB C'SHIP<br>11-15, 16-20, 21-25<br>1st each grade. | Nom \$5.00 |

Winchester \$50 High Gun  
over day.

Secretary: K. Brown,  
Inverloch Road,  
Kongwak,  
Phone (056) 57 4263.

# ELEY TEAMS FINAL held at Bendigo Gun Club 28th August, 1978

The third and final day of a very successful Victorian State Trap Carnival saw the conclusion of the first series of the ELEY Teams Premiership Match. With teams being represented from the four zones of our State. The teams to shoot-off for the name of Premier Club of Victoria were:

**NORTH WEST ZONE:**

Mildura Gun Club, Jeparit Gun Club

**NORTH EAST ZONE:**

Bendigo Gun Club, Echuca Gun Club

**SOUTH WEST ZONE:**

Sebastopol Gun Club, Hamilton Gun Club

**SOUTH EAST ZONE:**

Morwell Gun Club, Frankston Australian Gun Club

The shoot off was held in conjunction with the ELEY Victorian Club Premiership Points Score Championship. Each Club to shoot 20 targets points scoring over four traps. With the points tallied it was found that the Bendigo Team and the Morwell Team locked together with a score of 283/300 each. A shoot off got under way with each team shooting five targets points — a maximum of 75 points per team. Bendigo were first to shoot and the boys really made a show of it. After the last target was shot, they had the remarkable score of 75/75 to their credit. Good shooting gentlemen!

Next the Morwell boys went up to the line with a pretty large task in front of them. After a fine attempt however the Bendigo boys proved too strong on the day. All teams are to be congratulated on the sportsmanship and shooting skills as there is a fair amount of pressure on team members, shooting for prizes in excess of \$1,000 for their Club.

With the honour of being called the Premier Club of Victoria, Bendigo Gun Club received the magnificent trophy of a Franchi Dragon Trap Gun, a case of cartridges and the J. Newton Thomas Perpetual Trophy.

Each team member of the winning team won a case of cartridges. For their fine shooting each top Club in the zone won a case of cartridges.

The winning club in each zone was Mildura, Bendigo, Sebastopol, Morwell Gun Club.

In conjunction with the ELEY Teams Premiership the final of the aggregate points championship was shot off between Bruce Dawe, R. Bull, P. Torok and Brian Rafferty. Brian Rafferty added to his magnificent winning run over the carnival and proved too strong taking out the points section to win the Franchi Automatic gas operated shotgun. Good shooting and congratulations Brian.

The handicap shoot off was then conducted with shooters, K. Smith, J. Sheppard, J. Whittaker, G. Timma, P. Edmondson, and M. Potter taking their marks to win the Franchi 500 gas operated shotgun.

The young up and coming clay buster from Sebastopol, Peter Edmonston shot strongly in a very good field and ended the victor. Congratulations Peter, hope we see you in the winner's circle more often.

The overall aggregate over all events carried the prize of the top grade Franchi "Eldorado Gold" 5 shot gas operated Auto. A gun to be treasured a lifetime went to Bruce Jennings from the Maryborough Gun Club. Bruce shot the remarkable score of 159/160 over all events. Truly great shooting Bruce and our hearty congratulations.

ELEY would like to thank all shooters and Clubs for their support through the year. Special thanks to the President and Committee at Bendigo Gun Club for the work put into making the State Carnival successful, to the President and Executive of the Victorian Clay Target Association for allowing us to sponsor and conduct the ELEY teams shoot off in conjunction with the State Carnival and to George Breman, Shoot Marshal, for his most efficient work.

We hope to see you all back next season in full force as rewards will be high to the successful Clubs and Competitors.  
Good Shooting. ELEY.

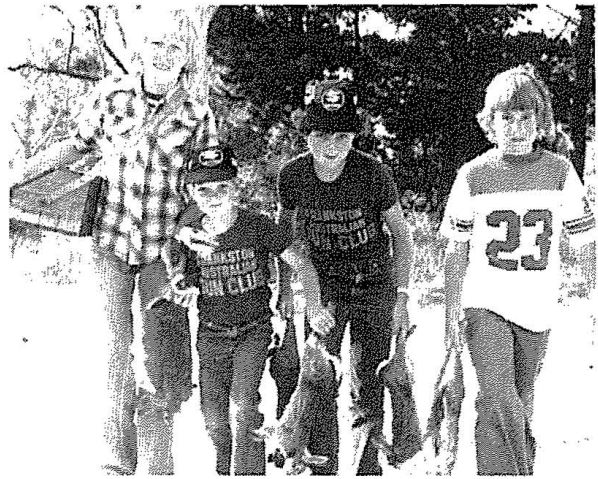

● The family interest in the Eley Premiership is demonstrated by these Junior Shooters — From left: Ricw. Borner, Brian and Kevin Garth, and Gary McGillivray, after a days ferreting.



● Dennis Kidd, Mornington Clay Target Club, after winning the Eley Championship at Korumburra Gun Club. (Photos by Tom Gannon).

## Vic. State Association News (Cont'd from page 32)

Answer —

I'm sure we all realise that if we want to do anything really well, we must learn to do it properly. In other words, there is a right and wrong way of doing all things. Therefore, we must understand and practice the basic fundamentals that are involved. We should practice the basics until they become an automatic reflex action.

Following are the important basics:

1. GUN SELECTION AND PROPER GUN FIT.
2. CORRECT GUN ALIGNMENT.  
Moving the gun along the same flight paths as target.
3. PROPER GUN HOLDING.  
Hands and shoulder position.
4. SWING THROUGH AND LEAD.  
Shoot ahead of the target, not at it.
5. CORRECT STANCE.  
Body in balance.

There are other important things we must develop as we progress, such as concentration and mental approach etc., but these details come along later.

Victorian clubs in all zones can now contact their zone coaches when they wish to stage local coaching classes. Or contact me direct c/o A.C.T.A. office if you wish.

Good Shooting . . .

GEO. BIGGS,  
State Coaching Director.

# The 1978/79 Season Opens at Kerang

from Chris Penno

On 19th August 1978 the Kerang Clay Target Club held their opening shoot for the 1978-79 season with a day and night program which included the Commonwealth Deauville Doubles at night.

Eighty-three shooters competed in the day program which was shot under very good conditions considering the very poor weather which had been experienced right up until the day before when it had rained much of the day. The next day, Sunday it was raining again.

The first event on the program was the Roby Manuel Memorial Championship. Although there were only eight possibles in this event there were a further 40 shooters who shot either 18 or 19. In the shoot-off which followed A Grade and O. A was won by Stan Kerr from Kerang with a score of 47-47. Stan was very happy to win this event as in years gone by he had shot with the late Roby Manuel, and was runner-up in this event last year. Second in A grade went to B. Wagg from Kaniva with 46-47. First in B grade was Don Dunn from Warracknabeal with 36-36 whilst his clubmate P. Hewitt was second with 35-36. C grade was won by Greg Veith from Bendigo with a score of 25-25. Second in this grade was John Dee from Kerang with 24-25.

Following the championship was a 20 target handicap event with an automatic shotgun as first prize. There was 16 possibles in this event ranging from Colin Knight from Bendigo on 24 metres and Eric Hall from Kaniva on 23 metres right through to frontmarkers. The final winner of the event was Eddy Parker from Swan Hill with a score of 41-41. Second was Ron McKnight from Ararat with 40-41. Third placegetter was B. Papst who scored 39-40. The frontmarker trophy was won by S. Larcombe from Echuca with 30-30. Eric Hall from Kaniva was a little unlucky not to win one of the main trophies but won the backmarker trophy with a score of 37-37.

The ladies provided a salad tea with soup and sweets which kept the shooters quiet for a while. Although a number of the shooters left after the day program quite a number of the big guns turned up for the night event.

The first event on the night program was a six pair deauville doubles eye opener shot off 24 metres. In this event there was only one possible which was shot by the father and son team from Ballarat in Norm and David Patterson. Six pair of shooters shot 5-6 in the eyeopener.

Following the eyeopener was the Commonwealth Deauville Doubles Championship which was also shot off 24 metres. It wasn't long before the first squad returned to the clubrooms and a score of 19-20 appeared on the scoreboard. This was shot by Ray Honeychurch and Syd Gerry from Bendigo. This was a very creditable score and set quite a task for the remaining shooters. Ray and Syd spent the remainder of the evening wandering around impatiently with worried faces. They need not have worried as the next best score for the entire event was 17-20 which was shot by the Pattersons from Ballarat and also by Lindsay Jobling and Colin Knight both from Bendigo. Ray and Syd won their blue sashes the easy way. The shoot-off for second place lasted one pair and was won by Knight and Jobling with 18-21.

This left one event, the 15 target handicap sweepstake. As there were 10 shooters at this stage all 1 down in the high gun with scores of 39-40 it was hoped that this event would provide an outright winner otherwise a shoot-off would be necessary. Six possibles resulted in this event. They were Jim Allison from Boort and Drew English, Tony Hill, Arthur Stevens, Rex Peacock and L. Dehne all from the Kerang Club, As Arthur Stevens was the only shooter on 39-40 to shoot the possible it meant that he had won the high gun sash donated by our president Frank James with a very creditable score of 54-55.

The Kerang Club would like to thank all shooters who attended and all those who helped in any way to make this a very successful shoot. We would also like to see all those shooters who attended bringing their friends with them when we conduct our Winchester Tournament on the 10th and 11th of November. ○

## More pics from V.C.T.A. Carnival.



● Ken Lowry will go to any lengths to advertise his Company's products. Here Blake Lowry demonstrates the quality of Winchester packs.



● Here is the popular Secretary of the Victorian Clay Target Association, Trevor Nash with friend, Karen Williams after a win in a Ladies Event.



● A popular Ladies winner, Sue Lowry.



● Deserie Wakefield winner of the High Gun Award, Ladies Trap Team 1978.

## AN UNCONVENTIONAL FERRET

The following letter has been received from David Hillan, Secretary of the Australian Shooting Association . . .

"I am enclosing two photographs of my Ferret which I use for rabbits. You will see it is different from the conventional Ferrets used by most rabbiters, as this one depends on its 30 calibre Browning. The way the rabbits are developing these days, getting bigger and stronger, it probably won't be long before this is a necessary part of the rabbitier's equipment, as they get rather ferocious if they are only wounded. I am in the process of repainting it so that it is better camouflaged.

"It is powered by a six cylinder Rolls Royce Motor and has a Daimler 5 speed Pre-Selector Gear Box. To date it has only done 7,500 miles even though it is 22 years old. No doubt the low mileage is because the Defence budget could not afford the maximum economy it produces of six miles to the gallon."

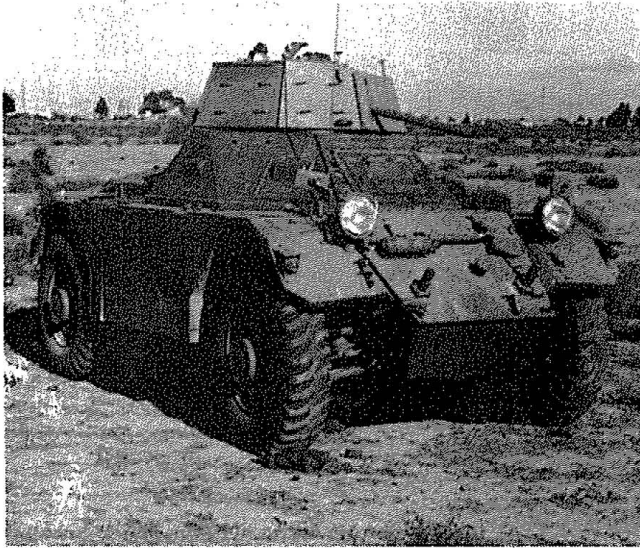

• The "Ferret"

## How to Cover Trap and Skeet Shoots . . .

As a follow-up to the article on page 84 of October C.T.S.N., the Remington Arms Company offers this advice.

Reporting on local trap and skeet shoots doesn't require that one be an active clay target competitor himself nor even that he attend the shoot. But it does dictate some understanding of the rules and nature of the sports and the descriptive terminology used.

Outdoor or sports writers who are familiar with trap and skeet can report shoots by either dropping by the host club at the end of the competition or by arranging for someone at the host club to call in the results by phone. A little salesmanship by the writer with his sports editor or editor-in-chief might even pry loose a staff cameraman to photograph winners of major shoots such as state or zone championships.

All that is needed in such a situation is for the writer to learn the location of clubs in his immediate area that run registered shoots and then contact the club secretary or shoot chairman for the dates of scheduled shoots. That same individual may often be most happy to call in results of shoots the writer can't attend.

If a writer isn't sure of the existence or location of clay target clubs that hold competitive shoots in his area, he can obtain such information by writing to the Australian Clay Target Association, G.P.O. Box 2038S, Melbourne 3001.

Simply provide the name of the town or city in which your paper is located and ask for names and addresses of nearby clubs.

There are also a number of potential benefits to outdoor writers in becoming familiar with local clay target clubs. They can provide writers with an opportunity to shoot trap or skeet themselves

on an informal or competitive basis, a place to warm up his or her wing shooting before the beginning of hunting seasons, and, since some clay target clubs also have outdoor rifle and pistol ranges, a place to practice with and sight-in both handguns and rifles. Many outdoor writers who perform both newspaper and free-lance magazine work on shooting subjects also find a nearby gun club an ideal place to conduct test work and set up article-related photography.

In summary, the outdoor writer who doesn't have a working relationship with a gun club when one exists nearby is missing a grand opportunity to build public recognition of the shooting sports and to further his or her own practical and first-hand knowledge of all shooting activities. ○

## Clay Target Sports offer unique, lifetime values

For some hunters, the end of winter brings temporary retirement of their rifles and shotguns until re-opening of game seasons the following fall.

Among many other shooters, however, spring kicks off an entirely new season of activity, a busy, interesting and challenging one to boot. These are the nation's legions of clay target shotgunners.

Various types of trap and skeet shooting form one of the largest participant sports in the United States. Participation ranges from simple weekend recreation to serious competition in officially registered shoots and on up to those training for the prestigious opportunity to represent their country in Olympic competition.

Those already involved in some form of clay target shooting are virtually unanimous on one point. The sport can be a lot of fun, with a variety of potential rewards.

Without question, one of clay target shooting's most attractive aspects is the fact that nearly anyone can become a participant, even a serious competitor, with few of the restrictions based on age, size, height or athletic prowess imposed by many other sports.

Another interesting exception is the European sport of soccer in which participation, particularly among youngsters, is growing rapidly in this country. A major factor in this growth is the recognition by parents, once they become familiar with the sport, that their children of average or less-than-average size and height can play at no disadvantage and minimal chance of serious injury.

Non-shooting parents, who may have had reservations about allowing their children to get involved in shooting sports, have also been pleasantly surprised to discover that sports such as trap and skeet are among the safest known and provide youngsters with an excellent platform for personal satisfaction and development of maturity and self-confidence.

A built-in bonus of clay target shooting is the fact that these are lifetime sports, a recreational outlet that won't be shut off when participants complete schooling or reach a certain age. Major clay target championships are won periodically by both teenagers and veteran shooters several times the age of the youngsters. In addition, trap and skeet are enjoyed by many people with physical handicaps that preclude participation in most other sports.

Getting a beginner started in clay target shooting can be relatively simple. Most sportsmen's clubs have shooting programs with competent instruction and help for beginners of all ages. They are usually most happy to obtain new members and have others join their shooting ranks.

Frequently, clay target shooting becomes a family affair, presenting a rewarding opportunity to maintain a common area of activity. Parent and child and husband and wife clay target partnerships are numerous.

What's the best time to introduce beginners to clay target shooting? Anytime is good, but spring is possibly best and that's right now. Anyone interested in obtaining the name and address of a clay target club nearest to them can write to any member of the Executive Committee of the Australian Clay Target Association or the National Secretary-Manager, G.P.O. Box 2038S, Melbourne, 3001. ○

(Remington Newsletter --- Mar/Apr '78)

# SHOOTERS CROSSWORD

## ACROSS

1. The basis of our sport.
7. The first event (inits).
8. First name of High Gun winner 1978 Championships.
9. Happy facial expression.
10. Appendage.
13. First name of past president.
16. Under.
18. Some say it is the best shooting of all.
19. Left hand.
21. Hop drying kiln.
23. Inits. of a club in N.S.W.
25. Longest break trap record holder.
29. Winner of Sth. Pacific games skeet Gold Medal (inits.)
31. Make oneself likeable.
33. Three times Australian skeet title holder.
34. The dreaded word.
35. Thus
36. Country Bumpkin.

## DOWN

2. Shelter given by object.
3. Shrill cry of anger.
4. Implication of intention.
5. Australian trench record holder.
6. 1978 Commonwealth games team member.
8. Held every year to decide the best.
9. Stipendiary Magistrate.
11. Disgust.
12. One of the old time greats (inits.)
14. Vandalia Country.
15. What the referee hopefully does when you call.
17. Alternative interational competition.

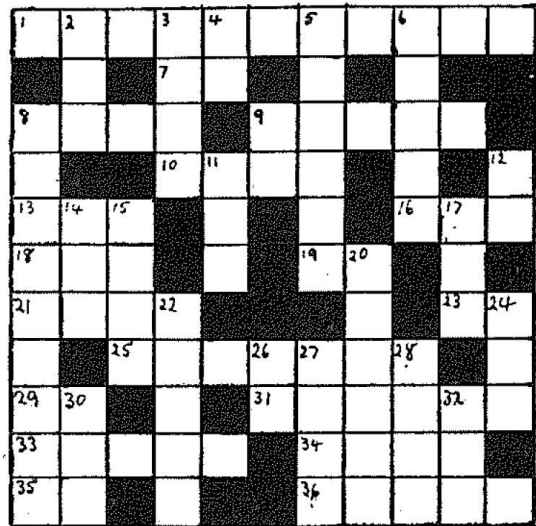

20. Witchcraft Spell (why you shoot badly at a particular venue).
22. Rends.
24. Conflict.
26. Us.
27. Exclusively.
28. Writing table.
30. Soft murmuring sound of doves.
32. Consumed.

## More Photos from Charity Shoot — Burnie Gun Club



● Phillip Turner of Devonport.



● Ian Rist in good form.

(Photos by courtesy of "The Advocate", Burnie)



● Kay Sanders, Miss Tasmania entrant, accepts a cheque for \$1080 from Burnie Gun Club President, Dr Paul Cains.



● Trevor Buckby, who unfortunately lost his leg in an accident soon after this match.

# GUN TALK . . .

Pat Browne

Let's continue our delve into the bits and pieces we have been discussing on the techniques of trapshooting. Of necessity we cannot go too deeply into all the ramifications in so short a column but I think we can kick around a few ideas that may make your life a little easier in the frustrating trapshooting game.

Little sayings that you pick up over the years have a lot of depth to them. I daresay you have heard a lot of them, but do you realise how much depth is in some of them. Let's look at a few and see whether they have any basis to have you believe they are true.

Try this one . . . the mug shooter will say he is going out to shoot 20 straight, the smart shooter says he is going to break the NEXT target. Oh, how true this statement is. In a coaching clinic I run at my local Gun Club the main thrust of my instruction is to get the novice to work on his technique with one overriding thought in his or her mind.

This is to master the basic techniques to be able to break each target individually as it is faced. To do this you need a single minded approach to these basic techniques and when they are mastered you can turn your attention to breaking good scores. BUT, the only way you will do it, is to break each target individually. Once you can get your mental side under control to do this you shift out of the all-so-ran class and into the championship class. It stands to reason that if you can divert all your mental capacity into breaking each target as an individual target, the final score will look after itself.

Try this one . . . I'll go in this event, but there are plenty of shooters here that can beat me." If I have heard this statement at gun clubs once, I have heard it a thousand times. I would give you a shade of odds that the fellow who made the statement didn't win. Negative attitudes in competition trapshooting would probably be the single biggest reason for missing targets and thus losing events.

Hark back to the previous paragraph where we were talking about the basic fundamentals. Trapshooting is not a game where you are competing against a field of other shooters, it is a game where you are matching your ability to master all the techniques required to break a fast flying clay target. You need all your physical and mental capacity to do this successfully. BUT, you cannot do it if you are worrying about every other bloke who is out there trying to do the same thing. You can bet your life that the fellow who wins the event was not worrying about you, he didn't have to, you had talked yourself out of winning before you started.

I well remember at the Nationals just recently, when talking to a top shot after he had run a very nice 50 straight in one of the events. He made the comment that he had noticed on the scoreboard that his arch rival had also shot 50 and . . . "that he is real hard to toss in a shoot-off." You do not win a prize for guessing who won the event.

The negative attitude displayed in that simple comment indicates that there is a flaw in the mental attitude to clay target shooting in that competitor's mind, that unless controlled, could become devastating. Confidence in your ability is not an ego trip, it is an attitude of mind that comes when you have done all the work on the basics and have worked on them to such a degree that you KNOW they will not let you down in the heat of competition.

Perhaps we could finish up this month by looking at this statement you quite often hear . . . "don't call for a target unless you intend to break it." This has a lot of meat in it. It means that you treat every target that you face as the only target you have to break. In simple terms, it comes back to the point that practice and competition targets are of equal importance. On the practice field or at practice sessions you might just as well not be there if you are not working on some facet of your game.

I could tell you how far you would get if you wandered onto the training field at North Melbourne and told Ron Barassi that you only came out to kick a few balls from end to end and you were not taking your football seriously at that session. It is only over recent years that we have begun to recognise that it needs a single minded approach to the shooting sports to get to the top. More importantly, we are starting to realise that shooting is a sport like any other sport with its just demands on the physical and mental resources of the competitor. In this context then, the competitive clay target shooter needs to approach his game with a plan of action that is going to improve his performance.

There is absolutely no way this will happen if there is a sloppy and ill defined approach to his or her training program. So, for every target that you call for there is only one result, to break it. If you do not break it, you have done something wrong. If you have done something wrong there must be something wrong in your technique. The practice session is the ideal place to iron out these flaws in your technique and this can only be done if you are taking each target you face seriously.

It took me a long time to realise this myself but now that I have learnt the lesson, I hammer it home to all who participate in my coaching clinic. At our sessions every target thrown is one that something can be learnt from. With this approach all agree and you would be amazed at the improvement shown when a shooter stops and analyses what went wrong when a target is missed.

So there it is, three common sayings that roll off the tongue whenever and wherever trapshooters meet. But behind these glib statements is a wealth of trapshooting experience. They were initially made by top gunners that have been through the mill and the advice contained in them if you examine them carefully and can grasp the meaning will do a lot for your game. THINK ABOUT IT, I am sure you will agree. ○

(Reprinted by courtesy of Australian Shooters' Journal)

## Editor's Mailbox (Cont'd from page 35)

shoots at a whole target, he accepts the result, whether it has an off beat trajectory, slow pull or fast pull. Something of this sort would not only make the life of a referee much easier, but would remove the reason for much of the dissatisfaction with the job that they do.

Yours faithfully,

A. D. MYLNE.

Sir,

Recent correspondence has connected the Ballandean Gun Club with comments in an earlier letter alleging dishonest refereeing.

If those comments concern the State Teams Elimination shot at Ballandean in May then a reply from us is necessary.

We wish to make the following points:

1. The weather on that occasion was so atrocious that no referees ever had more difficult conditions under which to operate.
2. For nearly 20 years no club has gone to more trouble than we have to preserve the equity of the competition and to maintain the highest standards of refereeing (this club has never yet allowed one referee to take one squad through a number of traps).
3. The referees for the above shoot were not chosen haphazardly but with great thought many weeks before the shoot took place. We believed they were the most competent available to us and that their integrity was beyond reproach.
4. Nothing has been brought to light to alter our opinion.
5. If we were choosing referees for a similar shoot now we would choose the same persons.

A. J. SMITH,  
President,  
Ballandean Gun Club.

## The Association's Youngest Member?



● Murray Calder was born on 19th September, 1978, and is already a registered shooter, Member Number 16908. He is shown here with proud parents, Carol and Keith Calder, of Melbourne.

# You & Browning. The ideal pair.

In a few seconds you will call for your "clay", and once again you will be appreciating the perfect balance, the ideal weight and the efficiency of your Browning gun. A gun carefully built by experts and designed to give you years of trouble-free shooting pleasure, even under the most demanding conditions.



MONTREAL

FOUR MEDALS :

GOLD - SILVER - BRONZE (SKEET & TRAP)



**SPECIAL SPORTING**—Nos. 205 & 206.

A gun specifically designed for Field and Game type simulated shooting. Available in two models—27½" or 30" barrels with a 12 mm Rib.

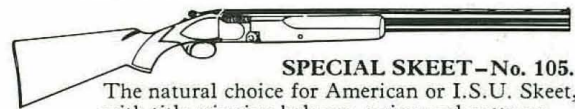

**SPECIAL SKEET**—No. 105.

The natural choice for American or I.S.U. Skeet, with title winning balance, swing and patterns. 27½" barrels, 12 mm Rib.

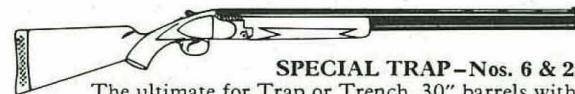

**SPECIAL TRAP**—Nos. 6 & 2.

The ultimate for Trap or Trench. 30" barrels with a choice of 12 mm or 16 mm Ribs.



## BROWNING®

Distributed in Australia and New Zealand by  
Winchester Australia Pty. Ltd.

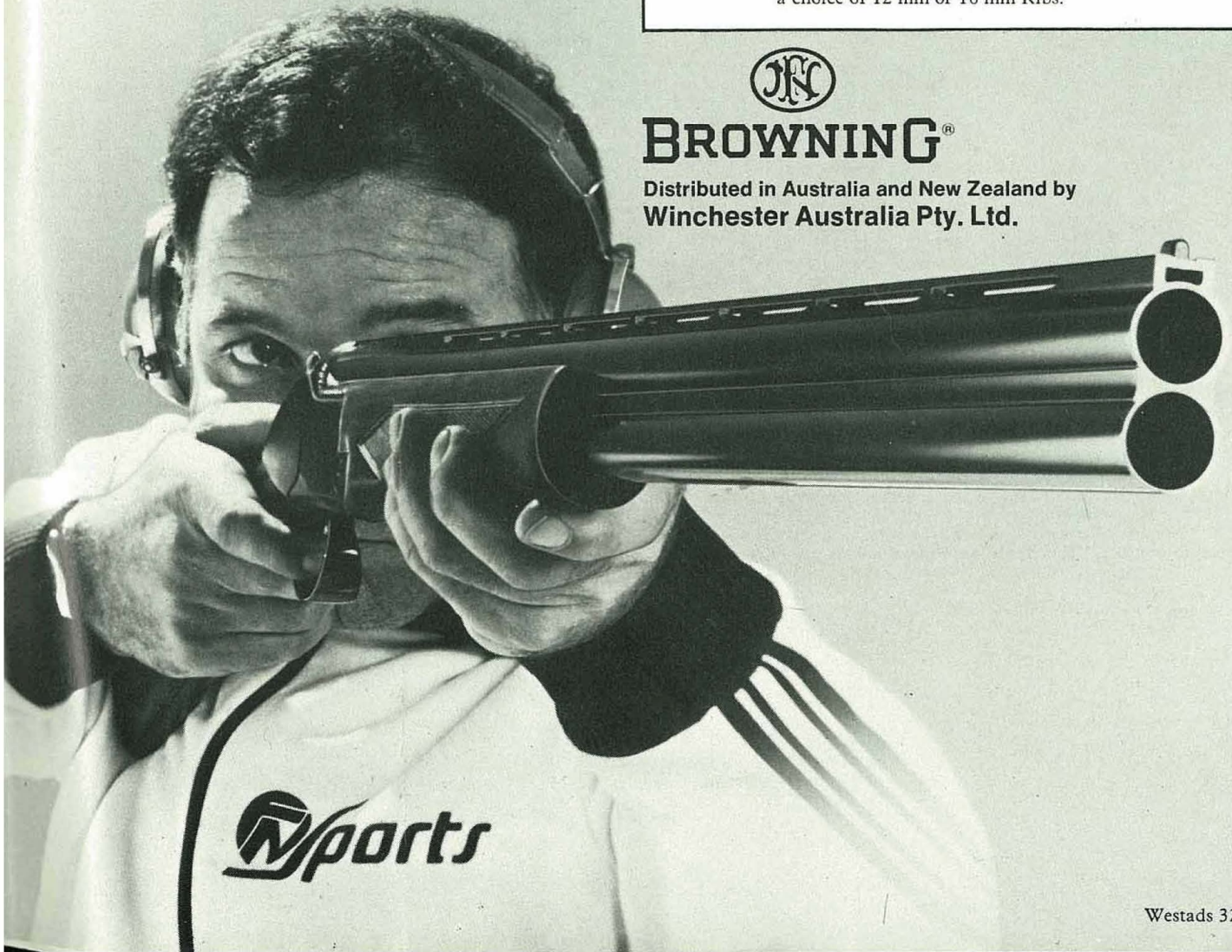



## This is 3 of our finest shotguns.

3 guns in one. Without the price tag.  
Winchoke lets you have one gun in your hand and two more in your pocket.

Changing patterns is easy. You're supplied with a quick-change wrench for the **Imp Cylinder** which is best used for close-in shooting (quail and skeet), **the Modified Choke** for medium range (rabbits and trap), or **Full Choke** for those 'impossible' shots you may care to mention to your friends.

Winchoke makes  
you a one gun shooter.  
Available for Winchester  
**Model 1200 Pump** or  
**1400 Semi Auto.**



**WINCHESTER**

More than a gun.  
A legend.

