



# AUSTRALIAN CLAY TARGET SHOOTING NEWS

OFFICIAL JOURNAL OF THE AUSTRALIAN CLAY TARGET ASSOCIATION INCORPORATED.  
REGISTERED BY AUSTRALIA POST—PUBLICATION No. VBQ 0129

AUGUST 1988  
Vol. 41. No. 8.



**AUSTRALIA'S BIGGEST SPONSOR  
OF CLAY TARGET  
SHOOTING**

**WINCHESTER**



# There is no such thing as an All Purpose Powder!



**THAT'S WHY HERCULES**

**MAKES RED DOT  
specially for Clay Target Competition**

## HERCULES RED DOT

### Calculate the savings yourself

17.5 grain loads	880	22 grains loads	699
18 grains loads	853	23 grains loads	668
18.5 grains loads	831	23.5 grains loads	653
19 grains loads	809	24 grains loads	640
20 grains loads	770	26 grains loads	591
21 grains loads	732	27 grains loads	569

The above table shows approximate number of reloads per kilo for grains used. \* 18.5 grains of RED DOT gives a 3 dram equivalent. 17.5 grains of RED DOT makes an excellent 2¾ dram equivalent load.

### OTHER GREAT HERCULES POWDERS

- GREEN DOT — Use in 12G medium and field loads
  - RELOADER 7 — Bench Rest grade rifle loads
  - BULLSEYE — For pistol and revolver use
  - UNIQUE — An all-round shotshell powder
  - 2400 — Some rifle and shotgun loads
  - BLUE DOT — Magnum shotshell and heavy pistol loads
  - HERCO — Heavy shotshell or handgun loads
- USE ONLY AS PRINTED IN THE HERCULES GUIDE.

If you reload to save money, you use HERCULES for the cost saving. Isn't it just as important to use the very best clay target powder available?

## INSIST ON RED DOT

It's made precisely for target competition and priced to give you up to 50% More Shots for your Dollar

HERCULES Powders are stocked by selected retailers in **ALL STATES**. If you have a problem getting supplies or require the HERCULES Reloaders Guide, contact:

**FULLER FIREARMS GROUP  
PTY LTD**

**PO BOX 77, BEACONSFIELD NSW 2014  
Telephone (02) 662 2333**

\*Send \$2 for 32 page full colour comprehensive gun guide. Includes postage and handling.

# Scorpio

## Olympic Targets

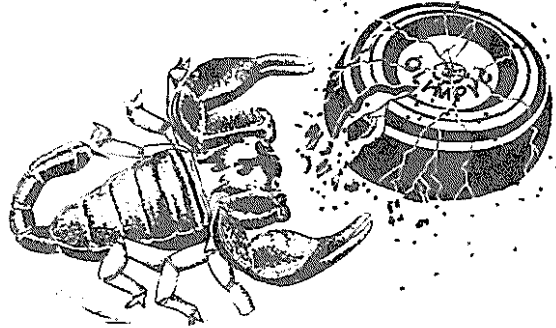

12 ROSEBERY ST., BALGOWLAH

Phone BH (02) 94 6607, AH (02) 948 8182, FAX  
949 4228

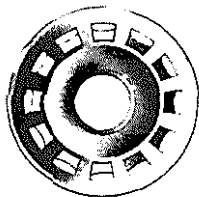
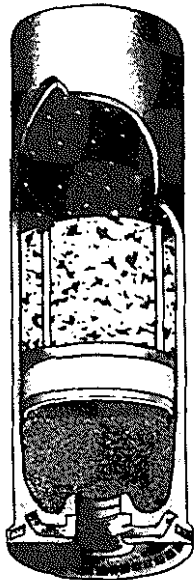

### SCORPIO CARTRIDGES WITH ACTIV SHELLS

1. Heavy gauge steel encased in the plastic head to ensure ACTIV shells are rust-free.
2. High quality all-weather ERT primer for accelerated reliable ignition.
3. Highest quality ERT powder.
4. Heavy gauge steel reinforced head, rim and primer pocket for better reloading.
5. Scientifically designed CORK wad. Engineered specifically for use in the ACTIV hull. Cuts recoil and protects shot.
6. The finest shot available to suit varied shooting needs.

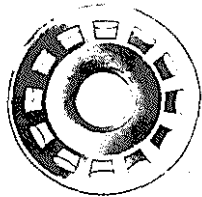
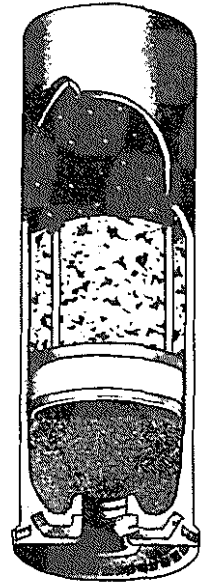

**12 GAUGE AND 20 GAUGE NOW MADE BY  
SCORPIO HERE IN AUSTRALIA. ALL SHOT SIZES.  
TRAP LOAD 32 GRAMS; FIELD LOAD 36 GRAMS.**

**SCORPIO CARTRIDGES make available the 75 low-recoil 2¾ DRAM EQUIVALENT.**

**The 100 low pressure 3 DRAM.**

**The 200 3¼ DRAM.**

**150 OLYMPIAN available in NICKEL-PLATED SHOT.**

**THE ONLY AUSTRALIAN MADE NICKEL LOAD.**

**LOADED WITH ERT POWDER. THE FINEST ALL ROUND TARGET PERFORMANCE.**

# CLAY TARGET

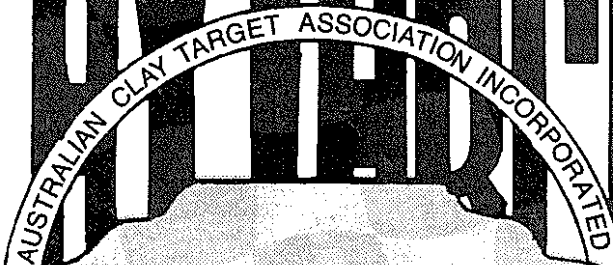

## SHOOTING NEWS

All Correspondence should be addressed to:

**Alan J. Maher**  
Executive Director  
P.O. Box 800,  
Glen Waverley, Vic. 3150  
Phone (03) 807 7577  
Fax (03) 807 2716  
Business Address:  
3 Essex Rd,  
Mount Waverley,  
3149.

CTSN is the official Journal of the Australian Clay Target Association Incorporated and is published monthly at Newsprinters Pty. Ltd., 159-165 High Street, Shepparton 3630. Phone (058) 20 1555.

The views expressed in this magazine are not necessarily those of the publisher.

Subscription rate is \$15 per annum.

National Coaching Director

**Peter Quire**  
13 Barr Smith Avenue,  
Myrtle Bank, S.A. 5064  
Phone (08) 79 8612

**Copy Deadlines:**  
September issue closes July 29  
October issue closes August 31

Typeset by BP TYPESETTING PTY. LTD.,  
7 Hampshire Road, Glen Waverley 3150  
Phone (03) 561 2111

**OFFICIAL JOURNAL  
OF THE AUSTRALIAN  
CLAY TARGET  
ASSOCIATION**

**NATIONAL EXECUTIVE**

**CONTENTS**

**Patron:** Sir Henry Bolte, G.C.M.G.

**President:** Mr J.K. Scott  
Yuulong, Dubbo, NSW 2830  
Phone (068) 82 5757

**Vice President:** Mr L. Martin  
15 Rita Ave, Rostravor, SA 5073  
Phone (08) 337 6453

**Committee:**

**Mr T. Catling**  
P.O. Box 117,  
Katanning, W.A. 6317  
Phone (098) 22 7033

**Mr J. McVitty**  
20 Dundas St,  
St Arnaud, Vic. 3478  
Phone (054) 95 2259

**Mr S. Browning**  
49 Sugarloaf Road,  
Riedonvale,  
Tas. 7016  
Phone (002) 43 6513

**Mr R. Brook**  
P.O. Box 121,  
Goondiwindi, Qld 4390  
Phone (076) 75 4121

**Mr N. Hardy**  
12 Patrick Street, Aitkenvale,  
Townsville, Qld. 4814  
Phone (077) 79 0638

**Mr J. Matthey**  
12 Orama Ave,  
Wendouree, Vic. 3355  
Phone (053) 39 2894

**Mr A. Burgess**  
18 Harcourt St,  
Gobar, NSW, 2835  
Phone (068) 36 2345

**Mr B. Growden**  
P.O. Box 24,  
Mundulla, S.A. 5270  
Phone (087) 58 8264

**Mr R.J. Smith**  
3 Cleveland Place,  
Sonnet Bay, NSW 2226  
Phone (02) 528 3878

**Mr R. Fox**  
35 Wellington Pde,  
Alawa, NT. 0810  
Phone (089) 89 4475

**Dr. P. Weis**  
P.O. Box 41121,  
Casuarina, NT. 5792  
Phone (089) 27 3990

**Mr R. Silvester**  
P.O. Box 91,  
Boyanup, W.A. 6237  
Phone (097) 31 5236 (A.H.)

**Mr J. Murphy**  
PO Box 82  
Kings Meadows,  
Tas 7249  
Phone (003) 44 7916

**Hon. Life Registrations:**

C. Mott  
J.M. Wilson (P.P.)  
E.F. Hawkins (P.P.)  
J.M. Tyquin (P.P.)  
G.H. Hall (P.P.)  
E.G. Biggs  
R.M. Holtfreter (P.P.)

R.H. Moysie  
A. Pedersen (P.P.)  
D.R. Taylor  
R. Mules  
N. Wells  
A.N. Rowe  
L.G. Connors (P.P.)  
N. Hardy

Executive Director's Notes.....	3
Obituary Mr John Houston.....	George Biggs 6
Handicap Cards & Score Recording.....	7
Unregistered Shooters.....	7
Wagga Gun Club.....	Maree Rooke 7
Sturt Pea from S.A.....	IMG 8
State ISU Skeet.....	9
Waratah State Notes.....	NSWCTA 10
Letter to the Editor.....	Orion C. Shockley 10
The Winchester 275.....	Ron Forsyth 12
Normanton Gun Club.....	Wayne Reeves 13
WACTA Report.....	John Fissioli 14
Maryborough Tit Bits.....	Lost Bird 15
Riverina Zone Carnival.....	15
Singapore Airlines Perpetual Trophy.....	15
Club News, Contents & Results.....	17
Vale.....	17
Eastern Goldfields Gun Club.....	19

**Front Cover: Dick Ayres of Winchester with his band of merry men to shoot for the title of "Winchester Junior Shooter" at the DTL Carnival.**

# EXECUTIVE DIRECTOR'S NOTES

Planning is well under way for the 1988 National Skeet Championships which will be held at Melbourne Gun Club from November 17-November 20.

This time of the year generally produces fine weather. This, when coupled with the often heard comment that "Melbourne is the home of skeet shooting in Australia" augurs well for a successful and enjoyable competition for those who decide to shoot the Four Day Nationals Program.

One of the National titles, the Skeet Doubles Championship, will have a new trophy for perpetual competition. The actual trophy which was won in competition by the Inaugural Doubles Champion, Paul Johnson of Victoria, is very complementary to the trophies to be shot for and is a very welcome addition to the A.C.T.A. trophy cabinet. Paul is to be commended for his thoughtful gesture and will no doubt be endeavouring to have his name inscribed as the 1988 winner — thanks Paul for your contribution to this National Title Event.

Other happenings of recent times include the meeting of the various Committees of the Association and the all important election of office bearers to see us through another year.

With retiring President, Roy Holtfreter, having previously announced his intention not to seek re-appointment, Jim Scott from the Orana Gun Club in Dubbo, New South Wales, was unanimously elected to the position of National President of the Association.

Jim has been an active shooter and worker for the sport at both State and National level for many years and his commitment to the Presidency will quickly be noticed.

Following a ballot for the Vice Presidency, Leighton Martin from International Gun Club in South Australia was elected as Jim's Vice President and we wish them both well in the demanding positions they have been elected to.

Again a ballot took place for the two remaining positions on the Management Committee and elected to Management were Tim Catling from Katanning in Western Australia and Townsville Gun Club member, Neil Hardy.

Both Neil and Tim have a wealth of experience in the sport and will serve the Association well during their term of office.

With no less than five members attending their first committee meeting, one could have expected that the input to the meeting would not have been as great as on previous occasions. It is pleasing, therefore, to report that all new members settled in very quickly and without exception played a contributing role to the success of the meeting.

Those welcomed for their first meeting were John McVitty (Vic), Richard Brook (Qld), Jim Bitossi and Bob Fox (N.T.) and Ross Silvester (W.A.). Rejoining the Executive following the resignation of Victoria's two members L. Connors and R. McDonald was Jack Matthey from Beaufort.

All of these new members will be introduced to members in forthcoming issues of the C.T.S.N. and we wish them all well as they contribute to the development of the sport.

On a sadder note was the news that long serving Executive Member and Past President, Laurie Connors, was resigning from all positions at State and National level. Those who have come to know Laurie over the years will realise that his departure along with that of Roy Holtfreter leaves a gap in experience that will be difficult to fill.

For my part, Laurie was very supportive at my introduction to the sport as Executive Director. I shudder to think what those early months would have been like without his support and guidance and I thank him for the

part that he played in enabling me to come to grips with a sport that I was totally unfamiliar with.

Thanks Laurie, we all hope that you will still be seen "around the traps" to use your own words and look forward to receiving news from you for the C.T.S.N. if you are able to find the time.

Nationals dates for the next few years were decided upon and they are:

**TRAP:** 1989: Victoria, at Echuca; 1990: Tasmania, at Evandale via Launceston; 1991: South Australia at the Virginia Park Complex; 1992: New South Wales; 1993: Western Australia at the Whitman Park Complex.

**SKEET:** 1989: New South Wales — Wagga Wagga (to be confirmed); 1990: Victoria — Melbourne (to be confirmed); 1991: Queensland — Townsville.

**I.S.U.:** 1989: Victoria; 1990: Western Australia.

The A.C.T.A. Presidential Medal was the subject of review and the decision was taken to increase the number of medals which may be presented in any one year from one to three.

A recommendation to form a National Rules Committee was discussed at great length and subsequently approved. This Committee which is comprised of three members from the National Executive Committee, namely John Murphy (Tas), Robert Smith (NSW) and Tim Catling (WA) will assume the responsibility on recommendations that may be made to introduce or make alterations to the Shooting Rules.

This responsibility was previously in the hands of the Referees Association who were mainly responsible for the recent revamping of the Rules, a long and tedious exercise for which they have been congratulated.

The procedure that will now apply is that the Referees Association will operate as a consultative body to the Rules Committee and will advise of their thoughts on all matters pertaining to the Rules prior to recommendations being presented to the Executive — we believe the new system will work well for the sport.

Another Committee to be restructured was the National Shooting Committee which previously comprised two Executive members, National Coaching Director, Peter Quire, and three shooters representatives drawn from the total membership.

This Committee will now comprise two members from the National Executive, National Coaching Director, and three shooters representatives, each representing a distinct discipline and not elected from members of the National Executive.

Elected to the National Shooting Committee were Robert Smith (NSW Executive) Chairman, Tim Catling (W.A. Executive), David Menck (N.S.W. I.S.U.), Bob Dower (S.A. Skeet) and Peter Hayman (N.S.W. Trap), plus the appointment of Peter Quire in his capacity as National Coaching Director.

Should you, as a shooter, wish to have any matter raised at meetings of this Committee then these are the men to speak with. Please bear in mind that while as shooters representatives they will be acting on behalf of all members, David, Bob and Peter have been elected to represent a particular discipline which is in their field of expertise.

Correspondence that may be forthcoming will be forwarded to the members of this Committee through the National Office.

Another decision of great importance was the establishment of a property debenture program.

This program has been set in operation to ensure the long term stability of the Association with the eventual purchase of a property suitable to the needs of the sport.

Details of the debenture program are published separately in the C.T.S.N. and the early support that has been advised is more than just encouraging, it is an indication that the decision is a correct one and one that will serve members well for many years to come.

Please give it your fullest consideration and for those

Cont'd over page

Cont'd from previous page

who wish to become a part of the program, advice of your intentions will be welcomed.

Registration fees for 1989 were discussed at great length with the decision taken to accept the recommendation from the Management Committee to restrict any rise to a figure in keeping with the National C.P.I.

As from 1st December when registrations will be accepted for 1989, registrations will be Full Member \$37.00, a rise of \$2.00 or 5.7%, Second Family Members and Veterans over the age of 65, or 60 with 30 years of continuous service, \$21.00 which is an increase of \$1.00 or 5%, with no increase in Junior Registrations, remaining at \$10.00.

One of the major decisions taken was the one to introduce an Accident Insurance Policy covering all members. This insurance is in addition to our obligatory Public Liability Insurance and should be welcomed by all shooters.

Obviously there is a cost involved and in this case the cost is \$3.50 per member which will be met by debiting each and every club on a per member basis.

The policy is planned for introduction as from 1st August and will provide benefits within the policy conditions of \$40,000 in the event of a death occurring and \$400 per week whilst injured and not receiving weekly income.

Full details by way of a summary of the policy conditions will be published in the C.T.S.N. as soon as the policy has been finalised.

The decision to introduce this form of member protection was not one lightly made, clubs had been advised of the investigation that was taking place and requested to voice their opinions at the last Annual General Meeting.

With an almost 100% acceptance by member clubs at that time to introduce this form of insurance the matter of payment was the only contentious issue.

The per capita club membership was most favoured by the Annual Meeting and this is the method that has been adopted following the recommendation made at the Annual Meeting by member clubs to the National Executive Committee.

Club membership at 30th June will be the basis of club payment, this will be reconciled annually at 31st December with any new members registered after 30th June being debited to the club account.

The Executive believe that the introduction of an Accident Insurance Policy is in the best interest of all members. This view is shared by the fact that clubs have given an almost unanimous acceptance to the proposal since the idea was first promoted.

We certainly do not wish for a claim on the policy to be the contributing factor in receiving total unanimous acceptance — the lack of claims against the policy is what we are aiming for as this will ensure an accident free period for all clubs and leave shooters free and able to enjoy their chosen sport.

Another new innovation is the introduction of a facsimile machine, again a recommendation to the Executive from member clubs at the Annual Meeting.

The Fax Number is (03) 807 2716 and for those with access to a personal fax, the opportunity to use a commercial fax or even the Australia Post Public Fax facility, the ease of ensuring that your information is received at the National Office without undue delay will be a decided asset.

As far as the receipt of notices and the like for the CTSN is concerned, the fax will now allow a little more time for clubs to prepare their notices and still guarantee they have been despatched for delivery by the copy deadlines.

Please make use of this fax facility which has been installed at your request for your convenience.

I am pleased to be able to advise that Queensland

Executive Member, Neil Hardy, has been granted an Honorary Life Registration for his service to the sport and his service over the last 10 years as a member of the National Executive Committee.

Neil, a dentist by profession, has given freely of his time over his years at National Level and continues to do so. This is seen in 1988 by his election to the four member Management Committee where his judgement and experience will hold him in good stead as he continues his involvement on behalf of all shooters.

Congratulations Neil for the honour you have had bestowed on you and we trust that your Honorary Life Registration is enjoyed for many years.

Membership has continued to increase, due no doubt to the situation that existed in N.S.W. and to a continuing degree in Victoria and other states.

At the time of writing membership has passed the 10,000 mark and we certainly hope that the new members that we have received participate in the sport at all levels and remain with the Association for as long as they continue to be known as shooters.

If you see new faces around your club or wherever you may be, please make them welcome and share with them one of your greatest treasures, friendship.

A new member can be lost quite easily by not being made welcome and while we all believe that we make new shooters welcome at all times, experience tells us that this isn't always the case.

By helping a new shooter to enjoy his or her sport you will also reap the pleasure of their success, why not try it at your next opportunity?

Your attention is also drawn to one of the conditions of entry for all State and National title competitions. This condition has been the subject of review and change many times. At last it is felt that the correct mix has been achieved. Please be aware of the decision that has been made which in effect is:

The overall trophy can only be won by the payment of a full nomination. By winning the overall, a shooter shall then be declared ineligible for grade and or section trophies (Lady, Junior, Veteran).

For other than overall, shooters shall be eligible for grade and section trophies for all events providing a full nomination has been paid.

Shooters electing to pay a reduced nomination shall only be eligible for the section of the event entered.

In closing I must make mention of the recently formed Australian Skeet Shooters Association. The A.C.T.A. did receive a request from the solicitors representing the Skeet Shooters Association for permission to register the name "Australian Skeet Shooters Association".

This request was made following receipt of correspondence from the Corporate Affairs Department which pointed out the similarity in the name and objects of the Skeet Association to the Australian Clay Target Association.

As the matter had been formally brought to the attention of the A.C.T.A. it was the decision of the Executive that permission for use of the name requested could not be agreed to. This decision was made in the best interest of all members owing to the correspondence received from the Corporate Affairs Department in Victoria and for no other reason.

This information has been advised to the parties concerned who will now need to become incorporated under a different title than was contemplated.

A lengthy report of the involvement of members elected to represent you at National Level — their attention to the matter at hand is a reminder to all of their commitment to the sport.

Good shooting in the months ahead.

Alan Maher,  
Executive Director.

# 1988 SKEET NATIONALS MELBOURNE GUN CLUB

NOVEMBER 17-20, 1988

**Thursday**

**EVENT 1** — 2nd National Skeet Doubles C'ship — 50 Target

**EVENT 2** — City of Melbourne Skeet C'ship — 50 Target

**Friday**

**EVENT 3** — All States Skeet C'ship — 50 Target

**EVENT 4** — Australasian Skeet C'ship — 50 Target

**Saturday**

**EVENT 5** — Commonwealth Skeet C'ship — 100 Target

**Sunday**

**EVENT 6** — 19th National Skeet C'ship — 100 Target

**Nominations: 50 Target Open — \$20; 50 Target Section L.J.V. — \$12; 100 Target Open — \$35; 100 Target Section L.J.V. — \$21.**

**OVERALL HIGH GUN — Browning 105-B2C Shotgun donated by Fuller Firearms Group Pty Ltd.**

**Tournament Director  
R.F. Buchan**

**Shoot Marshal  
A. Cousens**

## RULE BOOK CHANGES

Please note the following amendments to the Rules as published in the Official Rule Book, printed effective April 1st, 1988

**Guidelines for Referees: Page 4 Number 9**

- (1) Delete the wording "or any time competitors or other personnel are in front of him".

**Trap Shooting Rules: Page 28, 2.3(f)**

- (2) The first sentence has been amended to read: "In a group handicap event shot from handicap marks, the winner of each group will be handicapped one metre providing they have shot the possible".

# DEBENTURE PROGRAM

AN INVITATION TO MEMBERS ONLY

A legal document is being prepared to allow for the implementation of a Property Debenture Program to allow the Association to purchase a building to establish a permanent home for the administration of the sport and to cater for the needs of its members.

The following clauses along with any other legal requirements will be included in the Debenture Document:

- A. Debentures to be of a minimum of \$1,000 or multiples thereof.
- B. In the event of a debenture holder's death occurring, the debenture to be immediately available to the deceased estate.
- C. In the event of a syndicated debenture holder's death occurring, the payment of any syndicated share will be the responsibility of the remaining syndicate members.
- D. Debentures to be for a maximum period of ten (10) years.
- E. Debentures to be repaid within a ten (10) year period (maximum) in accordance with annual results achieved by the Association.
- F. A maximum of 150 debentures be available at \$1,000 each or alternatively a total debenture issue of \$150,000.
- G. Interest to be paid annually at a fixed interest rate of 7.5% with 1st December being the effective date.
- H. Secured by floating charge.
- I. Assets constituting security, A.C.T.A. Building Fund Investments.
- J. Floating security to become a fixed security on the purchase of property for the purposes specified in the debenture invitation to members.

Applications from registered shooters, clubs, Zone and State Associations are now being received and will continue to be received up to and including 30th November.

For any further information on the issue of Property Debentures, please contact either your State's Representatives to the National Executive Committee or the Executive Director on (03) 807 7577, or complete the Debenture Application.

**The Executive Director,  
P.O. Box 800,  
GLEN WAVERLEY, VIC. 3150.**

## PROPERTY DEBENTURE PROGRAM

I wish to be placed on the list of Debenture Holders for a debenture amount of:

\$ .....

I understand that I will be contacted to exercise my debenture once all legal requirements have been attended to.

Please record my application under the following:

NAME: .....

ADDRESS: .....

.....

STATE: ..... POSTCODE: .....

I can be contacted on the following telephone numbers:

P..... B.....

SIGNED: .....

# OBITUARY MR JOHN HOUSTON

FROM GEORGE BIGGS

One of the best known personalities of the Hay district, Mr John Houston, of "Budgewah" and "Tongul" passed away on Wednesday, June 1 at the age of 87 years.

John Houston will be remembered by the many hundreds of clay target shooters that visited the Hay Gun Club over the years especially the very popular Annual Easter Shoot.

Shooters came from all over to shoot in the Easter Carnival, the grand prize for the main event being a motor car. The social event of the program was the dance on Saturday night and a wonderful barbecue on Sunday at "Tongul" on the banks of the Murrumbidgee River. John was the most gracious host.

One occasion I will never forget was shooting in the Car Shoot one easter. The conditions were 30 birds double barrel from handicap marks. My handicap was 27 yards and I missed my 30th target. Was my face red! I couldn't find a hole big enough to fall into. Over the years my family and I spend many enjoyable hours with John and his family.

John Houston was President of the Australian Clay Target Association from 1957-1961. His interest in clay target was keenly Australia wide. He was a much respected and popular person. He was a member of the Mackintosh International Team on several occasions and a honorary life registration member.

Photo shows John third from left, back row, with a group of Hay Gun Club members when they attended the National Championships in Melbourne, 1954.

John Houston was a foundation member of the Hay Historical Society and a long time President.

Many members of the A.C.T.A. will recall that he collected antique pistols and firearms for many years. It was his intention, since realised, for the collection to be housed and displayed in the Hay Museum, established in the old Hay Gaol.

Mr Houston was a member of the Committee of Management and an Elder of the Hay Presbyterian Church for many years, and also on the Council of the Hay Students Hostel, Cloughton House. He was a long serving President of the Hay Branch of the Far West.

His great love in sport was hunting, shooting and fishing in the bush. He re-established the old clay target shooting, Hay Gun Club, and presided for many years as it became one of the leading clubs in Australia. For three years he was the Australian President of the Australian Clay Target Shooting Association.

Mr Houston's civic activities earned him the distinction of being awarded the first citizen of the year award by the Hay Apex Club.

In a personal tribute, during the service at St Andrew's Presbyterian Church, Brough Gibson recalled some of the happy memories of picnics in the hopbush near

"Kangaroo", a tune on the mouth organ, a sing-song around the piano, his cooking breakfast for visitors and barbecues on the river, of finding a duck, quail, pig, yabby or kangaroo tail in the coolroom on Tongul.

He mentioned local graziers' interest in his legends about "grey birds" as a sign of rain, and "green pick on the sandhills at Lamorna by Queen Victoria's birthday, 24th May, as an omen for a good or bad winter".

Mr Gibson concluded by saying that "Jack" was one of the most unforgettable characters he had ever met, an opinion shared by many.

Mr Houston is survived by his wife, Dorothy, son David and grandchildren Lani and Rowan and sisters Miss Marjorie and Noreen (Mrs N.R. Smith) all of Hay.

Brothers, Hillis and James (Max) predeceased him.

The service at the church and graveside was conducted by Rev Jonathon Boyall.

Children of Cloughton House and Hay Gun Club members formed a guard of honor.



**WINCHESTER 9422 XTR CLASSIC RIFLE**

- Satin finished walnut stock with fluted comb & crescent steel butt plate
- Curved finger lever & undercut pistol grip with cap
- Extended forearm with barrel band
- Long 22½" barrel for long range accuracy
- Available 22 Long Rifle & 22 Magnum.

**WINCHESTER** 



## HANDICAP CARDS AND SCORE RECORDING

Rule 2.1(J) "No shooter, other than those awaiting the issue of a card after registering for the first time, shall be allowed to enter in any competition unless he submits his card to the designated club official on each shooting day. However, if a shooter has lost his card he shall be allowed to compete providing he is registered with the A.C.T.A."

This rule on producing a handicap card when competing is self-explanatory and further explained in 2.1(K)(L)(M).

Rule 2.1(H) "It shall be the responsibility of a designated club official to progressively mark the shooter's card with his 15 metre results and after each 200 targets, regrade the shooter if necessary."

Complaints are being received that in many instances these rules are not being complied with.

In the best interests of the sport, please ensure that you continue to comply with the shooting rules and if you happen to be an offender, please remember the rules are made for one and all and not all and one.

## UNREGISTERED SHOOTERS — RULE 4.16D

Club administrators and all registered shooters are requested to ensure that they comply with Rule 4.16D of the current rule book which reads:

"All competitors must be registered by the A.C.T.A. before taking part in competition. Unregistered shooters are not permitted to compete at any time."

Should this rule not be complied with any matter that may arise concerning insurance would be jeopardized owing to the non-compliance with the rules.

While this is one factor that must be addressed, the other important one is that registered shooters provide the backbone of the sport and unregistered shooters should not be able to take advantage of facilities etc. that they have not and are not contributing to.

If you know that you are shooting in a squad with an unregistered shooter who does not fit the categories covered by insurance, then he/she is placing you at considerable risk despite the fact that you are complying with the rules — it's worth thinking about isn't it?

## WAGGA GUN CLUB — NATIONAL TRAPPERS HAVE A SHOT!

The Wagga Gun Club extended an invitation to all the trappers who trapped at the Nationals in April for an afternoon of shooting.

The hard working trappers quite often go without a mention or thanks, so the Wagga Club provided the clays and Winchester the shells all free of charge.

The trapping was done by the Koorngal Rotary with assistance from the Wagga Army and RAAF Bases. It was a superb job done, with many working very long hours.

Most of us prefer to shoot at the targets rather than put them on the traps!

The afternoon was enjoyed by all the Army and RAAF boys. They may not have shot the top scores but they sure knew how to put the afternoon tea away!

A big thanks to those club members and accredited coaches who gave up their afternoon to assist, and to Winchester for the case of shells.

Maree Rooke  
Publicity Officer.

MANUFACTURED TO  
AMERICAN SPECIFICATIONS

SAVE UP TO  
30%  
ON PRIMERS

Martignoni's modern production methods raise the quality and lower the price to Shooters. Why pay more? Martignoni makes over 1,000,000 primers per day to supply many of Europe's leading cartridge makers. Shotshells with Martignoni primers have won many major European championships.

Ask for the best price  
... on MARTIGNONI

Australian Agents:  
Fuller Firearms Group Pty. Ltd.,  
P.O. Box 77, BEACONSFIELD,  
NSW 2014  
Telephone: (02) 662 2333

★ Send \$2 for 32-page full colour comprehensive gun guide.  
Includes postage & handling.

MARTIGNONI

# STURT PEA FROM S.A.

## STATE SKEET CARNIVAL

This carnival was held on 28th and 29th May at S.A.G.C. in cool weather with an attendance of 63 over the two days, this being one less than in 1987. Nevertheless it was a very good carnival and we got through the events in good time, especially on Sunday. This was due to the excellent support from those running the shoot and keeping it going.

As you will see in the shoot report in this issue of C.T.S.N., the trophies were shared around a bit.

Kym Holmes from Mt Gambier came out on top over the carnival by the small margin of one point 185/191 after a shoot off for O/A winner. Well done Kym, but I don't think he dared to miss as his wife, Janet, had her eye on the O/A trophy which was a very lovely necklace and earring set.

Second in O/A was a visitor from Melbourne, David Cunningham, who shot 184/191 after shooting off with Kym. David shot extremely well over the weekend being placed either 1st or 2nd in AA in all events.

Brigitte Dower scooped the pool in the Ladies, winning the O/A of the Carnival. She was Ladies winner in all events except the 25T Skeet Doubles, when Sandy Appenkamp showed all that she liked this event and won the Ladies trophy 22/29. Congratulations and well done, Sandy.

Peter Caddy kept a point or two in front most of the time to eventually be the Veterans O/A winner 150/175.

There were no Juniors competing in this section.

Central Zone was the winning Zone team, 124/125, comprising R. Dower, D. Sparnon, B. Murphy, R. Kimber, T. Keane.

The top five scores of the Postal Team was D. Sparnon, R. Dower, R. Kimber, D. Burton, K. Holmes. This will be the State National Team if all are intending to represent their State by going.

All teams will be given a certain time to let me know their decision as to their intentions in competing at the National Titles. I will, in due course, do this by letter. The next Team Member in line will automatically be contacted if any of the five do not reply by the given time.

Photos of the Carnival will be available for the next issue.

## OLYMPIC TRAP

Held on the same weekend as the Skeet and attracting 41 shooters. Due to lack of time, the 100T on Sunday was reduced to 75T, otherwise the O/Trap was deemed to be very successful.

The O/A winner was C. Bentley 172/200; AA G. Mark 162/200; A F. Vella 167/200; B P. Green 167/200; C P. Hall 133/175.

The Postal Team High Gun winner was Phil Green 24/25. Having to work in the office as well as shoot didn't seem to upset his shooting ability.

Thank you to Mary Martini for doing the book work for the O/Trap.

I would now like to take this opportunity to thank S.A.G.C. for the use of their grounds which were in their usual excellent condition. To all the workers in the office and outside on the tracks, not forgetting the trapper boys, an excellent job done by all. We must also remember the ladies in the kitchen who feed the never-ending multitude of people all weekend.

Now, last but not least, thank you to the sponsors. MULWEX were again very generous and we thank them for their support by giving us four tins of powder of 2.5kg each, worth some \$80 each.

The company would be pleased to get some feedback on their product, so those winning a tin might be good enough to let me know so that I may be able to pass the message on.

THE GUN RACK — Les Charles also again gave

S.A.C.T.A. a donation towards the Skeet Carnival as he has done over the last few years.

## EXECUTIVE MEMBERS

Brian and Leighton were unable to attend the carnival due to it clashing with a National Executive Meeting in Melbourne that could not be changed.

Now after all that, Brian did manage to get a very early flight back to Adelaide to be able to attend on the Sunday. After borrowing everything to shoot O/Trap he managed to come first in AA on the 75T Sunday.

On behalf of the members in S.A. I would like to congratulate Leighton on being elected to the position of National Vice President.

## PROGRAMME CARDS

Hopefully, all cards have been returned to me, as the deadline was July 30th. Please be very quick if yours are not back, as I will very shortly be taking everything to the printer.

## COMPLEX

By the time you read these notes, development will have started on Stage One of the S.A.C.T.A. Clay Target Range at Virginia with International Gun Club being the resident Club. The building of the Range, as I have mentioned before, is under the guidance of Metro Martini.

## I.S.U. ELIMINATION

Moves have been put into motion for Zone Eliminations of 100 Targets I.S.U. to be shot over O/Trap and B/Trap at Mt Gambier and Pt Augusta and S.A.G.C. The top eight shooters from each Zone elimination will shoot a 100 target final at International or S.A.G.C. late in October to select a 5 man Training Squad and then a Shoulder to Shoulder Team to compete at the Nationals.

The elimination targets have been reduced to 100 for 1988 only due to lack of time. At the next Council meeting, a proper programme will be organised to be put into action for the 1989 year and these elimination dates and places will be programmed through the Programme Book.

## MAJOR TITLES FOR AUGUST

First of all I do believe an apology is in order to the Victorian shooter who travelled to Mt Gambier for the S/B Commonwealth Title on June 11. This had been changed to October 8th. It is advertised in Mt Gambier programme for that date, but was not changed at the front of the P/Book. So can you please take note of this error.

August Sat. 6 and Sun. 7 — S.A.G.C. I.S.U. 100 Targets Skeet; 100 Targets O/Trap.

August Sun. 14 — Wilkawatt State Night D/D.

Don't forget the winners of the above State Day and



The Aussie pastie that you can nearly see under the sauce, was good tucker for Don Beellitz at the D.T.L. Carnival.

Night Titles are eligible to shoot off for the Ray and Pat Mack Trophy at the D.T.L. Carnival. This is to be a perpetual trophy.

### RULE BOOKS

Available through me at a cost of \$3.50 plus postage.

### WESTERN ZONE CARNIVAL

Held on the 14th & 15th May at the Pt Lincoln Gun Club in cold and drizzly conditions with an attendance of 36 shooters. The Fisher Firearms Teams Shield was contested over the first 25 Targets on Event One, the W.Z. Skeet Championships of 50 Targets.

Pt Lincoln won the shield on a countback from last year's winners, Pt Augusta, by four points after both teams had a tied score of 119/125. The Zone Skeet Team was selected for the forthcoming State Titles, being C. Bentley, R. Bisi, L. Trebilcock, W. Fisher, A. Norman. The Zone Trap Team was also selected over this weekend's results, plus each club's D/B, C/S between now and the State D.T.L. Carnival.  
L. Trebilcock.

### BORDERTOWN GUN CLUB

Again hosted a fun day for the Mundalla Football Club on June 19. We have some promising shooters amongst the footy guys once they have retired from the game. There was a variety of events D/B, S/B, D/R, P/S and a D/D. The D/D was a Gun Club member with a footy member, causing a few laughs and much fun comment amongst everyone, won by Andrew Shuttleworth and Brian Growden. Everyone enjoyed a barbecue tea with wives and children. They then had a night D/B event to round off the day. Michael McGrice won the O/A out of the footy guys as he did last year. Soon to become a dad, his mates think he should stay home and baby-sit next year. Michael received a packet of cartridges and Andrew Shuttleworth, who is Michael's brother-in-law, got the booby prize — a nice white roll of toilet paper. The Gun Club looks forward to another day next year.

I.M.G.

## ATTENTION: S.A. I.S.U. SHOOTERS

**100 TARGET ELIMINATION ZONE  
SHOOT WILL BE HELD AT:**

**S.A.G.C. on August 7**

**Pt. Augusta on September 17**

**Mt. Gambier on October 10**

To select the top eight shooters from each Zone to shoot for team selection and S.A. State Training Squad.

A 100 Target final will be held at International G.C.  
Contact your Club Secretary for further details

**Brian Growden: President**

## STEVENS & SONS FIREARMS

785 Old Cleveland Rd, Carina, Brisbane  
4152. Qld.

### BROWNING CLEARANCE SALE

#### NEW

A-1 Broad Ribs	\$3950.00
A-1 10mm Ribs	\$3950.00
A-3 10mm Ribs	\$4200.00
B-1 10mm Ribs Cased	\$4800.00
B-1M 10mm Ribs Cased	\$4950.00
B2C 10mm Ribs Cased	\$5750.00
Sariugarte FS 400	\$2450.00

#### AS NEW . . . SECONDHAND

B2G Sporter	\$4200.00
-------------	-----------

Phone (07) 398 3118 — (07) 398 1833

## STATE I.S.U. SKEET

Pleasant conditions greeted 27 shooters for the State I.S.U. Skeet titles at the C.M.T. Clay Target Club on the 18th and 19th June.

Club President, John Harris, welcomed all to the club, wishing the good shooting for the weekend. Although numbers were not high, John remarked on the quality of the shooters. The concentration and dedication to shoot this discipline is of the highest order. Edd Powell, Captain, wished shooters well, and asked all for promptness and gun safety.

Scores for the first day saw some excellent rounds. Leaders were: D. Kevill 92; J. Coci 91; J. Harris 90; A. Forsberg 90; J. Carboni 87.

Sunday saw overcast skies and strong wind. Scores declined with the conditions, with some shooters having trouble holding their balance on the pads.

After the 150, the State Team members were: J. Harris 134; D. Kevill 133; A. Forsberg 133; J. Carboni 131; J. Coci 129.

The final two rounds being shot in difficult conditions, the pressure was right on. John Carboni shooting the possible in the last round to edge out David Kevill for the silver.

Overall placings were: A. Forsberg — Gold; J. Carboni — Silver; D. Kevill — Bronze.

Overall grade winners: A Grade — J. Coci; B Grade — J. Harris; C Grade — K. Baker.

President, John Harris, presented medals and trophies to the winners. John also thanked the ladies for their work over the weekend. A barbecue followed the presentation with everybody seeming to enjoy themselves.

# WARATAH STATE NOTES

By the time that you are reading this month's report, our State Skeet Carnival is only a few days away. There are a couple of additions to the program that appeared in the July issue of C.T.S.N. — those being that a Perpetual Cup has also been allocated to event 2 — the N.S.W.C.T.A. Championship — this is in addition to the new Perpetual Cup on the State Championship — event 4. There will also be a veteran's trophy allocated on all five (5) championships.

## NOTES FROM THE LAST EXECUTIVE MEETING:

The State Executive Committee met on 25th June and the following matters are for our information:

- 1: All clubs in N.S.W. will be issued with a copy of the new Rules book — with the State Association's compliments;
- 2: All Clubs hosting any State Championships — commencing 1989 — will receive the overall sash and championship badge — with the State Association's compliments;
- 3: A complete re-organisation of Referee Examiners has been carried out — with new ones being appointed in some areas. All referees will be contacted in the near future — to arrange for re-examination to take place;
- 4: All Clubs be encouraged to have at least one registered referee — further details have been forwarded to all Clubs in the State;
- 5: State Carnivals have been allocated for 1989 as follows: I.S.U. — Illawarra; Skeet — Wagga; Trap — Moree;
- 6: Membership registration to the A.C.T.A. will rise by \$2.00 for 1989 per full member; \$1.00 per second family member and veteran members with no increase in junior registration fees;
- 7: That any club guilty of breaking ANY rules will not receive any championship allocation for the following year.

## FROM THE CENTRAL ZONE:

The Zone Trap Carnival is set down for the 30th/31st July — just about now — at the Grenfell Gun Club. From all reports the Club Committee have really worked very hard to bring everything up to scratch for this carnival. It's great to see the smaller clubs having a go at these bigger shoots.

Also in the Central — a new Club has been approved — Kenworth, which is at Bedgerabong — only on a small scale at this stage, however could develop in the future.

## FROM THE NORTHERN ZONE:

Our roaming Skeet reporter, Kevin Weatherall, supplied some interesting bits from the Zone Skeet Carnival which was held at the Coffs Harbour Club in June.

Coffs Harbour Club can be proud — they did it well. From a blustery and wet week, right up until Friday evening — then Saturday morning turned out tremendous. And that is the way it was all weekend — fine, warm and still — perfect conditions for good scores. However that was not the case for the average shooter on Saturday with scores being down. Sunday saw smiles as scores improved and "shoot-offs" went on.

A strong representation from southern Queensland — without their captain/coach Ray Porter, made their presence felt by cleaning up most of the events. Ray has been offered free accommodation and copious quantities of "Bundy" to accompany his team to the N.S.W. State Skeet Carnival in August at Tamworth.

Kevin finished by adding — weather perfect, food and hospitality tops, trophies first class, management excellent and there is no doubt that those who attended will return and those who missed it — don't miss it next year.

Some results were: Handicap won by Neal Dimmick; event 2 was taken out by Doug Siggs from Dave Dundon; the Zone Championship also by Doug Siggs with 86/86; and the last event — you guessed it — Doug Siggs again with 54/54. Doug also won the Overall High Gun trophy with a score of 197/200.

The Northern Zone Team comprises Ray Melville, Kevin Weatherall, Geoff Walters, Doug Jackes, Bill Clark and Cec Herbert.

Zone President, John Farrell reminds all clubs of the next Zone meeting which will be held at the Inverell Gun Club on Saturday, 20 August — to commence at 5.00pm or soon after the shooting has finished.

## FROM THE SOUTHERN ZONE:

The Majura Park Gun Club will be holding the Southern Zone Double Rise and Deauville Doubles Championship at their Club from 11.00am on Sunday 7th August. Further information can be obtained from P. Turner (062) 88 0077 A/H.

Plans are well under way for the staging of the Zone Trap Carnival and Team Elimination — this being held at the Illawarra Club on the 11th September.

## FROM THE WESTERN ZONE:

The Western Zone held their A.G.M. recently and all existing office bearers were re-elected — President: Peter Holmes; Secretary: Paul Tattam; Coach: Kevin Constable; Handicapper: W. Powell.

The West have also approved another Club — Roto which is near Hillston. More details on that one as they come to hand.

The Western Zone Trap team comprises: R. Jenkins, A.M. Burgess, P. Osbourne, R. Slacksmith, P. Holmes, B. Holcombe, G. Betts, K. Constable, D. Boyd, R. Fitzalan and J. Francis — reserves being J. Baldry, D. Osbourne, T. Hudson, W. O'Rourke, F. Higgins.

While still in the West — the Dubbo Gun Club have asked for permission to alter the date of their shoot in November from the 6th to the 12th — approval has been given — so would you all make the necessary alteration in your Blue Book — this also includes the STATE NIGHT DEAUVILLE DOUBLES CHAMPIONSHIP.

That's all for this month — good shooting — and don't forget to send in any information to help boost up this monthly report.

N.S.W.C.T.A.  
P.O. Box 836,  
TAMWORTH, 2340.  
(067) 65 2520

## LETTER TO THE EDITOR

Dear Mr Maher,

Just a few lines to let you know how things have gone for me since I was last in Australia, which was March of this year.

I certainly regretted missing the Nationals in Wagga Wagga. I suffered my second heart attack just a few days before leaving Gympie and wound up in the Prince Charles Hospital in Brisbane for three weeks. After stabilization I flew home and found that I had to have open heart surgery. This was done on May 24th and I am now recovering.

They say that I can go back to shooting by November. If so, I will again come to Australia in April for your Nationals. I have certainly enjoyed my association with the Australian shooters and hope I can continue to participate in the shoot. However, I am now seventy, so who knows how long one has left?

Thanks for your attention.

Very truly yours,  
Orion C. Shockley.

## WORLD MASTERS GAMES 1989

**JULY 22-AUGUST 6**

Information on all sports including shooting  
can be obtained by writing to:

**World Masters Games  
Vestergade Arhus C  
Denmark.**

**Telephone: + 456 20 9988  
Fax: + 456 20 9889**

**The Victorian Clay Target  
Association State Skeet Carnival  
which was scheduled to be run at  
Mildura Gun Club on September 9,  
10 & 11, 1988 will now be run at the  
Melbourne Gun Club on the same  
dates.**

## *R. E. Sharp & Sons Gunsmiths*

*Specialists in all aspects of repairs, alteration, customising and complete restoration of modern  
and antique firearms. Large range of spare parts.*

*Please note our new address:*

*15 Welton Drive,  
Coldstream, 3770  
Postal Address: Box 727,  
Lilydale, 3140*

*New Business Phone Number:*

*(03) 739 1068*

# PERAZZI

**The Guns with the latest and up to date technology built into them:**

Perazzi is the innovative gun that has done so much for so many in such a short time (in comparison with other manufacturers) since their introduction that it is obviously the quality gun of the present and very possible the gun of the foreseeable future. It is the gun that amazes shooters (beginners and experienced) with its most effortless speed and ease of handling to give you the scores. That score that makes you a winner — in fact if you take notice it is the gun that is making headlines up front more often most times for the percentage of guns used.

Now analyse this and you must surely convince yourself that value for money your first or next gun must surely be a PERAZZI. Their balance is superb. We have so many of the more popular models in stock that there must surely be a model to suit you. If not, it would only be a telex call away and remember they are easy to shoot and extremely soft on your shoulder.

Also you must surely appreciate the simplicity of its dismantling and reassembling quality system as the innovation of the century and second to none in gun design. If you haven't seen one, ask anyone who has one. He would be as proud to show it to you as he is to own it.

So now think positive — "PERAZZI FROM YOZZI".

**Tony Yozzi Sports,  
460 William Street, Perth. 6000.  
West Australia.**

**Ph. (09) 328 4981 A.H. (09) 271 2766**

**SOLE DIRECT** factory representative and distributor for Western Australia for PERAZZI FIREARMS — AMMUNITION — **Special Shooting Glasses** supplied in **Miniature Case** resembling **Perazzi Gun Case** with **Optic Cleaner** included — **Saga** ammunition — **Kromson** clay target traps 240V — 12V and standard hand traps. All in stock now.

Also W. Australian importer of fine **BENELLI** auto and **F'GI GAMBIA** D.B. shotguns.

Latest illustrated coloured catalogues available.

Genuine trade enquiries welcome. All enquiries and orders immediately attended to irrespective of state.

# THE WINCHESTER 275

Ron Forsyth

I was pleasantly surprised to be advised by Winchester recently that the well known 275 has been resurrected in its familiar gold AA case, and is now back on the market.

The numerical designation of the 275, in case newer shooters are not up with it, indicates its power rating, and the cartridge has a 2¾ drams equivalent velocity. Most regular shooters will be aware of the rest of the graduated Winchester factory line up for target shooting — the 300, the 325, 350.

The 275 is by definition a load that gives a nominal 1145 fps to 1¼ ounces of shot, just as the 3 DE gives 1200 and the 3¾ gives 1255. The rating is based purely on speed.

The load is designated as a target proposition, and the samples I received from the factory spoke of the usual Winchester quality control in manufacture. For instance, the shot count in the number seven load averaged out at 384 per load, which is exactly the required nominal figure. In other words, it is accurately loaded, a good start.

The value of the low velocity cartridge for target shooting cannot be overestimated in the hands of average and highly competitive shooters alike. All around the world, trap has been shot successfully by cartridges producing velocities well under 1200 fps.

In looking at the 275, we are in fact now seeing two cartridges. There is little point in speculating on the actual powder used to load them, because Winchester has the facility to use blends that are unavailable to reloaders.

However, it doesn't matter in the least whether it's 452, or faster or slower in burning rate. What matters is that the factory can manipulate its blends for the consistency necessary for regular users to learn its performance in their own guns.

Testing indicated that the cartridge was loaded to 1150 fps, and a mean pressure of 9100 fps. This is moderate by SAAMI standards (of which I will write in detail in a future article). It is these, the American standards, to which Winchester adheres as a means of gaining worldwide quality control.

Why is it two cartridges?

As it comes in shot sizes seven and nine only, the two targeted buyer groups are obviously Down the Line and skeet shooters.

Consequently, it comes as no great surprise to find that the sevens come with the white AA wad and the nine use the AA wide pattern.

This becomes a complication, but not a bad one.

Modern skeet guns, anything other than those with a fairly positive degree of choke which they used to have many years ago, in my experience tend to pattern very similarly from one cartridge to another. Put another way, it's practically impossible to get a skeet gun with a retro choke, or a true cylinder bore, to tighten its patterns. It will resist efforts to tighten up because there is no constriction there for the shot to catch onto at all.

I have to add here that the skeet and cylinder are the only chokings that in my experience are so incapable of changing their patterns with a different diet of components. Now, if you shoot skeet with an improved cylinder, a gun with some small quantity of choke, however negligible it may be, then you do stand to benefit from the wide pattern wad, which will help to override it and give the rapid spread needed for the close ranging skeet targets.

In this way it is easy to understand Winchester's thinking in using the wide pattern wad in the skeet cartridge. There is nothing to lose, and there may well be something to gain, depending on the particular gun in use.

The advantage that this cartridge offers for skeet is that it is offering the lowest recoiling performance on the factory loaded market. In any competition this aspect is

just too often overlooked, but a lot less often by the winners than the losers.

Compare it with a faster cartridge. At the twenty metres' breakage of most skeet targets, the slightly reduced velocity of the 275 has no harmful effect whatever on the ability of the load to break the targets; at the same time it recoils less, and is probably going to pattern the same as a harder kicking cartridge. No contest. Among the current range of factory loads I'd use it for preference without hesitation.

It has a place in simulated field as well, just a couple in the loops of your shooting jacket to deal with the close, fast birds, particularly where you need quick recovery for the second barrel.

In looking at the number seven load, we have a different question to confront.

The trap shooter is not blessed with a choke that makes for high quality patterns regardless of what diet he feeds his gun on. If he has, say, an improved modified first barrel, he may have to do a little work in matching cartridge to gun, because such tighter than moderate levels of choking do get patterns to want to head into the area of overtight percentages and inefficient distribution — unless some preventive measures are taken in patterning to find the most suitable combination.

On the other hand, the fifteen metre Down the Line specialist is very much in need of a low recoiling first barrel load, and will benefit from the quicker realignment time if he has to use the second barrel. Just as much as the skeet shooter, he will benefit from the decreased pounding his nervous system has to soak up from recoil.

In the States, the demand for such loads has steadily increased, and extends to 12 gauge one ounce jobs at the same 1145 fps, and the reloading manuals are full of them. They do the work at fifteen metres without any question whatever.

Pattern testing of the 275s in sevens demonstrated that the cartridge when properly used is a delight. Only misuse by the shooter can interfere with their potential. And any cartridge can be misused.

Let me explain. The pattern efficiency scale is able to be broken down into what amounts to five sections — poor, fair, average, good and excellent. Remember, this has nothing to do with pattern percentage, which is a register of how tight the choke is. It is a measure of how well distributed a pattern is, regardless of choke.

Among the test barrels I used for this report, I selected three from different ends of the spectrum — .025", say improved modified, likely to be found in the first barrel of a trap gun; .014", say a light modified; and true cylinder. The last we have already covered. Patterns were just as I would expect from a cylinder — devastating. They always are. The skeet end is well and truly wrapped up.

The .025" improved modified barrel using sevens shot fairly tight (75%) full choke patterns with average to fractionally above average pattern distribution.

The .014" was a different story altogether. It shot to specifications, giving 58%, a light modified, and pattern quality improved noticeably to reach the high average bracket, enough to impart an advantage in the favour of the shooter.

Frankly, this surprised me. The shot used in the 275 is to my knowledge the hardest you can get in Australia, harder in fact than some Italian nickel plated that I compared it with. I rate it as the highest antimony content on our market, and this can mean the shot tends to centrally thicken the patterns.

The factory thinking here is not hard to work out. By reducing velocity to basic target speed they want to keep penetration to a maximum, and so use the hardest shot.



## NORMANTON GUN CLUB

### ANNUAL SHOOT 28th & 29th MAY

As always with shotguns, there is a trade off, and in this case it goes like this. Harder shot retains energy and patterns tighter down range, but if put through too much choke it will bunch the shot up in the middle. There is a perfectly easy way out of this — use less choke.

As a result of my testing I am very pleased to recommend the 275 — I think it is a boon to target shooting. However, if you simply swap over to it from, say 325s, there's a likelihood you may not get the best out of it because your patterns will be prone to tighten up.

In the States, they've recognised this phenomenon for years. It makes me wonder when Australian shooters will wake up to it. The way to go to get the very considerable benefits of this cartridge is to reduce choke to suit it. Any reader with a trap gun too heavily choked to give best results with these low recoiling moderate loads need only have a little choke removed to get the required pattern distribution. About .015" is getting close for good half choke patterns. If you're not confident about a gunsmith who can do a competent job, write to me here at the magazine with a stamped addressed envelope and I'll recommend a couple.

The other group in the shooting community who could readily adopt the 275 with some benefit is the simulated field shooters. Many folk these days have a set of choke tubes at their disposal. The 275 is ideal through an improved cylinder tube, and will give first class results on targets from 25 to 40 yards, which is where most simulated field shooting is done — and, once again, reduce recoil related fatigue, and allow a quick recovery for the second barrel.

At present the 275 has been reinstated in sevens and nines only. I would hope to see it come out in eights, with the standard AA wad, and feel this would increase its usefulness further, both for first barrel trap and particularly for first barrel simulated field.

And what's more, it comes in that tirelessly reloadable gold case. I hope the demand stays high. It's filling an entirely empty gap in the market.

*This article is copyright Ron Forsyth and first appeared in the Australian Shooters' Journal, November 1987. This article is used with permission.*

#### TRADE PRACTICES ACT

The attention of advertisers is drawn to the Trade Practices Act 1974 and the provisions in the Act which apply to advertising. It is not possible for the A.C.T.A. to ensure that advertisements which are published in this magazine comply in all respects with the Act and the responsibility must therefore be on the person, company or advertising agency submitting the advertisement for publication. The A.C.T.A. reserves the right to refuse any advertisement without stating the reason.

Twenty-nine shooters competed in the night program which consisted of the North Qld Zone S.B. C'ship. The overall winner was Jim Edmonds (Mt Isa) with a score of 24/25. A Grade Rod Cusack (Mt Isa) 22/25; B Grade Peter Weder (Normanton) 19/25; C Grade Diane Reeves (Normanton) 22/31; D Grade John Wilkes (Karumba) 18/25; Best Lady Carole Weder (Normanton) 14/25; Best Junior Brenda Schneekloth (Normanton) 14/25. This event was sponsored by Pacific Dunlop Batteries, Townsville.

Event 2: Qld. State D.Doubles C'ship. This event was sponsored by Repco Autoparts, Cairns and was won by Jim Edmonds (Mt Isa) and Ron Keyes (Cloncurry). Second place going to Rod and Robbie Cusack (Cloncurry).

The weather continued to be pleasant with a strong breeze on Sunday morning with 26 shooters competing. Event 3: 10t DB Points Cash Divide saw Wayne Mann (Karumba) shoot the only possible and second place going to three shooters on 27/30 — Rod Cusack, John Wilkes and Junior, Brenda Schneekloth.

Event 4: Gulf Country Points C'ship — winner Jim Edmonds collecting his 3rd Overall Sash and Trophy for the weekend with a score of 73/75. A Grade Rod Cusack 72/75; B Grade Peter Weder 63/75; C Grade Gordon Bell (Charters Towers) 64/75; D Grade John Wilkes 62/75; Best Lady Diane Reeves 63/75; Best Junior Brenda Schneekloth 46/75.

Event 5: Carpentaria DB C'ship. Overall in this event went to our secretary, Diane Reeves 24/25; A Grade Kevin Pearce (Cessnock N.S.W.) 25/27; B Grade Ron Keyes 19/25; C Grade Gordon Bell 23/25; D Grade Kevin Robinson (Cairns) 23/25; Best Lady Brenda Schneekloth 19/25; Best Junior Rachael Sellings 17/25.

Event 6: Annual DB H'cap Event (Calcutta) was won by Rod Cusack 24/24 who also gained another metre for his win. Second went to Gordon Bell 33/35; third Chris Gillham (Normanton) 32/35 after a shoot off for 2nd and 3rd which involved five shooters. Front Marker prize (dinner for two at Christine's Restaurant, Karumba) was won by Brenda Schneekloth 23/25.

The Overall High Gun was won by Rod Cusack by one point from Jim Edmonds. The "Carpentaria Classic" ended in a tie between Rod and Jim on 118 points. After several rounds of shoot off targets Rod Cusack emerged the winner.

Other High Gun winners were: A Grade Jim Edmonds 164/180; B Grade Peter Weder 143/180; C Grade Diane Reeves 138/180; D Grade John Wilkes 151/180; Ladies Carole Weder 105/180; Junior Brenda Schneekloth 129/180.

This year saw the club able to use two layouts with identical trap houses and two Hitraps installed, both layouts under lights which speeded up the program and allowed travellers to leave for home on Sunday afternoon with plenty of daylight.

The club members and committee would like to thank all sponsors and trophy donors for contributing towards our annual shoot which boasted \$2,000 in prizes and trophies.

Visiting shooters for the weekend came from Karumba, Cloncurry, Mount Isa, Richmond, Charters Towers and Cessnock N.S.W. for which we thank you once again for your company.

The last section of improvements now completed at the grounds, we are in readiness for the Zone Trap Carnival to be held at Normanton in Easter 1989. We hope to see as many shooters as possible visit our club, catch a barra and break a clay in '89.

See you in the Gulf . . . WAYNE REEVES.

# W.A.C.T.A. REPORT

Over half the shooting season past, and time to reflect on the goals you set, and have you achieved these? Not only on the tracks, but also for your club. At W.A.C.T.A. level one of these goals was the formation of the five year forward development plan and the implementing of this. The first stage is underway with our submission to the Department of Sport & Recreation, for the July 1988-June 1989 season. D.S.R. invited all association presidents to a meeting for discussion on funding and the announcement of the D.S.R. country package approved by the minister. A very informative meeting and an indication from the government of their increased commitment financially and in all other aspects of our sport. Club secretaries should by now be well informed of what is available, and the avenues to take. If unsure contact your regional D.S.R. office.

The commitment by A.C.T.A. and release of a property debenture program is highly commended by your executive. One hundred and fifty one thousand dollar debentures with a maximum of term of ten years at 7½% is a means of raising the additional funds to purchase a property in a location best suited for its purpose. On a state share basis, 21 units is not much to ask from clubs or individuals to support a sport that has, and will continue to give you many hours of enjoyment. Your executive in support of this venture have purchased a debenture.

The executive meeting was held on the 11th June. All clubs should have the minutes. I urge all members to read these.

Exmouth responded to a request for a date change of their Coral Bay Championships. I personally pledged my support along with fellow competitors to this event when held at a later date.

We should know by the time this goes to print if the bid for the 1991 World Shotgun Championships is successful.

A promotional video compiled by the W.A.G.C. has been finalised. The executive previewed this and commends W.A.G.C. President, Mr T. Morony, his committee, and Mr R. Wagland in documenting a very professional video that all clubs should have. It is an excellent avenue for gaining new members.

Congratulations to Jim Scott on his election as A.C.T.A. President. Immediate past President, Mr Roy Holtfreter, announced his retirement from the W.A.C.T.A. Executive. A face we will certainly miss, not only for his wealth of knowledge, some 34 years of Clay Target involvement, but his sound reasoning at all levels of discussion. On behalf of the executive and all State Members, Roy, thank-you for your unselfish dedication. Welcome to Trevor Smith, Northam Gun Club President onto the executive.

## Around the Traps

I had the pleasure to attend the Kalgoorlie two day carnival on the 4th and 5th June. A most enjoyable weekend. A. Hocking proving too good for the field, winning A Grade 99/100 on the first day, and taking out the overall high gun in a field of 75 shooters.

C.M.T. were host for the state I.S.U. Skeet title. Twenty-eight shooters competed in the very trying conditions. The overall winner was A. Forsberg 201/225, with J. Carbone shooting 25/25 in the final round to draw within one target of the leader. State team comprises: J. Harris, A. Forsberg, J. Carbone, D. Kevill, J. Coci.

The inaugural inter zone W.A.I.S.U. Skeet Shield created added interest for all competitors. Thanks to J. Coci and B. Day for the donation of this magnificent shield. Congratulations to all the competitors.

The I.S.U. sub-committee has been active under the leadership of Chairman, Mr R. Thomson, and Secretary, Mr. P. Melvin. A meeting was held at Cunderdin on the Saturday of the State Skeet weekend. I attended this

meeting and I'm pleased to report the direction the committee is following, plus the enthusiasm of all competitors augurs well for the I.S.U. in the future.

It won't be long before our October Carnival is upon us. Sponsorship is an important part of our budget requisites. If you can assist, please contact myself, or our ever efficient State Secretary, Mr R. Arlow.

Until next month,

J. Fissioli,  
W.A.C.T.A. President.

## FOR SALE BROWNING BELGIUM TRAP F

Excellent Condition  
Beautiful wood, cased

**\$3,000.00 FIRM**

Phone: (03) 386 6757 A.H.

## FOR SALE

Perazzi S.C.O. Side plates trap.  
One of only six in Australia.

Hardly used, in mint condition. Fully cased  
with spare kit, at less than half replacement  
cost **\$9,500.**

Browning C2F Grade Trap 71 action. Hardly  
used, in mint condition. Cased **\$6,750.**

Telephone A.H. (02) 371 4115

## BROWNING'S FOR SALE

A-1 TRAP FULL & FULL	NEW \$3700
A-1 TRAP ¼-¾	NEW \$3700
D3 (J) ¼-½	MINT \$11,000
AT SKEET BELGIUM MADE	NEW \$2800
GRADE 4 BAR 7mm	NEW \$2850
C2 SKEET	MINT \$6000

Steve Williams: (068) 82 7980

## Green or Gold Caps

with Australia Badge

available in mesh or enclosed styles.

**\$7.40** including postage

Please send cheque  
(made payable to A.C.T.A.)

National Office,  
P.O. Box 800, Glen Waverley, Vic. 3150



# MARYBOROUGH TIT BIT

Local shooters to attend Townsville G.C. April 30/May 2, and to make an impression were Allen Harris who made the possible, but didn't continue. Bad luck Allen. Troy Harris (junior) shot equal third in Junior State Team and second in the Single Barrel . . . good shooting Troy.

From Bundaberg Rob Rehbein obtained fifth Qld State Team & 6th in Qld. His wife, Kaye, blazed her way to 2nd Ladies State Team, 1st Qld DE C'ships and places in the SB & Points C'ships. It is because of shooting like this that Bundaberg honored her with being sportsperson of the month, proudly sponsored by radio station 4UB and Crystal Gem.

After sending shooters to see local member with references to gun laws, we thought we had enough on our plate. However, watching local news on TV, a man came on with a 90 signature petition to have our club banned to the bush as he didn't like the noise. With the gun laws and the petition to shift us, we hit the panic button. Quick thinking by someone, we obtained the petition list and four shooters went off and interviewed them. Would you believe 98% said they didn't care and signed because they lived in the area and didn't want to make enemies.

Things didn't end there. That same afternoon our generator blew up. As our original coverage was well looked after with the help of AMP and a premium of \$16,000 we thought we were right, but no, we didn't have fusion, so I don't know what else you could cover a generator for. Thanks to the workers for getting the replacement motor in time for the next shoot which was May 22. This shoot saw visitors raid the cash box in the 100t Cont. CD. O/A: B. Gino Sergiacomi, C Grade 1st Frank Agius, Spencer Plath 2nd, Rob Rehbein O/A . . . all Bundy shooters.

Talk around the traps is that Hervey Bay is to build their own shooting complex, so I asked around to find out if it is going to be a floating complex like the hotel at Cairns. Reason being the lost bird wouldn't break on impact. Well that sounds alright now, but how would you pick them up?

Till next time see you around the traps.

Lost Bird.

## RIVERINA ZONE CARNIVAL 1988

Tumut Gun Club in conjunction with Riverina Zone attracted shooters from Cowra, Cooma, Canberra, Boorowa, Wangaratta and twelve Riverina Clubs to shoot in ideal conditions. There are 10 juniors vying for position and five lady shooters.

Tumut Bicentennial Sports Council generously donated eleven Bicentennial Sports Badges and a certificate to all shooters who nominated on the day.

The John O. Cox Memorial Shield, donated to the Zone by the Mangoplah Gun Club to be shot on the double barrel event by zone teams was contested by nine clubs. The winning team of T. Salafia, A. Paonne, S. Papisidero, N. McDermott and C. Salafia from Leeton shot a perfect 125/125 to win. What a score to put on it for starters! Congratulations guys!

Nineteen shot the possible in the Zone Double Barrel Championship. D. Fairall was the overall winner with 137/137. AA went to T. Salafia from J. Smith; G. Pinner won A Grade from S. Papisidero; B Grade went to P. Englebrecht from Grant Cleely second; A Sanders was second to I. Peacock in C Grade; A. Pearce and D. Willett were first and second in Juniors; the veteran winner was Bill Mackay. The Ladies Zone Double Barrel was won again by Maree Rooke with 25/25 from Joan Longmore second.

Zone Points Score Championship was won by R. Piotrowski from Cowra with 99/99. AA went to G.

AUSTRALIAN CLAY TARGET NEWS — AUGUST 1988

Thatcher from F. Schmetzer; A. Paonne took A Grade with Bill Mackay second; D. Blewitt won B Grade, K. Male coming in second; S. Polsen was second to R. Willett in C Grade; the top junior was A. Pearce and Lyn Blake was the winner of the ladies division.

Leeton's well known Chris Salafia was overall winner of the Zone Single Barrel Championships; J. Smith and P. Mason were first and second in AA Grade; A went to Bill Mackay from G. Pinner; Joan Longmore won B Grade from fellow clubman R. Schubach; M. Monteleone was second to M. Casnave in C Grade; Junior winner was B. Leonard; Maree Rooke won the ladies putting her one point ahead of Joan Longmore in the team score and two points ahead for the ladies high gun. The overall high gun was won by A. Paonne with 128/130. The veteran's high gun went to Bill Mackay and the juniors to D. Willett.

Qualifying scores were higher in all divisions this year. Keep it up shooters and let's hope for at least one winning team at the State Carnival at Sydney in October. Good shooting and good luck!

## SINGAPORE AIRLINES PERPETUAL TROPHY

Champion of Champions held at Wakehurst Gun Club, Narrabeen.

Seventy two enthusiastic trap and skeet shooters competed for the fifth year in succession to win Singapore Airlines' Perpetual Trophy "Champion of Champions".

This competition was held at the Wakehurst Gun Club on May 29 in cold and windy conditions.

The contest was shot over 55 mixed targets; 10t Single Barrel, 10t Double Barrel, 10t Pointscore and 25t Skeet. The popularity of this trophy caused some concern at Wakehurst, this being a one only down the line skeet layout. The club could not keep up with the demand of shooters wanting to take part and some late comers had to be turned away due to limited time available.

This year's Singapore Airlines Trophy for overall best marksman was won by an A Grade shooter, Nick Lougas with a score of 71/75. The A Grade prizes went to: 1st Ron Beer 67/75, 2nd A. Michael 66/75. B Grade prizes went to: 1st E. Stano 64/75, 2nd G. Petrou 60/75. C Grade was won by P. O'Hanessian 63/75 followed by P. Lewer 2nd with a score of 60/75.

On hand to present the trophies to the winners were Mr John Howse, Sales Manager N.S.W. for Singapore Airlines and Mr Charles Abela, District Sales Manager, Sydney, and a long time member of the Wakehurst Gun Club, together with Mr Ray Cerny, President of Wakehurst.



Back Row: R. Beer, John Howse (Sales Manager, Singapore Airlines), E. Stano, P. Lewer, P. O'Hanessian.  
Front Row: A. Michael, G. Petrou and N. Lougas — Overall Winner.

# IMPORTANT NOTICE

## 1989 NATIONAL CHAMPIONSHIPS

THE RICH RIVER ACCOMMODATION ASSOCIATION  
welcomes all competitors to ECHUCA and MOAMA for

### THE AUSTRALIAN NATIONAL CLAY TARGET CHAMPIONSHIPS

Pre-Nationals Thursday & Friday March 30 & 31  
Nationals Saturday April 1 - Thursday April 6.

*Our Association is proud to be sponsors to the Pre-Nationals High Gun.*

Be sure of your accommodation — book now at any of the following motels:

<b>MOAMA CENTRAL</b>	82 5377	<b>PORT OF ECHUCA MOTOR INN</b>	82 5666
Rhonda & Peter Griffiths	Cobb Highway, Moama	Barbara & Keith Rowland, Derek & Beverley	High Street, Echuca
<b>MOAMA SPORTSLANDER</b>	82 4366	<b>MOAMA MOTOR INN</b>	82 3311
Gary, Ann & Cyril Langdon.	Perricoota Rd, Moama	Maureen & John Baker	Cobb Hwy, Moama
<b>CADELL COUNTY MOTOR LODGE</b>	82 4500	<b>SETTLEMENT MOTOR INN</b>	82 4777
Geoff & Marg Evans & Geoff Stone	Perricoota Rd, Moama	Janet & Bazil Shields	405 High St, Echuca
<b>CAMPASPE MOTOR INN</b>	82 3900	<b>NIREBO MOTEL</b>	82 2033
Kathy Illingworth & Evelyn & Ron Bollard	305 Ogilvie Ave, Echuca	Corale & Don Oberin	251 Hare St, Echuca
<b>ECHUCA PHILADELPHIA MOTOR INN</b>	82 5700	<b>COUNTRY ROADS MOTOR INN</b>	(058) 52 3577
Stephen & Sue, Laurie & Daphne Brown	Ogilvie Ave, Echuca	Jenny & Robert Rofe	Kyabram 3620
<b>THE OLD COACH MOTOR INN</b>	82 3155	<b>HIGH STREET MOTEL</b>	82 1013
Lorraine & Ron O'Brien	292 Ogilvie Ave, Echuca	Christine & Neil Ramsay	439 High St, Echuca
<b>PEVENSEY MOTOR LODGE</b>	82 5166	<b>ECHUCA MOTEL</b>	82 2899
Geoff & Marlene Hemingway	High St, Echuca	Sandra & Gerard O'Conner	Ogilvie Ave, Echuca
<b>RICH RIVER COUNTRY CLUB</b>	82 4411	<b>BIG RIVER MOTEL</b>	82 2522
Wendy & Ian Hardinge	24 Lane, Moama	Eric & Sandra Grumont	317 High St, Echuca
<b>STEAMPACKET MOTEL</b>	82 3411	<b>HOPWOOD MOTOR INN</b>	82 2244
Sue & Jim Hawkins	610 High St, Echuca	Ken & Myrtle Rooks	Northern Hwy, Echuca
<b>"MURRAY HOUSE"</b>	82 4944	<b>RED GUM MOTOR INN</b>	(058) 84 3404
Ann & John Campbell	Francis St, Echuca	Tina & Karl Barabas	Cobb Hwy, Mathoura 2710
<b>RIVER COUNTRY INN</b>	82 5511	<b>MOTEL ROCHESTER</b>	(058) 84 1077
Rae & Ross Veale	Cobb Hwy, Moama	Roslyn & John Cecchin	24 Echuca Rd, Rochester 3561
<b>PADDLE WHEEL MOTEL</b>	82 3298	<b>MOTEL NATHALIA</b>	(058) 66 2615
Lyn & Doug Foster	385 High St, Echuca	Jan & Don Cunningham	Murray Valley Hwy, Nathalia 3638
<b>FOUNTAIN MOTEL</b>	82 3200	<b>RIVERBOAT LODGE</b>	82 5777
Jim & Trish Nolan	Northern Hwy, Echuca	Pam & Geoff Andrews	High St, Echuca
<b>ALL RIVERS MOTOR INN</b>	82 5677	<b>CALEDONIAN HOTEL/MOTEL</b>	82 2100
Ken, John & Phillip John	Northern Hwy, Echuca	Bev & Lance Vagg	110 Hare St, Echuca
<b>RED CARPET INN</b>	82 4244	<b>KYABRAM MOTOR INN</b>	(05) 52 2424
Asip & Asim Memishi	Northern Hwy, Echuca	Angela & Henry Wallard	Kyabram 3620
<b>RIVER VILLAGE MOTEL</b>	83 5333	<b>BORDER INN HOTEL/MOTEL</b>	82 2666
Heather & Dennis Sullivan	Bangerang Rd, Echuca Village	Alan Ash	Cobb Highway, Moama
<b>WINBI RIVER RESORT MOTEL</b>	82 3044		
Gwen Roders & Bernard Trethowan	Perricoota Road, Moama		

*For further information please phone (054) 82 5254 . . . (054) 82 6001*

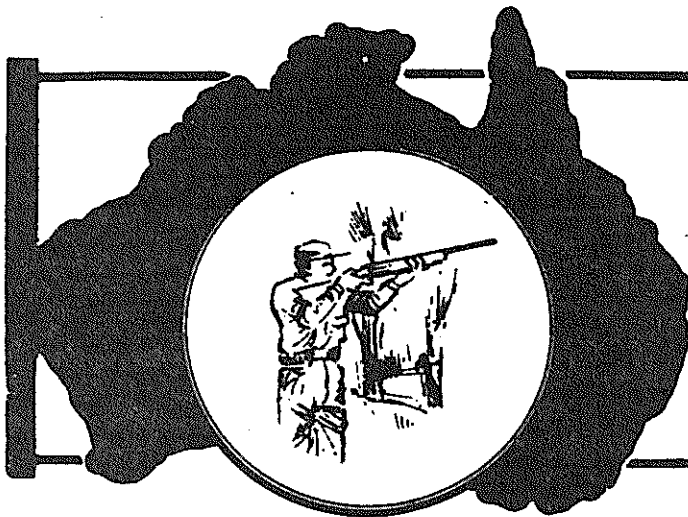

## CLUB NEWS, PROGRAMS AND RESULTS.

Northern Territory.....	18	New South Wales.....	33
Western Australia.....	18	Victoria.....	43
South Australia.....	21	Tasmania.....	55
Queensland.....	24		

## CLUB NEWS

### MORWELL GUN CLUB

The Club held its Annual General Meeting 25.5.88 and the new office bearers are as follows: President — Bruce Webb; Senior Vice President — Gerry Petruska; Junior Vice President — Jim Hollands; Secretary — Fiona Firth; Treasurer — Malcolm Firth.

### WAGGA GUN CLUB

Annual General Meeting was held on 30th May, 1988 and the following committee elected: President — Barney Rooke; Vice President — Bruce Tingle; Secretary/Treasurer — Andy Sanders; Promotions Officer — Barney Rooke.

### SCRUBBY CREEK GUN CLUB

At the Annual General Meeting held on Sunday, 12th June, 1988 a new committee was elected: President — S. Picone; Vice Presidents — M. Doyle, A. McPherson; Secretary/Treasurer — R. Doyle; Shoot Captain — I. Peckett; Asst. Shoot Captain — W. Bryant, N. Johnston.

### KEMPSEY GUN CLUB

The following were elected at the Annual General Meeting held on 25.6.88: President — Bert Edwards; Vice President — Colin Crighton; Secretary — Jan Edwards; Treasurer — Edward Baker; Committee — Glen Baker, Frank Buchanan, Rowley Booth.

### KERANG CLAY TARGET CLUB INC.

At the Annual General Meeting of K.C.T.C. the following office bearers were elected: President — Frank James; Vice President — Bob Williams; Junior Vice President — Ken Burton; Secretary/Treasurer: Faye Burton.

### V.C.T.A.

The Victorian Clay Target Association notifies members of the change of Office Bearers resulting in: President — Glen Woodhatch and Vice President — Len Cook.

### VALE: RAY HERBERT BATH

Ray Bath, a Life Member of the Geelong Clay Target Club, passed away suddenly at home on 13 June 1988, at the age of 67.

Ray will be remembered for his cheerful disposition, his love of a good yarn and the fact that he was the longest-serving member of the club.

● He had not been in the best of health over the last few years and underwent a series of major operations, with the prospect of more in the future.

Ray won many trophies over the years, his best effort being 107 single barrels at Ballarat some years ago.

Ray will also be remembered for his skill as one of the world's fastest rabbit skinner. He could skin and peg a pair of rabbits to export standard in less than a minute.

He is survived by his wife Dorothy and son Colin, who are also Life Members of the club. Grandson Paul is also a member and is already showing some of the skill of his father and grandfather.

Ray will be sadly missed by friends, club members and the shooting fraternity.

# NORTHERN TERRITORY STATE SKEET CARNIVAL

**Venue: Darwin Gun Club**

**Date: September 17 & 18, 1988**

**Start: 9.00a.m.**

## Program:

- |                |                                 |                     |
|----------------|---------------------------------|---------------------|
| <b>EVENT 1</b> |                                 | <b>Nom. \$10.00</b> |
|                | 25 Target Eye Opener            |                     |
| <b>EVENT 2</b> |                                 | <b>Nom. \$20.00</b> |
|                | 50 Target Marara Handicap       |                     |
| <b>EVENT 3</b> |                                 | <b>Nom. \$20.00</b> |
|                | 50 Target Arafura Championships |                     |
| <b>EVENT 4</b> |                                 | <b>Nom. \$25.00</b> |
|                | 50 Target Night Championships   |                     |



**Sunday 18**

- |                |                                    |                     |
|----------------|------------------------------------|---------------------|
| <b>EVENT 5</b> |                                    | <b>Nom. NIL</b>     |
|                | 50 Target State Skeet Postal Match |                     |
| <b>EVENT 6</b> |                                    | <b>Nom. \$20.00</b> |
|                | 50 Target State Skeet Championship |                     |

High Gun on events 1-6 — Two man team (Tristar trophy) events 1-6 — State team 15 man selected on events 2 & 3 — State Team high Gun shoot off follows immediately — State badges for team members

**For information ring: (089) 27 3990**  
**Written enquiries: P.O.B. 41121,**  
**Casuarina, 5792 N.T.**



**NORTHERN TERRITORY**

**DARWIN 3-6-88** — Pleasant, dry night. 20T DB: A: K. Selwood 25-25; B: J. Bell 19-20; C: P. Wheeldon 20-22. 20PR DR: A: P. Grove 35-40; B: J. Bell 29-40; C: M. Warren 27-40.

**DARWIN 5-6-88** — 25T Trench: K. Selwood 24-25. 20T PS: A: K. Selwood 58-60; B: K. Bathman 55-60; C: L. Grove 43-60. 50T SB: A: K. Selwood 44-50; B: P. Hoare 41-50; C: L. Grove 37-50. 30T DB: A: B. Devine 40-41; B: K. Bathman 22-30; C: V. Padovan 26-31. 25T Tower: 1st T. Weis 30-31, 2nd P. Grove 29-31.

**DARWIN 19-6-88** — Fine (smokey). 25T Skeet: K. Bathman 23-25, J. Millington 23-25. 20T PS: A: K. Selwood 60-60; B: J. Bell 57-60; C: V. Padovan 59-60. 50T Thies Toyota SB: A: P. Grove 45-50; B: P. Hoare 41-50; C: L. Grove 40-50. 10PR DR: A: G. Chan 25-30; B: J. Bell 14-20; C: M. Risk 18-30. 50T Trench: A: K. Selwood 53-60; B: B. Fox 39-50; C: V. Padovan 40-60.

## To: Australian Clay Target Association

P.O. Box 800, Glen Waverley, Vic. 3150

*Please note my Change of Address*

Name: .....

From .....

..... P/code .....

To: .....

..... P/code .....

Membership No.: .....



**WEST AUSTRALIA**

**ALBANY 22-5-88** — Overcast & wet (8). 25T Cont: 1st R. Abbott 19-25, 2nd D. Slee 18-25. 25T Hep: 1st R. Abbott 24-28, 2nd A. Ferguson 23-28.

**ALBANY 12-6-88** — Overcast & wet (7). 50T Skeet Club C'ship: 1st D. Slee 48-50, 2nd G. Fitzpatrick 47-50.

**BUNBURY 22-5-88** — Fine (30). 100T Skeet: OA: G. Hyder 95-100; A: 1st B. Day 95, 2nd J. Coci 95; B: 1st J. Tetlow 93, 2nd S. Silvi 93; C: 1st J. Lange 92, 2nd L. Johnston 88. Club champion: G. Hyder.

**BUNBURY-88** — 4-6-88 — Fine (19). 25T SB Tower: 1st A. Harvey 25-25, 2nd D. Wetherell 34-36, 3rd C. Linaker 33-36. 25T A.T.A.: BM: C. Hyder 23-25, R. Silvester 22-25; FM: C. Linaker 23-25, A. Sullivan 21-25.

**EASTERN GOLDFIELDS 4-6-88 & 5-6-88** — Fine (85). Kalgoorlie Businessmen's Classic 100T: OA & A: A. Hocking 99-100, D. Kevill 98-100, M. Cubic 110-113; B: J. Hartley 95-100, A. Brown 99-105, B. Edgar 98-105; C: B. Couzens 99-100, D. Fracaro 89-100, T. Watson 88-100; Ladies: J. Wood 81-100; Juniors: S. Couzens 87-100. 25T Cartridge Hep: 1st L. Naylor 34-34, 2nd G. Cammoek 33-34, 3rd A. Hocking 35-36; unplaced meterage, 11-15: M. Rowell 32-34; 16-18: J. Hartley 34-36; 19-25: N. Johnson 24-26. 25T DB Pts District C'ship: OA & A: L. Shipp 75-75, D. Weisse 74-75; B: C. Johnson 72-75, G. Cammoek 71-75; C: L. Watson 66-75, S. Couzens 80-81. Hungry Jacks Kalgoorlie Whopper 25T DB: OA: L. Naylor 126-126; A: D. Weisse 125-126, B. Vodden 58-59; B: L. Naylor 126-126, B. Edgar 41-42; C: J. Rayner 24-25, G. Shipp 23-25. OA HG: A. Hocking 218-225. Ladies HG: J. Wood 201-225. Juniors HG: S. Couzens 196-225.

**ESPERANCE BAY 29-5-88** — Fine, light wind (18). 25T DB Hep: 1st R. Henley 24-25, 2nd E. Burchard 25-27, 3rd L. Naylor 24-27. 25T DB Continental 15m: 1st J. Locke 24-25, 2nd H. Miller 25-27, 3rd E. Burchard 24-27.

**GERALDTON 29-5-88** — Fine & sunny (27). 5PR DR EO: J. Griffiths 9-10, M. Watson 9-10. 10PR DR: A. Hocking 19-20, J. Griffiths 17-20, M. Watson 17-20, B. Boschetti 17-20. 10PR DR: J. Oliveri 18-20, R. Baker, M. Watson, E.

**AUSTRALIAN CLAY TARGET NEWS — AUGUST 1988**

Toomey, S. Johnston, G. O'Brien, B. Boschetti, all 16-20. 10T DB was won after a shoot-off by G. Kelly. 10T DB Pts was won after a shoot-off by J. Lowe.  
**GERALDTON 12-6-88** — Fine & cloudy with S.W. wind (26). 25T Skeet: D. Wellington 25-25, R. Baker 25-25. 25T Skeet: D. Wellington 24-25, P. Miragliotta 24-25, D. Hilsz 24-25. Extra event, 25T ISU Skeet Novelty: M. Hatch 21-25, J. Hartley 21-25, D. Hilsz 21-25.  
**NEWMAN 27-3-88** — Fine & warm (10). 10T EO Hop: 1st T. Genge 9-10, 2nd

## EASTERN GOLDFIELDS GUN CLUB INC — ANNUAL TWO DAY SHOOT

The Eastern Goldfields Gun Club held their annual two day shoot over the long weekend, which proved a triumph for Geraldton marksman, Alan Hocking.

Hocking won the overall High Gun sash and trophy with a score of 218/225. Kalgoorlie's Julie Wood was overall winner in the women's division with a score of 201/225 and Scott Couzens took off the Junior High Gun scoring a total of 196/225.

A total of 85 clay target enthusiasts from throughout the Goldfields and other parts of the state, including Geraldton and the metropolitan area contested the annual shoot which opened Saturday with the 100 target Kalgoorlie Businessmen's Classic.

This event was shot over 15 metres in four lots of 25 targets and carried \$3000 in prize money. Hocking won overall and 1st in A Grade with a score of 99/100, 2nd was David Kevill (Quairading) 98/100 and 3rd in A Grade was Max Cubic (Collie) after a shoot off scoring 110/113.

Jack Hartley (Geraldton) won B Grade shooting 95/100. A shoot off was needed to separate 2nd and 3rd, Allan Brown (WA Gun Club) was 2nd with 99/105 from B. Edgar (Lancelin) 98/105. C Grade saw Bob Couzens (Southern Cross Gun Club) win with 93/100 from Dino Fracaro (WA Gun Club) and 3rd Toni Watson (Geraldton) 88/100.

Kalgoorlie's Julie Wood took off ladies with a score of 91/100, and Scott Couzens (Southern Cross Gun Club) won Juniors with a score of 87/100.

That concluded Saturday's shooting.

The first event Sunday was 25 targets Cartridge Handicap. A shoot off was needed to separate 1st and 2nd seeing Laurie Naylor (Esperance) winning with 34/34, 2nd was Gordon Cammock (Geraldton) 33/34 and 3rd Alan Hocking (Geraldton) with 35/36 after shooting off.

Unplaced meterage trophies went to 11-15 Mick Rowell (Kalgoorlie) 32/34, 16-18 Jack Hartley (Geraldton) 34/36 and 19-25 Neil Johnson (Leonora) 24/26.

A 25 target double barrel points score over 15 metres represented a district Championship and in A Grade and overall saw Lex Shipp (WA Gun Club) shoot the only possible 75/75, 2nd in A Grade went to Darryl Weise (Narrogin) 74/75. B Grade was won by Chad Johnson (Leonora) 72/75 and second B Grade Gordon Cammock (Geraldton) 71/75. 1st in C Grade was won by Leslie Watson (Geraldton) 66/76 and 2nd Scott Couzens (Southern Cross Gun Club) 80/90.

The final event was the Hungry Jacks Kalgoorlie Whopper 25 Double Barrel. Overall Laurie Naylor (Esperance) won after a shoot off which went for 126 targets, Naylor's score 126/126. 1st A Grade Darryl Weise (Narrogin) 125/126, 2nd A Grade Brendan Vodden (Kambalda) 58/59. Laurie Naylor also won his grade, being B Grade, 2nd was B. Edgar (Lancelin) 41/42, the C Grade winner was Joe Rayner (Kambalda) 24/25 from Gaye Shipp (WA Gun Club) 23/25. In this event there were initially 10 possible 25/25s shot.

The committee once again would like to thank all the local business people who have supported the club for this weekend.

Local members contest for their next club shoot 25 DB Trap ACTA and 25 DB Trap 15m to be held on the 19th June at 2.00pm.

AUSTRALIAN CLAY TARGET NEWS — AUGUST 1988

# WESTERN AUSTRALIAN GUN CLUB (INC) SEPTEMBER CARNIVAL

**Saturday & Sunday  
17th & 18th September 1988**

**Friday 16th September —  
Practice 1.30pm**

**Saturday 17th September —  
9.00am Start  
Barrel Warmers 0745 to 0845**

## WHITEMAN PARK

- |                |  |                     |
|----------------|--|---------------------|
| <b>EVENT 1</b> | 25 Skeet Championship                      | <b>Nom. \$10.00</b> |
| <b>EVENT 2</b> | 50 State Skeet Championship                | <b>Nom. \$15.00</b> |
| <b>EVENT 3</b> | 20 Pr State Deauville Doubles Championship | <b>Nom. \$8.00</b>  |

**Sunday 18th September —  
9.00am Start  
Barrel Warmers 0745 to 0845**

- |                |   |                     |
|----------------|---|---------------------|
| <b>EVENT 4</b> | 25 Winchester D/B Points District Championship  | <b>Nom. \$10.00</b> |
| <b>EVENT 5</b> | 50 Target State D/B Championship  | <b>Nom. \$15.00</b> |
| <b>EVENT 6</b> | 25 Target Whiteman Park D/B Handicap  | <b>Nom. \$15.00</b> |
| <b>EVENT 7</b> | City versus Country Shoulder to Shoulder D/B Points<br>(5 man selected over events 4 & 5) | <b>Nom. \$15.00</b> |

Sashes awarded to overall winners of events 1 to 6. Ribbons will be awarded to grade winners of events 1, 2, 4 & 5. Events graded A.B.C. 1st, 2nd & 3rd each grade. High Gun sash will be decided on events 1, 2, 4, 5 & 6. High Gun winners will be awarded overall to Ladies, Juniors & Veterans. Optional Sweeps at \$1.00 per 25 targets will be conducted on each 25 targets of events 1, 2, 4, 5 & 6. Bar and catering facilities will be available during the weekend, hot showers and ablution facilities are available. Limited number of caravan sites.

**Free barbecue and happy hour on  
Sunday evening**

**For further information phone the Club  
Administration Officer: (09) 249 2013  
WAGC Shooting Grounds: Beechboro Rd  
Nth Whiteman Park, W.A.**

# NORTHAM & DISTRICTS GUN CLUB

## Island Farm Shoot

**Program**

**August 19, 20, 21**

**FRIDAY 19 2pm ONWARDS**

**EVENT 1** **Nom. \$11.00**  
Double Barrel Graded 25 Targets. Trophy 1st,  
2nd, 3rd Grades A.B.C.

**SATURDAY 20 9am**

**EVENT 2** **Nom. \$5.00**  
Single Barrel Eye Opener 10 Targets Cash 1st,  
2nd, 3rd

**EVENT 3** **Nom. \$11.00**  
Northam Town Council D/B District  
Championship 25 Targets  
Trophy & Sash for Overall winner. Trophy 1st  
& 2nd Grades A.B.C. Trophy best Lady, Junior  
& Veteran  
\$1.00 Opt. Sweep Graded

**EVENT 4** **Nom. \$11.00**  
S/B District Championship 25 Targets  
Trophy & Sash for Overall winner. Trophy 1st  
& 2nd Grades A.B.C. Trophy best Lady, Junior  
& Veteran  
\$1.00 Opt. Sweep Graded

**EVENT 5** **Nom. \$14.00**  
40 State Mixed Targets  
Trophy & Sash for Overall winner. Trophy 2nd  
& 3rd.  
\$1.00 Optional Sweep

**SATURDAY NIGHT MEAL AT CLUB  
HOUSE**

**SUNDAY 21 9am**

**EVENT 6** **Nom. \$11.00**  
Points Score District Championship 25 Targets  
Trophy & Sash for Overall winner. Trophy 1st  
& 2nd Grades A.B.C. Trophy best Lady, Junior  
& Veteran  
\$1.00 Optional Sweep Graded

**EVENT 7** **Nom. \$8.00 each**  
Commonwealth Deauville Doubles 20 Pr  
24 Metre  
Trophy & Sash Overall winners. Trophy 2nd &  
3rd.  
\$1.00 Optional Sweep

**EVENT 8** **Nom. \$16.00**  
Hannagan Rheem Perpetual Handicap Cup  
D/B Handicap 25 Targets. Trophy 1st, 2nd, 3rd  
Overall. Trophy best 14-15m, 16-17m, 18-20m,  
21m & over. Trophy best Lady, Junior, Veteran

**EVENT 9** **Nom. \$10.00**  
D/B Cash Graded 25 Targets  
1st, 2nd, 3rd each grade. 50% back each  
grade

**Overall Sash & Trophy — Overall Trophy  
Lady, Junior, Veteran**

N.B.: A.C.T.A. Handicap cards to be presented  
The committee reserves the right to alter the program if necessary

**ALL ENQUIRIES: PHONE TREVOR SMITH (096) 22 0250 — BRUCE MALEY (096)  
22 1460**

P. Stingel (Jnr), T. Stingel, T. Kezich all 7-10, 3rd Z. Musulin, C. Marevic, B. Pierce, M. Stone, P. Heath all 6-10. 25T DB Pts: 1st T. Stingel 66-75, 2nd M. Stone 59-75, 3rd T. Genge 58-75. 25T Skeet Graded: A: M. Stone 21-25; B: T. Stingel 23-25; C: T. Kezich 19-25. 1988 Continental C'ship: 1st & OA T. Stingel 24-25, 2nd T. Genge 17-25, 3rd M. Stone 20-30, 4th P. Heath 19-30.

**NEWMAN 10-4-88** — Fine & windy (8). 50T Skeet Graded C'ship: OA & B: T. Stingel 53-56, P. Robson 40-50; A: M. Stone 54-58; C: T. Genge 40-50, D. Bozovic 36-50. 50T Skeet Hop C'ship: 1st & OA T. Stingel 49-50, 2nd M. Stone 43-50, 3rd T. Genge 43-54.

**NEWMAN 24-4-88** — Fine & calm (13). 25T DB Hop: 11-15m: T. Genge 23-25, I. Sivak 22-25, P. Heath, D. Bozovic 21-25; 16-19m: P. Robson 23-25, M. Etone 21-25. 50T DB Hop C'ship: 1st & OA M. Stone 45-50, 2nd P. Heath 43-50, 3rd D. Bozovic 43-51.

**NEWMAN 1-5-88** — Warm & cloudy (8). 10T EO Hop: 1st T. Genge 10-10. 25T DB Graded: A: T. Stingel 23-25; C: T. Genge 23-25. 25T Skeet: 1st T. Stingel 24-25, 2nd M. Stone 22-25, 3rd T. Kezich, P. Robson 21-25. 50T Tower (Practice): 1st P. Robson 33-50, 2nd P. Heath, M. Stone 29-50, 3rd T. Stingel 25-50.

**W.A.G.C. 28-5-88 & 29-5-88** — Fine (91). 100T Skeet: OA: L. Hull 100-100; A: A. Yozzi 98-100, M. Middleton 98-100, C. Bertini 93-100; B: D. Hilsz 94-100, S. Hastie 89-100, S. Silvi 88-100; C: D. Whitlock 92-100, L. Johnston 91-100, G. King 89-100; OA Ladies: L. Johnston 91-100. 50T Bicentennial Skeet Hop: 1st T. Morony, 2nd J. Coci, 3rd K. Wilson, 4th W. Wiess, 5th D. Ayres, 6th D. Whitlock. 50T Bicentennial Skeet C'ship: OA: L. Chandler 49-50; A: K. Baker 48-50, D. Hilsz 48-50; B: J. Tetlow 48-50, G. Twine 48-50; C: B. Williamson 47-50, J. Philippoff 45-50. OA HG: L. Hull 191-200. OA Ladies HG: L. Johnston 177-200.

**W.A.G.C. 12-6-88** — Cool/blustery (10). 100T ISU Skeet Club C'ship: OA: A. Forseberg 90-100; A: J. Coci 80-100; B: C. Bertini 79-100, A. Carmichael 72-100; C: B. Epstein 78-100, S. Silvi 76-100.

**W.A.G.C. 18-6-88** — Fine/cool (35). 50T DB Trap: A: R. Bailey 49-50, M. Callaghan 49-50; B: J. Gardner 47-50, G. Smith 46-50; C: F. Sweeting 47-50, M. Kosovich 44-50. 50T Skeet: A: A. Yozzi 49-50, M. Weston 48-50; B: J. Rossi 48-50, R. Howell 44-50; C: T. Morony 48-50, J. Skoda 43-50.



**ALEXANDRA 13-6-88** — No wind, but wet (18). 25T Clayton Duck Hunters Skeet C'ship: OA & A: P. Johncock 25-25; B: I. Campbell 24-25; C: L. Schubert 26-29, K. Polst 23-27. 15T Comp CD 10T PS 5T SB: A: P. Johncock 34-35, I. Campbell 31-35; B: K. Polst 35-35, K. Hobbs 34-35; C: W. Phillips 32-35, J. Laxton 31-35. 25T President's DB C'ship: OA: L. Schubert 24-25; A: A. Famiglietti 79-81, I. Campbell 78-81; B: L. Schubert 24-25, R. Cribb 23-25; C: J. Laxton 22-25, J. Fleetwood 31-35. 25T Alexandra Members DB C'ship: OA: P. Johncock 51-51; A: P. Johncock 51-51, I. Campbell 42-43; B: R. Cribb 50-51, S. Stagbouer 31-32; C: W. Phillips 24-26, T. Phillips 23-26.

**BARMERA 5-6-88** — Cold & windy (15). 10T EO: R. Spencer 10-10, C. Nunn, H. Nunn, R. Maywald 9-10. 25T Hop: 1st B. Wilksch 23-26, 2nd D. Freundt 22-26, 3rd H. Nunn 27-31. Club DD C'ship: 1st R. Robertson & H. Nunn 18-20, 2nd R. Spencer & D. Freundt 17-20. Club Skeet C'ship: A: D. Freundt 22-25; B: I. Maywald 31-34; C & OA: B. Wilksch, Delrosa HG: 53-60.

**BORDERTOWN 22-5-88** — Perfect (27). 25T E.H. & B.M. Davis C'ship: OA & A: B. Wagg 50-50, T. Megaw 49-50; B: G. Warner 24-25, C. Copping 30-32; C: D. Crane 22-25, S. Zadow 26-30. 40T Club Mixed Target C'ship (Sponsor Mobil Oil): OA & A: B. Andrews 92-95, B. Growden 88-95; B: K. Howe 163-180, B. England 161-180; C: G. Dinning 48-60, K. Richards 45-60.

**INTERNATIONAL 19-6-88** — Fine & warm (72). 25T S.A. Sportsgoods Skeet C'ship: OA & B: D. Burton 87-87, B. Johnson 60-61; A: R. Dower 86-87, T. O'Connor 38-39; C: P. Munting 27-29, M. Martini 25-27. 25T Gawler River Trench C'ship: OA & B: B. Johnson 23-25, R. Mules 30-35; A: D. Stefanato 22-25, P. Marcoianni 31-35; C: A. Spera 22-25, P. Hall 28-35. 25T Gawler River PS C'ship: OA & A: L. Martin 75-75, P. Marcoianni 83-85; B: K. Hobbs 74-75, R. Mules 70-75; C: P. Libri 69-75, H. Stefanopoulos 68-75. Ladies: B. Wallace 66-75. 25T Peter & Camilla Marcoianni Shield DB C'ship: OA & AA: D. Olivero 36-36, D. Stefanato 30-31; A: D. Sparnon 25-25, A. Smith; B: B. Wallace 31-32, S. Stagbouer 30-32; C: A. Spera 25-25, R. Winckel 23-25. Ladies: Mary Martini 21-25. Winning Team S.A.G.C. No. 1, T. Kenyon, P. Casey, B. Cotel, B. Wallace, R. Winckel 119-125. HG: B. Johnson 142-150.

**KANGAROO ISLAND 29-5-88** — Excellent (16). 100T Smith Family "Mixed" 25T DB, 25T PS, 25T SB, 25T Hop: 25T DB: 1st P. Hendy 24-26, 2nd T. Booker 23-26; 25T PS: 1st P. Hendy 69-75, E. Smith, T. Booker 61-75; 25T SB: 1st S. Turner 24-25, 2nd T. Booker 21-25; 25T Hop: 1st S. Turner 25-25, 2nd T. Booker 24-25; OA: P. Hendy 134; r/up: S. Turner 130.

**KANGAROO ISLAND 28-6-88** — Gale force winds (14). 25T PS 15m: OA & B: P. Hendy 74-75, W. Reilly 68-75; C: W. Phillips 63-75, N. Litster 60-75. 30T DB C'ship: B: P. Hendy 27-30, K. Perry 26-30; OA & C: W. Phillips 29-30, M. Whelan 26-30. 10PR DR 15m: B: K. Perry 16-20, P. Hendy 13-20; C: N. Litster 13-20, M. Whelan 11-20.

**LAKE ALBERT 5-6-88** — Cold & windy (20). 25T Lake View Cake C'ship Cont: A & OA: P. Johncock 27-29, P. O'Connell 26-29; B: C. Brammer 22-25, L. Schubert 25-29; C: R. Craig 22-25, A. Williams 19-25. 25T Hop CD Metreage: 21-25m: P. Johncock 19-25, D. Beelitz 18-25; 16-20m: S. Appelkamp 23-25, N. Johncock, L. Schubert 22-25; 11-15m: Scott Craig, S. Ayres 20-25. 15T DB CD: A: N. Johncock 15-15, G. Michell 14-15, P. O'Connell 13-15; B: K. Strother, L. Schubert 13-15, Shane Craig 12-15; C: R. Craig 13-15, A. Williams 12-15, M. Videon 11-15. HG: P. O'Connell 48-54. Ladies HG: S. Appelkamp 44-50.

**MALLALA 12-6-88** — Windy & cool. 25T Lyn & Peter Munting Team & Graded Shoot: International: P. Marcoianni, G. Zappa, J. Richichi, M. Martini, P. Hall 115-125; OA & B: B. Wallace 25-25; A: B. Johnson 66-67; C: J. Algar 24-25. 10T Sweeps Cont: A: T. Kenyon 30-30; B: R. Fleming 30-30; C: H. Osley 27-20. HG donated by B. & B. Zawker; Metro Martini 69-71.

**MILLICENT 29-5-88** — Overcast (22). 20T SB C'ship: B & OA: S. Henderson

19-20, G. Height 17-20; A: J. Fartch 17-20, V. Beyer, R. Schleter 16-20; C: W. Hancock 15-20, J. Algar 14-20. 20T Mt Muirhead PS C'ship: A & OA: J. Fartch 60-60, I. Hetherington 56-60; B: S. Henderson 59-60, G. Height 54-60; C: J. Algar 57-60, D. Higgins 52-60. 20T DB CD: A: V. Beyer, I. Hetherington, S. Hetherington, R.R. Hammat, all 20-20; B: I. McArthur 20-20; C: J. Algar 19-20.

**MILLICENT 28-6-88** — Dull (10). 15PR DR C'ship: B & OA: G. Height 33-40, C. Copping 21-30; C: A. Morrison 22-30, D. Beyer 19-30; A: J. Fartch 31-40, R.R. Hammat 30-40. 20T DB C'ship: A & OA: V. Beyer 40-40; B: G. Height 39-40; C: A. Morrison 19-20. 20T Hop: 1st D. Higgins 20-20, 2nd J. Fartch 21-22, 3rd A. Morrison 20-22.

**MT GAMBIER 11-6-88** — Overcast, no rain (44). 25T SB C'ship: OA & A: L. Martin 27-28, J. Fartch 26-28; B: Gary Hayden 23-25, E. Chaplin 22-28; C: Glen Hayden 18-26, C. Glynn 17-26. 25T District DB C'ship: OA & A: I. Hetherington 42-42, R. Hammat 41-42; B: L. Sims 24-25, A. Vikins 26-28; C: P. Pettit 19-25, P. Hennessy 18-25. 25T DB Cont C'ship: OA & A: T. Megaw 30-30, T. Reschke 29-30; B: E. Chaplin 41-42, L. Sims 40-42; C: Glen Hayden 23-25, P. Pettit 21-25. 5T Ladies Event: 1st Monica Henderson 6-7, 2nd Alexis Hamilton 5-7, 3rd Pat Green 4-6, most unlucky Lorraine Wombwell. 25T Club Night DB C'ship: OA & A: T. Megaw 24-26, P. Green 23-26; B: Gary Hayden 22-25, G. Wombwell 27-34; C: Glen Hayden 17-25, P. Pettit 16-25. Morrison Motors Open HG: L. Martin 95-100.

**NOARLUNGA CITY 5-6-88** — Wet & windy (59). 20T DB CD: A: L. Martin, J. Richichi, R. Dean, R. Smith, H. Wallace all 18-20; B: P. Hall 20-20, G. Zappia, B. Newell 19-20; C: P. D'Alesandro, M. Bruno 18-20. 25T Trevor & Jane Penny DB C'ship: A: J. Richichi 25-25, R. Smith 24-25; B: K. Hobbs 25-25, F. Lupoi

## BARMERA GUN CLUB INC. S.A.

### 30th ANNIVERSARY SHOOT SATURDAY & SUNDAY

SEPTEMBER 3 & 4

150 Targets Skeet  
150 Targets D.T.L.

Full details Sept. C.T.S.N.

President: P. Caddy

## ALEXANDRA GUN CLUB S.A. Inc.

"On the Lake at Milang"

### 35th BIRTHDAY 2-DAY SHOOT

SATURDAY SEPTEMBER 17th

EVENT 1 — 25 Target Bill Quinn Skeet Championship

EVENT 2 — 25 Target Aus. Fire Services P/S

EVENT 3 — 25 Target I. & P. Campbell D/B Shield

EVENT 4 — 25 Target Clarkes Shoes P/S

EVENT 5 — Commonwealth Night Mixed Targets

SUNDAY SEPTEMBER 18th

EVENT 6 — 25 Target Clay Target P/S Championship

EVENT 7 — 25 Target Woodrow Shield D/B with

\$200 cash 1st; \$50 cash 2nd.

AA.A.B.C. plus team medals

EVENT 8 — 25 Target Sportsgoods S/B Championship

Saturday night traditional tea

For full details see C.T.S.N. Sept. edition

President: J. Fleetwood, 223 6544 B.H.

**IT'S ON AGAIN**

**GOOD TROPHIES**

**31 SASHES**

# **BROKEN HILL GUN CLUB SILVER CITY CHAMPIONSHIPS**

**SEPTEMBER 10 & 11, 1988**

**Saturday 8.30am**

**EVENT 1 Nom. \$15.00 O/S \$1.50  
SILVER CITY HANDICAP**

20 Target 3 groups 11-15, 16-20, 21-25m  
1st — Rifle & Sash; 2nd — Trophy all groups. Lady,  
Veteran & Juniors

**EVENT 2 Nom. \$30.00 O/S \$1.50  
SILVER CITY GIFT**

25 Target 15m Graded AA.A.B.C.  
1st each grade — Colour TV & Sash; 2nd & 3rd  
Trophies each grade. Lady, Veteran & Junior  
trophy.

*McKean Shield shot in conjunction*

**EVENT 3 Nom. \$9.50 O/S \$1.50  
SILVER CITY D/B CHAMPIONSHIP**

25 Target 15m Graded AA.A.B.C. Overall Trophy &  
Sash. 1st each grade trophy & sash; 2nd trophy all  
grades. Lady, Veteran & Junior trophy

**EVENT 4  
SOUTH AUST. STATE NIGHT MIXED  
TARGET CHAMPIONSHIP**

50 Target 15m Graded AA.A.B.C. Overall trophy &  
sash. 1st all grades trophy & sash; 2nd trophy all  
grades. Lady, Veteran & Junior trophies. 3 traps  
under lights.

*\*This event not in the High Gun*

**Sunday 8.30am**

**EVENT 5 Nom. \$9.50 O/S \$1.50  
WEST END P/S CHAMPIONSHIP**

25 Target 15m AA.A.B.C. Overall Trophy & Sash.  
1st each grade trophy & sash. 2nd all grades. Lady,  
Veterans & Juniors.

*Kindly sponsored by SOUTH AUSTRALIAN  
BREWERY*

**EVENT 6 Nom. \$30.00 O/S \$1.50  
BROKEN HILL GIFT**

25 Target 15m Graded AA.A.B.C. 1st each grade  
Microwave & Sash; 2nd & 3rd trophies each grade.  
Lady, Veteran & Junior trophy.

*Centenary Shield shot in conjunction*

**EVENT 7 Nom. \$9.50 O/S \$1.50  
SILVER CITY S/B CHAMPIONSHIP**

25 Target 15m Graded AA.A.B.C. Overall Trophy &  
Sash. 1st each grade trophy & sash. 2nd all grades.  
Lady, Veteran, Junior.

**SILVER CITY GUNS & AMMO HIGH GUN EVENTS  
1.2.3.5.6.7**

**Lady High Gun, Junior High Gun, Veterans High  
Gun**

Tea available Democratic Club Friday night 6-8pm — Ladies & Juniors ½ noms all events — Veterans  
half noms events 1.3.4.5.7 — All sweeps 50c 1st 12, 50c 2nd 13, 50c overall  
Practice from 3pm Friday 9th — All meals and cartridges available on grounds

*For accommodation, phone Sandy (080) 88 1903 or Hilltop Motor Inn (080) 88 7005 — Silver Haven  
Motel (080) 88 2218 — Tollfree Flag Motels (008) 33 5005*

*For car service, Shell Memorial Service Station, cnr William & Bromide Sts — Good Service — Auto  
Gas*

President: D. Johnston  
564 Wyman St, Broken Hill 2880

Secretary: S. Johnston  
564 Wyman St, Broken Hill 2880  
(080) 88 1903



# SOUTH AUSTRALIAN GUN CLUB

## ANNIVERSARY SHOOT

August 27 & 28, 1988

### SATURDAY 10am

- Event 1. **50 tgt The Gun Rack Enfield Skeet C'ship**  
Incorporating Joe Richards Memorial Teams Shoot  
A, B, C. 1, 2. Sash O/A.
- Event 2. **25 tgt A.B. Distributors Anniversary Trench C'ship**  
A, B, C. 1, 2. Sash O/A.
- Event 3. **20 tgt Peter Quire Anniversary Handicap**  
1, 2, 3, 4.
- Event 4. **20 tgt Hugh & Barb Wallace Anniversary Point Score Tower C'ship**  
A, B, C. 1, 2. Sash O/A.
- Event 5. **30 tgt Rob & Pam Fleming D/B C'ship**  
A, B, C. 1, 2, 3. Sash O/A.

### SATURDAY NIGHT 7.30pm

*Anniversary Dinner/Games Night in Clubrooms. Magnificent.  
Book early to avoid disappointment.*

### SUNDAY 10am

- Event 6. **25 tgt Peter Lehmann Wines Skeet C'ship**  
A, B, C. 1, 2. Sash O/A.
- Event 7. **20 tgt Reg Franks Anniversary Handicap**  
1, 2, 3, 4.
- Event 8. **25 tgt Colin Jacobs Anniversary Point Score C'ship**  
A, B, C. 1, 2. Sash O/A.
- Event 9. **50 tgt Olimpyc Targets Anniversary D/B C'ship**  
AA, A, B, C. 1, 2. Sash O/A.

*Overall High Gun sponsored by Terry & Linda Kenyon.  
All Target D.T.L. Jackpot min. \$150.*

*Free BBQ Sunday night after presentations.  
Ladies, Juniors, Veterans (60) reduced noms. on all events.*

*The Club sincerely thanks all sponsors for their invaluable support.*

The Gun Rack Enfield, A.B. Distributors, Peter Quire, Hugh & Barb Wallace, Rob & Pam Fleming, Reg Franks, Peter Lehmann Wines, Colin Jacobs, Olimpyc Targets and Scorpio Cartridges.

President: Hugh Wallace  
Phone 298 3961

Secretary: Terry Kenyon  
Phone 258 3646

**On-site Camping, Power, Hot Shower.**

# THE CEDUNA COMMUNITY HOTEL-MOTEL

*proudly sponsor*

## S.A. STATE BALL TRAP CHAMPIONSHIP

at the FAR WEST GUN CLUB,  
CEDUNA

**Saturday & Sunday,  
September 10 & 11**

**Saturday 10 at 11am**

**EVENT 1 — 50 Target Ball Trap State  
Championship**

**EVENT 2 — 50 Target D.T.L. AA-0, A-1, B-3,  
C-5**

**Sunday 11 at 10am**

**EVENT 1 — 10 Target EO Webber Kettle  
Sponsored by Pobke Machinery**

**EVENT 2 — 50 Target D/B  
Sponsored by J. & V. Holder**

**EVENT 3 — 50 Target D/B  
Sponsored by Shell Rd House**

**K. Parker Memorial High Gun  
over 2 days**

**Sponsored by F. & V. Parker**

**Meals, ammo etc. available on ground**

31-33; C. W. Newell 24-29, W. Phillips 23-29; Ladies: B. Wallace 19-25. 25T Phillips Family FS C'ship: A. J. Richichi 86-90, D. Norwood 83-90; B. G. Zappia 68-75, P. Hendy 67-75; C. J. Fleetwood 65-81, W. Phillips 62-81; Ladies: B. Wallace 61-75. 25T Bob Jane T-Mart South Plympton SB C'ship: A. H. Wallace 21-25, L. Martin 21-25; B. R. Cribb 22-25, K. Hobbs 21-25; C. W. Phillips 19-25, M. Whelan 19-24; Ladies: W. Newell 16-25. John Stewart Reilly Memorial HG: J. Richichi 131-145. Ladies HG: W. Newell 106-145. Veterans HG: R. Cribb 111-145. Many thanks to all trophy donors for our 8th birthday shoot which was successful despite the weather.

**PORT LINCOLN 11-6-88 & 12-8-88 — Fine, cool, slight wind (11).** 100T Skeet: A & OA: R. Pitt 97-100, G. Docking 92-100; B: P. Beale 94-100, T. Stratford 85-100, I. McCallum 84-100; C: J. Averis 90-103, M. Smith 86-105, B. Pobke 82-100. 5T EO: 1st D. Lymn, 2nd P. Beale, 3rd K. Firth. 100T DB: A & OA: G. Docking 99-100, D. Lymn 98-100, G. Lymn 94-100; B: J. Beale (Jnr) 98-100, B. Pobke 97-100, P. Beale 95-100; C: W. Lymn (Jnr) 89-100.

**S.A.C.T.A. 28-5-88 & 29-5-88 — Cool (30).** 50T City of Adelaide Skeet C'ship: A & OA: K. Holmes 50-50, R. Kimber 48-50; AA: R. Dower 48-50, D. Cunningham 47-50; B: P. Beale 49-50, G. Moore 47-50; C: W. Fisher 46-50, B. Pobke 45-50; Lady: B. Dower 47-50; Veteran: C. Copping 44-50. 50T Festival City Skeet C'ship: A & OA: D. Murphy 56-58, D. Sparnon 53-55; AA: R. Dower 49-50, D. Cunningham 47-50; B: A. Norman 49-50, T. Keane 48-50; C: A. Smith 48-61, W. May 47-50; Lady: B. Dower 43-50; Veteran: C. Copping 50-56. 50T S.A. Skeet C'ship: AA & OA: D. Cunningham 110-110, R. Dower 48-50; A: K. Holmes 86-87, A. Blease 59-60; B: G. Moore 50-50, D. Burton 49-50; C: A. Smith 47-50, L. Hancock 51-58; Lady: B. Dower 47-50; Veteran: P. Caddy 44-50. 25T Skeet Doubles C'ship: AA & OA: D. Cunningham 25-25, R. Kimber 24-25; A: A. Blease 24-25, T. O'Connor 23-25; B: A. Norman 29-31, G. Michell 28-31; C: A. Vilkins 22-25, B. Clogg 20-25; Lady: S. Applekamp 22-29; Veteran: P. Caddy 21-25. Postal Team: D. Sparnon, R. Dower, R. Kimber, A. Smith, D. Burton, K. Holmes, G. Yoannidis, P. Green, G. Michell, D. Murphy, L. Charles, B. Murphy, T. Keane, R. Dwyer, A. Norman. HG: D. Dower 87-87. Winning Zone Team: Central Zone: R. Dower, D. Sparnon, B. Murphy, R. Kimber, T. Keane 124-125. Ladies Postal Team: B. Dower, S. Applekamp, R. Michell, J. Curtis, B. Wallace. HG: B. Dower 23-25. Carnival OA: K. Holmes 185-191, 2nd D. Cunningham 184-191; Lady: B. Dower 147-175; Veteran: P. Caddy 150-175.

**S.A.G.C. 13-6-88 — Cold & windy (59).** 50T Iey Skeet Teams C'ship: OA & B: T. Kenyon 49-50, A. Smith 54-58; A: R. Dean 46-50, T. O'Connor 42-50; C: J. Richichi 46-50, B. Greenshields 42-50; winning team S.A.G.C. No. 1 226-250. 25T Trench PS: A: P. Marcionni 65-75, D. Olivero 63-75; B: J. Richichi 67-75, F. Atkinson 44-75; C: E. Commons 63-75, R. Fleming 51-75. 50T Continental: A: L. Martin 50-50, D. Oliver 48-50; B: W. James 46-50, G. Donald 44-50; C: R. Winckel 45-50, B. Harding 39-50. 25T President's DB C'ship: OA & A: M. Martini 39-39, L. Martin 38-39; B: W. Renney 25-26, P. Munting 24-26; C: G. Glavach 23-25, R. Winckel 22-25; Ladies: B. Wallace; Encouragement Award: Michelle Kenyon. OA HG: T. Kenyon 141-150.

**S.A.G.C. 26-6-88 — Fine & mild (68).** 25T Skeet C'ship: OA & A: R. Kimber 25-25, T. O'Connor 25-25; B: T. Keane 25-25, J. Hamer 24-25; C: T. Jeffere 22-25, P. Munting 22-25. 25T Trench C'ship: OA & A: T. Kenyon 46-50, P. Marcionni 21-25; B: B. Johnson 43-50, S. Maynes 17-25; C: H. Wallace 31-45, B. Pobke 30-45. 20T PS Tower C'ship: OA & A: P. Marcionni, R. Dower; B: R. Winckel, D. Harris; C: J. Hamer, A. Smith. 20T Club Hop: 1st K. Prescott 21-21, 2nd G. Lymn 20-21, 3rd R. Winckel 19-20, 4th S. Baynes 19-20. 25T DB C'ship: OA & AA: T. Kenyon 64-64, D. Olivero 63-64; A: L. Martin 25-25, H. Wallace 24-25; B: R. Fleming 29-30, T. Galkowski 25-26; C: M. Renney 24-25, H. Stephanopolous 23-25. OA HG: T. Kenyon 146-155.

**SOUTHERN 19-6-88 — Fine & sunny, no wind (14).** Patron's DB C'ship Trophy 20T 15m: A: H.J. Chibnall 18-20, T.W. Morris 17-20; B & OA: B.C. Newell 20-20, R. Cribb 19-20; C: J.S. Gould 17-20, H.S. Laxton 16-20. Southern Districts SB C'ship 25T 15m: A: T. Morris 24-25, H.J. Chibnall 19-25; B: B.C. Newell 28-30, R. Hill 27-30; C: W. Harding 22-26, Mrs W. Newell 21-26. Hotel Victor HG: B.C. Newell 43-45.

**UNGARRA 19-6-88 — Sunny (9).** 25T Graded Skeet: A: R. Pitt 24-25; B: T. Stratford 24-25; C: J. Averis 24-25. 20T DB C'ship: A: R. Pitt 19-20; B: K. Firth 19-21 after shoot-off with T. Stratford; C: W. Simms 18-20; championship winner: R. Pitt. 25T SB C'ship: A: R. Pitt 24-25; B: K. Firth 22-25; C: J. Curtis 21-25; OA championship winner: R. Pitt. 20T Tower: 1st K. Firth, T. Stratford 19-20, 3rd J. Averis 18-20. OA HG: R. Pitt 43-45.

**WILKAWATT 28-5-88 & 29-5-88 — 100T Olympic Trap: AA: M.W. Fisher 82-100; A: C. Bentley 87-100; B: P. Green 84-100; C: P. Hall 83-100. 25T Olympic Trap: AA: B. Growden 69-85; A: P. Marcionni 65-75; B: P. Green 65-75; C: W. Renney 55-75. OA HG: C. Bentley 172-200; AA HG: G. Mark 162-200; A HG: F. Vella 167-200; B HG: P. Green 167-200; C HG: P. Hall 133-175. Postal Team: C. Bentley 23-25, P. Green 24-25, T. Kenyon 21-25, M.W. Fisher 18-25, P. Hall 18-25, M. Starr 20-25. Team HG: P. Green 24-25.**



**QUEENSLAND**

**BALLANDEAN (No date supplied) — 5T EO Pts 15m: L.J. Kennett, A.J. Smith, R. Cosmo 15-15; 25T DB 15m SS: B: R. Sonogo 24-25; C: P. Stabile 22-25, S. Sonogo 22-25; 25T FS 15m: B: R. Cosmo 67-75; C: L.J. Kennett 61-75. 25T DB Hop: 1st F. Musumeci 24-26 after shoot-off — L.J. Kennett 23-25, F. Musumeci 23-25, 2nd L.J. Kennett 23-26, 3rd R. Cosmo 22-25. HG: R. Cosmo 127-140. 11-14m C Grade HG: L.J. Kennett 119-140.**

**BLACKALL 23-6-88 — Fine & cool (33).** 20T DB Pts 15m: A: D. Casagrande; B: M. Doyle; C: R. Kennedy. Central Zone SB Cont C'ship 25T 15m: OA: A. Grimshaw; A: D. Burns; B: M. Doyle; C: P. Russell. 15T Mixed off 15m: 1st B. Richardson, 2nd D. Casagrande; 3rd A. McPherson. 25T DB off Hop: 1st A. Grimshaw, 2nd M. Doyle, 3rd A. Olsen. HG: B. Richardson. Inter HG: J. Webber. FM: T. Russell. Ladies: J. Garrod.

# WARWICK CLAY TARGET OPEN SHOOT

Saturday 3rd and Sunday 4th September, 1988

Commencing 1.30pm, SATURDAY 3rd

**EVENT 1** Nom. \$12.00

GRAHAM STEVENS WINDSCREENS  
— WINDSCREENS SPECIALISTS  
25 Target D/B Championship 15m.  
Badge & Trophy AA.A.B.C. Grades.  
Trophy second each grade

**EVENT 2** Nom. \$12.00

DEIGHTON MOTORS — GOLDEN  
WEST HOLDEN DEALERS —  
WARWICK

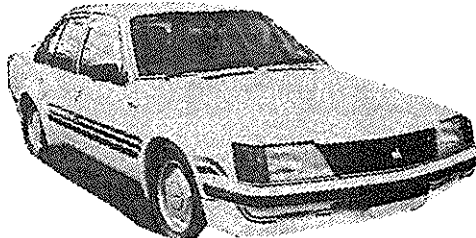

25 Target D/B Continental  
Championship 15m. Badge & Trophy  
AA.A.B.C. Grades. Trophy second  
each grade

**SATURDAY NIGHT BARBECUE TEA**  
(Free with total noms) followed by  
**CALCUTTA**

**SUNDAY 6th SEPTEMBER**  
Commencing 9am

**EVENT 3** Nom. \$12.00

COMMONWEALTH BANK —  
AUSTRALIA'S LEADING BANK  
25 Target D/B Pointscore  
Championship 15m. Badge & Trophy  
11-15, 16-18, 19-21, 22-25 meterage

**COMMONWEALTH  
BANK.**

Australia's leading bank.

*Veterans, Ladies and Juniors 60% of total noms on full programme — Plenty of room on grounds for camping. Power. No showers.*

*For accommodation please contact the following direct:*

McNeveins Gonyah Motel (076) 61 5588  
Warwick Motor Inn 61 2722  
Highlander Motel 61 2111  
Buckaroo Motel 61 3755  
President: Don Cameron  
(076) 61 4220

Centre Point Motel 61 3503  
Oasis Caravan Park 61 2876  
Warwick Caravan Park 61 3632

Secretary: Daphne Cameron  
P.O. Box 158, Warwick  
(076) 61 4220

groups. Trophy second each meterage group

**EVENT 4** Nom. \$24.00

50 TARGET COMBINED SPONSORS  
MAJOR TROPHY EVENT D/B 15m  
\$75 value trophy first each meterage  
group, donated by WARWICK  
OUTDOORS AND SPORTS — G.G.  
NEWY, Prop.

\$45 value trophy second each  
meterage group, donated by BARRY  
LYELL — CALTEX OILS.

\$35 value trophy third each meterage  
group, donated by VIC WIEDMAN —  
PATRON

Trophy Veteran, Lady, Junior  
\$75 trophy to the overall winner in  
addition to meterage, donated by DON  
CAMERON.

**CALCUTTA WILL BE RUN ON THIS  
EVENT**

**EVENT 5** Nom. \$20.00

THE WARWICK CLAY TARGET CLUB  
INC. \$600 CASH DIVIDE  
30 Target D/B 15m. \$150 each  
meterage group, divided 60, 30, 10.  
**HIGH GUNS:** 125 cartridges each  
grade donated by WINCHESTER  
AUSTRALIA.

Veteran, Lady and Junior High Guns  
donated by LARRY SMITH, plus best  
11-14 meterage shooter, trophy  
donated by RICHIE HAMILL.

Optional Sweeps \$1 on each 25  
Targets, hits to count, irrespective of  
grade on events 1, 2, 3 & 4

**Total Noms. \$80.00 plus Sweeps**

**BRISBANE 29-5-88** — 25T DB: AA: G. Redmond 46-46; A: R. Brook 29-31; B: A. Pearce 23-25; C: J. McCausland 23-25. 25T DB Pts Cash: AA: G. Redmond 75-75; A: C. Mariner 71-75; B: R. Pennisi 66-68; C: H. Fingel 68-75. 25T SB: AA: N. Gird 33-34; A: J. Gibson 24-25; B: D. Moffit 27-30; C: M. Crombie 22-25. 15PR DR Cash: AA: G. Redmond 25-30; A: A. Maguire 24-30; B: R. Horn 25-30. HG: G. Redmond 148-155.

**BRISBANE 15-6-88** — 25T DB Cash: A: C. Ennis 28-29; B: J. Burlison 24-25; C: C. McFarlane 24-25. 25T DB Pts Badge Event: A: A. Maguire 73-75; B: B. Sekaf 70-75; C: R. Tipler 63-75.

**BUNDABERG 5-6-88** — Fine & sunny (21). 25T Skeet Hop CD: I.L. Sergiacomi, A. Millman, K. Palmer, K. Rehbein, S. Plath, K. Greensill, all 23-25. 25T Skeet Hop: A: R. Rehbein; B: B. Harris; C: K. Greensill. 25T Trap DB Pts 15m SS: A: R. Rehbein 70-75; B: T. Petersen 67-75; C: A. Millman 69-75. 25T Hop: 11-15m: T. Harris 41-42; 16-19m: I.L. Sergiacomi 25-27; 20-25m: P. Shaw 22-26. 25T DB Cont C'ship: OA & A: P. Shaw; B: T. Petersen; C: F. Agius. 10PR DR 15m: A: P. Shaw 17-20; B: T. Petersen 16-20; C: S. Plath 13-20. FM HG: A. Millman 122-145. HG: R. Rehbein 129-145. Junior HG: T. Harris 109-145.

**CALLIDE DAWSON 15-5-88** — Fine (9). 20T DB Pts 15m: A: R. Mylrea, B. Ryan 51-60; B: J. McKenna, J. Ryan 53-60; C: M. Demasi 49-60. Callide Dawson DR C'ship: OA & B: J. Ryan 18-20; A: R. Mylrea 16-20; C: M. Demasi 15-20. 20T DB Hop: 1st K. Miller 20-20, 2nd M. Demasi 21-22, 3rd B. Ryan 20-22. HG: B. Ryan 90-100.

**CHARLEVILLE 25-6-88** — Gusty, cool (14). 25T Skeet: A. Denton 21-25, M. Denton 20-25. 25T DB 15m Badge: A. Scouler 24-25, B. King, A. Denton, M. Denton 22-25. 25T DB Pts Hop Mug: A. Scouler 65-75, N. Gadsby, B. King 64-75. 10PR DR 15m K. Lynam Trophy: J. Peckett 17-24, A. Scouler 16-24.

**CHARTERS TOWERS 5-6-88** — Fine (32). 25T Skeet: L. Frerichs, D. Killick, B. Gayton, E. Edwards, R. White, G. Woollam. 10T DB Hop: G. Archer, P. Killick, L. Frerichs, G. Fawcett, R. Hickmott, G. Woollam, D. Killick, 10-10. 10T 15m: P. Killick, A. Ford, W. White, R. Smithwick, G. Archer, 10-10. 25T DB Hop: J. Keith 25-25, A. Ford, G. Archer, N. Beale, L. Frerichs, R. Hickmott. 15T DB 15m: N. Beale, J. Keith, A. Ford, D. Killick, L. Frerichs, M. Hanna, R. Smithwick. 25T DB Graded: A: D. Killick; B: R. Hickmott; C: L. Frerichs.

**CLERMONT 22-5-88** — Perfect (20). 20T DB 15m CD: A: N. Deeley, B. Nasser, C. Ennis 20-20; B: J. Deeley, S. Sendonas 18-20, T. McDonald 15-20; C: J. Keith 19-20, P. Wilson 18-20, P. Henderson 17-20. 50T Sparrow Points (Trophy): OA : S. Sendonas 136-150 (shoot-off B. Nasser); A: B. Nasser 136-150; B: T. McDonald 130-150 (shoot-off J. Deeley); C: J. Keith 119-130. 50T DB 15m CD Mini Calcutta: A: C. Ennis 50-50, B. Nasser, J. Paull, J. Dobbins 48-50; B: J. Deeley 49-50, T. McDonald 46-50, S. Sendonas 42-50; C: P. Wilson 48-50, B. Windridge 48-50, A. Berne 45-50.

**CLONCURRY 5-6-88** — Fine & sunny (12). 20T DB ES Hop: R. Keyes 18, J. Yanko, T. Matthews 17, Rod Cusack, M. McGill, B. Power 15, Rob Cusack 14, B. Arsenic 12. 25T SB 15m: M. McGill 25, Rod Cusack, Rob Cusack 23, R. Keyes 21, B. Power, J. Yanko, T. Matthews 20, B. Arsenic 14. 25T DB Pts

C'ship 15m: Rod Cusack 74, T. Matthews 73, M. McGill 71, R. Keyes 70, B. Power 68, Rob Cusack 63, J. Yanko 61, B. Arsenic 54. 5PR DR: Ron Keyes, B. Power 8, Rod Cusack, T. Matthews 7, M. McGill, B. Arsenic 6, Rob Cusack 4, J. Yanko 3. OA HG: Rod Cusack 119-130.

**DALBY 22-5-88** — Fine (24). 20T DB 15m SS: A: W. Allan, R. Taylor 19-20; B: J. Fabian 20-20, M. Dennis, W. Sattler, J. Stone 19-20; C: N. Hounslow 19-20, G. Wenham 18-20, P. Bonser 17-20. Champion of Champions 15m 25T: A: R. Taylor 22-27; B: W. Sattler 31-33; C: N. Hounslow 23-25. 25T Hop: 1st L. Winten 24-25, 2nd P. Jones 23-25, 3rd J. Allan 31-34. OA HG: J. Fabian 65-70. Inter HG: N. Hounslow 62-70.

**DALBY 24-4-88** — Fine & light wind (16). 20T DB 15m SS: A: R. Taylor, K. Srb, W. Allan 18-20; B: R. Price, G. Weber, J. Stone 19-20; C: N. Hounslow 19-20, M. Bassingthwaite, G. Wenham 15-20. 16PR DD 20m: 1st R. Taylor & R. Price 13-17, 2nd L. Winten & G. Weber 13-18. 10PR DR 15m SS: A: W. Allan 15-20, R. Taylor 13-20, K. Srb 12-20; B: J. Stone 15-20, G. Bickerton 14-20, R. Price 12-20; C: N. Hounslow, G. Wenham 13-20, L. Winten, M. Bassingthwaite 12-20. 25T Hop: 1st O. Crothers 25-27, 2nd W. Allan 24-27, I. Chard 23-26. OA HG: W. Allan 45-49. Inter HG: N. Hounslow 40-45.

**DYSART 4-6-88** — Rainy, dull (38). 25T Broadsound Dist DB C'ship: OA: R. Maroske 70-70; AA: D. Casagrande 65-66; A: G. Whitfield 37-38; B: G. Chippendale 27-28; C: P. Fields 23-25. 25T Broadsound Dist FS C'ship: OA: R. Maroske 96-96; AA: D. Casagrande 74-75; A: B. Meaney 84-87; B: R. Schrock 93-96; C: S. Gough 64-75. 25T Broadsound Dist SB C'ship: OA: R. Maroske 25-25; AA: D. Casagrande 24-25; A: B. Hoppgood 25-25; B: J. Deeley 24-25; C: P. Henderson 23-25. 25T DB Silver Fox/Curley Trophy: AA: D. Casagrande 25-25; A: N. Deeley 25-25; B: R. Schrock 25-25; C: S. Gough 23-25.

**DYSART 5-6-88** — Fine & sunny (37). 25T Broadsound Dist Cont C'ship: OA: B. Hoppgood 29-29; AA: R. Maroske 23-25; A: G. Whitfield 23-29; B: J. Deeley 24-25; C: A. Berne 23-25. 50T DB Calcutta: AA: D. Casagrande 50-50, R. Maroske 49-50, A. Daly 43-50; A: N. Deeley 50-50, G. Cross 71-72, R. Meaney 70-72; B: T. Curtis 48-51, J. Deeley 53-57, P. Wilson 52-57; C: P. Henderson 47-50, A. Berne 46-50, P. Fields; Ladies: J. Meaney 42-50. 25T Hop: 1st J. Deeley 25-25, 2nd S. Gough 24-25, 3rd P. Fields 28-30. HG: R. Maroske. Ladies HG: I. Cross.

**GLADSTONE 26-6-88** — Cold & windy (13). 25T Skeet: A: J. Riggs 23-25; B: B. Honor 24-25; C: F. Agius 29-33. 25PR Skeet Doubles: A: J. Riggs 44-50; B: R. Hannah 47-50; C: F. Agius 43-50. 25T DB Pts: A: J. Riggs 70-75; B: B. Honor 65-75; C: F. Agius 49-75. 25T DB Hop: 1st K. Ross 21-25, 2nd I. Sergiacomi 20-27, 3rd B. Honor 26-34. 20PR DD 20m: 1st B. Van Der Schoot & B. Honor 14-20, 2nd J. Riggs & D. Augur 14-22. HG: B. Honor 83-100.

**GYMPIE 12-6-88** — Fine. 100T DB C'ship 15m: AA: L. Stolberg 91-101, G. Durre 89-100; A: B. Stolberg 91-101, D. Rowsell 89-100; B: C. Harrison 90-100, N. Dale 81-100, G. Foster 80-100; C: A. Harris 77-100, T. Harris 78-100, D. Gardner 74-100. OA: G. Goding 92-101.

**IPSWICH 5-6-88** — Fine & overcast (24). 25T Skeet Graded SS: A: D. Sigga, R. Porter, A. Long, N. Dimmick; B: P. Stein. 50T Skeet Green Swamp C'ship:

# GLADSTONE CLAY TARGET CLUB INC.

## WINTER CARNIVAL

Saturday August 27 — 6.30pm

Sunday August 28 — 9am

### NIGHT CHAMPIONSHIP

50 Target D/B 15m  
Sash O/A Badge & Trophy other three grades

Nom. **\$25.00**

### GRAND PRIX

100 Target D/B 15m  
Trophies & Sashes overall and first other three grades. Trophy 2 and 3 each grade

Nom. **\$35.00**

Optional Sweeps \$1 ea 25T

*Committee reserves the right to alter the program*

**AA Trophies if 5 or more shooters  
Vic Summers Shield Rockhampton /  
Gladstone Teams**

L. Dalton: 78 1380 — W. Scarborough: 72 5497 — D. Auger: 72 1696 — J. Riggs: 72 4796

# CAIRNS & DISTRICT CLAY TARGET GUN CLUB

P.O. Box 5054 M.S.O., Cairns 4870

## ANNUAL TWO DAY SHOOT

Commencing Friday, September 2. Practice, Nominations and Fellowship  
Competition starts 8.30am Saturday September 3

**EVENT 1** Nom. \$10.00 O/S \$2.00  
FAR NORTH QUEENSLAND D/B  
CHAMPIONSHIP

25T from 15 metres. Graded AA.A.B.C.  
Overall winner: Sash

**EVENT 2** Nom. \$10.00 O/S \$2.00  
F.G. SIMPSON MEMORIAL S/B  
CHAMPIONSHIP

25T from 15m, Graded AA.A.B.C.  
Overall winner: Badge

**EVENT 3** Nom. \$20.00 O/S \$4.00  
CAIRNS & DISTRICT  
"SHELL SHOOT"

50T D/B 15m Graded AA.A.B.C.

**EVENT 4** Nom. \$4.00 O/S \$2.00  
BRIAN BELL T.V. TEAM SHOOT  
10T P/S from 15m. Any 5 member team

*Saturday Night: Dinner & Social Hour,  
Calcutta Draw & Auction*

Competition resumes 8.30am Sunday,  
September 4

**EVENT 5** Nom. \$10.00 O/S \$2.00  
CAIRNS & DISTRICT P/S  
CHAMPIONSHIP

25T from 15m (Points) Graded  
AA.A.B.C. Overall winner: Sash

**EVENT 6** Nom. \$20.00 O/S \$4.00  
CAIRNS & DISTRICT CASH  
ANNUAL

50T D/B from 15m. Meterage prizes in  
addition to overall winners' prizes.  
Meterage prizes: 11-14m, 15-19m,  
20-25m. Best Lady shooter \$25;  
Best Junior shooter \$25.

**EVENT 7** Nom. \$10.00 O/S \$2.00  
CORAL COAST CONTINENTAL P/S  
CHAMPIONSHIP

25T from 15m, Graded A.B.C. Overall  
winner: Sash

*HIGH GUN EVENTS: 1,2,3,5,6,7 includes  
Ladies, Juniors & Veterans High Gun Events*

Early nominations greatly appreciated. Camping facilities on shooting ground located MAHER ROAD,  
NORTH GORDONVALE.

Committee reserves the right to alter programme

*Club wishes to thank all sponsors, and Underwood Hire, for their generous support.*

**PRESIDENT:** Nimmo Bruce  
Ph: 51 1879 B.H. 53 3515 A.H.

**SECRETARY:** Kathy Harrison  
Ph: 55 3558

*Accommodation bookings available on request*

# BRISBANE ANNUAL EXHIBITION



13th, 14th and 15th August

## SATURDAY 13th AUGUST

9.30am Start

- EVENT 1** **Nom. \$11.00**  
**CASTROL CLEANERS D/B CHAMPIONSHIP**  
 25 Targets 15m Graded AA.A.B.C. Sash and Trophy  
 Overall. Trophy remaining grades
- EVENT 2** **Nom. \$11.00**  
**WINCHESTER D/B POINTS CHAMPIONSHIP**  
 25 Targets 15m Graded AA.A.B.C. Sash & 500  
 Winchester cartridges Overall. Trophy remaining  
 grades. Sash & Trophy best Lady. Best Junior  
 sponsored by Winchester.
- EVENT 3** **Nom. \$11.00**  
**STEVENS & SONS S/B CHAMPIONSHIP**  
 25 Targets 25m Graded AA.A.B.C. Sash & Trophy  
 Overall. Trophy remaining grades
- EVENT 4** **Nom. \$11.00**  
**EXHIBITION HANDICAP**  
 Bauman Trophy. 25 Target. Trophy 1, 2, 3



## SUNDAY 14th AUGUST

9.30am Start

- EVENT 5**  
**GOODYEAR TYRES**  
 25 Targets 15m Graded AA.A.B.C. Sash & Trophy  
 Overall. Trophy remaining grades
- EVENT 6**  
**BRISBANE EXHIBITION**  
 30 Targets 15m Graded AA.A.B.C. Sash & Trophy  
 Overall. Trophy remaining grades
- EVENT 7**  
**MEADOWS TRAMPOLINE**  
 15 Targets D/B Points 15m Graded AA.A.B.C. Automata  
 remaining grades. Best of 3

Juniors, Ladies, Veterans 70% Normal  
 Carlton & United Brewery & M. Hawkshaw  
 Campbell Brodrick & Co. Junior High  
 Veterans High Gun sponsor  
 The committee reserves the right to  
**Sweep to be held on Event 7 & 8**  
**Barbecue Saturday**  
**President: Tom Meagher**  
**Vice President: John Tipler**  
**Club: Ross Tipler**

# GUN CLUB

# TION CARNIVAL

nd 17th August

th AUGUST

Start  
Nom. \$12.00  
D/B CHAMPIONSHIP  
A.A.B.C. Sash & Trophy  
remaining grades  
Nom. \$15.00  
POINTS CHAMPIONSHIP  
A.A.B.C. Sash & Trophy  
remaining grades  
Nom. \$15.00  
SPORT MEDLEY  
m; 15 Targets Handicap;  
ic shotgun Overall. Trophy  
st Lady, best Junior

## — SPORTING CLAYS —

### EXHIBITION WEDNESDAY 17th AUGUST

9.00am Start

**EVENT 1** Nom. \$12.00  
VALLEY CUT PRICE CIGARETTES CHAMPIONSHIP  
50 Targets Graded A.B.C. Trophy & Medallion 1st  
each grade. Trophy 2nd each grade

**EVENT 2** Nom. \$15.00  
VALLEY CUT PRICE CIGARETTES \$600 CASH  
EVENT  
50 Targets Graded A.B.C. \$100 1st each grade; \$60  
2nd each grade; \$40 3rd each grade  
\$1.00 graded sweep on each event  
\$1.00 graded sweep on the 100  
**SPORTING CLAYS**

inations if whole programme shot  
w Cup & Trophy for Overall High Gun  
Ladies High Gun  
h Gun  
ed by H. & J. BRASHER  
right to alter programme  
nd will be drawn on Sunday  
y night at Club  
ows (07) 286 2607  
orter (07) 398 4257  
(07) 398 4555

# KINGAROY GUN CLUB INC.

## ONE DAY SHOOT

SUNDAY AUGUST 7 — 9.00am start

- Event 1 25T D.B. 15m Taabinga C'ship \$8.00  
Badge OA, Trophy A.B.C.
- Event 2 60T Medley \$20.00  
(20T DB 15m, 20T SB 15m, 20T Pts 15m)  
Trophy A.B.C.
- Event 3 25T D.B. 15m Taabinga Cont C'ship \$8.00  
Badge OA, Trophy A.B.C.
- Event 4 25T D.B. H'cap Cash Divide \$10.00  
(50% Nom. back to shooters 60/30/10)

**Barbecue Lunch**

President:  
P. McDonald  
(071) 62 1682

Secretary:  
G. Bickerton  
(071) 64 4141

# TOWNSVILLE GUN CLUB

## ANNUAL SHOOT

20th-21st AUGUST, 1988  
SATURDAY 20th — 9.00a.m.

- EVENT 1 Townsville Skeet Championship  
50 Target Skeet
- EVENT 2 25 Target D/B Trophy - 15m  
Graded
- EVENT 3 Townsville S/B Championship  
25 Target Graded  
**BARBECUE TEA**
- EVENT 4 Nth. Qld. Night Mixed Target Championship  
10 D/B, 10 S/B, 10 Pts, 5 Pr D/R Graded

SUNDAY 21st — 9.00am

- EVENT 5 Townsville D/B Championship  
50 Target Graded
- EVENT 6 Townsville Pts Championship  
25 Target Graded
- EVENT 7 Cash Handicap  
25 Target D/B Meterage Groups  
Camping available on the grounds

President:  
Tom Comerford  
(077) 73 2815

Secretary:  
Daphne Leeds  
(077) 79 3149

Club Phone  
(077) 78 8163

# BUNDABERG GUN CLUB

Incorporated

Hinkler Airport Bundaberg

## ANNUAL TWO DAY SHOOT

3rd & 4th September

Saturday 3rd — 1pm Start

- EVENT 1 25 Target D/B 15m A.B.C. Sweepstakes Nom. \$7.00
- EVENT 2 25 Target D/B 15m Trophies 1st & 2nd each meterage  
11-14, 15-17, 18-20, 21-25 Nom. \$18.00 O/S \$2.00
- EVENT 3 25 Target D/B Points 15m Championship  
Badge Overall, Trophies AA.A.B.C. Nom. \$12.00 O/S \$2.00

*Evening meal on grounds*

Sunday 4th — 9am Start

- EVENT 4 20 Target S/B 15m A.B.C. Sweepstakes Nom. \$6.00
- EVENT 5 25 Target D/B 15m Trophies 1st & 2nd  
AA.A.B.C. Nom. \$12.00 O/S \$2.00
- EVENT 6 25 Target D/B Cash Handicap  
\$100 1st, \$25 2nd in Meterage. 11-14, 15-17,  
18-20, 21-25  
Bundy Rum Teams Event shot in conjunction  
with 5 and 6 Nom. \$18.00
- EVENT 7 15 Pair Double Rise 15m Trophies AA.A.B.C. Nom. \$10.00

*Overall High Gun — 11-15m High Gun —  
Junior and Ladies C Grade 60% of total  
nomination on whole programme — All opt.  
sweepstakes on 25 Targets — Total  
Nominations \$83.00, optional sweepstakes  
(events 2,3,5) \$6.00*

The Committee reserves the right to alter, postpone or cancel any  
or all of this programme.

President: Gino Sergiacomi — phone 79 9203  
Secretary: Noel Muller — phone 72 0722  
Treasurer: Graham Plath — phone 79 8257



# DALBY GUN CLUB INC.

Affiliated A.C.T.A.

**ENDORSED BICENTENNIAL ANNUAL SHOOT**



An  
Endorsed  
Bicentennial  
Activity

**Saturday 27 August and Sunday 28th August, 1988**

**SATURDAY 27 AUGUST**

**12 NOON START**

- EVENT 1** 10 TARGET DOUBLE BARREL EYE OPENER S/Stakes 15m **Nom. \$4.00**
- EVENT 2** DALBY & DISTRICT BICENTENNIAL DOUBLE BARREL CHAMPIONSHIP 25 Target 15m Badge O/A  
Trophy AA.A.B.C. 1st & 2nd Best C11  
DONATED BY PIONEER SEEDS **Nom. \$10.00 O/S \$1.00**
- EVENT 3** \$550 MEDLEY 30 Targets 15m  
15 Targets Continental — 15 Targets Double Barrel  
Graded AA.A.B.C. \$125 each Grade, \$50 O/A. Cash Divide 60%, 30%, 10% **Nom. \$15.00**

**SUNDAY 28 AUGUST**

**9am START**

- EVENT 4** DALBY & DISTRICT BICENTENNIAL POINTS CHAMPIONSHIP 25 Targets 15m Badge O/A  
Trophy AA.A.B.C. 1st & 2nd Best C11  
DONATED BY STEWARTS FARM SUPPLIES **Nom. \$10.00 O/S \$1.00**
- EVENT 5** \$1,100 CASH EVENT "CALCUTTA" 50 Targets  
25 Targets Double Barrel, 25 Targets Handicap 15m \$100 O/A  
\$250 each Division. Cash Divide 60%, 30%, 10%  
Four Divisions: 11-15, 16-19, 20-22, 23-25 **Nom. \$30.00**
- EVENT 6** PRESIDENT'S TROPHY 30 Targets Double Barrel Continental 15m Graded AA.A.B.C. 1st & 2nd  
Trophy each grade **Nom. \$12.00**

★ ★ ★

*The Fred Flegler Memorial Shield will be shot in conjunction with Event 5. Teams of 5 Shooters  
(Club Team)*

OVERALL HIGH GUN DONATED BY WINCHESTER — FRONT MARKER TROPHY  
LADIES & VETERANS HIGH GUN TROPHIES  
TOTAL NOMINATIONS: \$81.00 O/S: \$2.00  
LADIES & JUNIORS — 60% Nominations

★ ★ ★

**CALCUTTA & BARBECUE ON GROUNDS SATURDAY NIGHT**

The Committee reserves the right to alter or modify the programme if necessary

**ACCOMMODATION AVAILABLE AT:**

Dalby Motel: (074) 62 3222; Gallery Motel: (074) 62 2300; Myall Motel: (074)  
62 3399; Dalby Manor Motel Inn: (074) 62 1011; Windsor Motel: (074) 62 2944;  
Russell Hotel: (074) 62 2122; Pathfinder Motor Inn: (074) 62 4433.

REFRESHMENTS & CARTRIDGES ON GROUNDS

President: Mr Rob Taylor  
MACALISTER Ph. (074) 63 5142

Secretary: Mr Gordon Wenham  
9 Ayrton St, Dalby  
Ph: (074) 62 2996

A & OA: D. Siggs 50-50; B: F. Grey 46-50; C: V. McInnes 44-50. 50T DB Colour City C'ship: OA & A: J. Kennedy 50-50; AA: W. Stevens 49-50; B: B. Payne 42-50; C: J. Herman 41-50. 25T DB Pts Club C'ship: OA & AA: W. Stevens 75-75; A: G. Mariner 69-75; B: B. Payne 67-75; C: B. Mundt 70-75. HG: W. Stevens.

**KALLANGUR 4-6-88** — Very wet (33). 25T DB Trophy Event: OA: A. Maguire 43-43; AA: K. Nasarenko 42-43, E. Chizzoni 22-25; A: B. Pritchard 25-26, G. Burlison 28-29; B: M.A. Donaldson 37-38, R. Samson 24-25; C: J. Farrow 24-25, T. Nasarenko 23-25. 25T DB Hop Trophy: 1st M.A. Donaldson 32-33, 2nd G. Willett 31-33, 3rd N. Bowden 28-29, 4th J. Box 26-27, 5th B. Pritchard 24-25. 25T DB C'ship: OA: S. Steenstrup 25-25; AA: E. Chizzotti 24-25, K. Nasarenko 23-25; A: J. Box 31-32, K. Munday 30-31; B: M.A. Donaldson 28-29, R. Samson 27-28; C: G. Willett 24-25, M. Gripske 23-24.

**KALLANGUR 5-6-88** — Cloudy & fine (38). 25T Pts Cont S.E. Zone C'ship: OA: J. Box 72-75; AA: E. Chizzotti 71-84, 2nd K. Nasarenko 70-84; A: J. Box 72-75, W. Daniells 68-75; B: R. Samson 67-75, J. Burlison 66-75; C: G. Willett 64-75, V. Greenberg 69-84. 30T DB Bicentennial C'ship: AA: K. Nasarenko 28-30, E. Chizzotti 27-28; A: K. Munday 30-30, W. Nioa 54-55; B: R. Samson 36-37, J. Burlison 41-43; C: A. Adams 33-35, G. Willett 32-35; Lady: T. Nasarenko 23-30; Veteran: C. Selke 27-30, G. Willett 28-30. 30T Trophy 15T Pts. 15T DB: OA: J. Tainsh 60-60; AA: E. Chizzotti 93-98, K. Nasarenko 90-98; A: G. Goding 67-68, G. Burlison 64-68; B: R. Samson 57-60, M. Donaldson 56-60; C: G. Willett 53-60, T. Nasarenko 50-60; Lady: T. Nasarenko 50-60; Veteran: G. Tainsh 60-60; Junior: G. Willett 53-60. 25T SB Trophy: OA: J. Tainsh 26-28, AA: K. Nasarenko 23-25, E. Chizzotti 22-25; A: S. Steenstrup 25-28, J. Box 24-26; B: N. Green 29-32, R. Samson 28-32; C: A. Adams 23-25, C. McFarlane 22-25. HG: AA: E. Chizzotti, K. Nasarenko 233; A: J. Box 252; B: R. Samson 243; C: G. Willett 233; Junior: 1st G. Willett 233, 2nd J. Clem 179, 3rd B. Bowden 174. Team against Brisbane, won by Kallangur 505, Brisbane 433. W. Daniells, K. Munday, E. Chizzotti, K. Nasarenko, G. Burlison, G. Willett.

**NORMANTON 28-5-88** — Cool & windy night (28). N.Q. Zone SB Night C'ship 25T 15m: OA: J. Edmonds 24-25; A: Rod Cusack 22-25; B: P. Weder 19-25; C: Diane Reeves 22-31; D: J. Wilkes 18-25; Lady: C. Weder 14-25; Junior: B. Schneekloth 14-25. Qld State DD C'ship 20PR 22m: 1st J. Edmonds & R. Keyes 17-20, 2nd Rod & Robbie Cusack 10-20.

**NORMANTON 29-5-88** — Fine, light wind (26). 10T DB Pts CD 15m: W. Mann 30-30, Rod Cusack 27-30, J. Wilkes 27-30, B. Schneekloth 27-30, T. Salisbury 26-30, B. McCracken 25-30, J. Edmonds, Robbie Cusack, M. McGill, P. Weder, M. Carr 24-30. Gulf Country Pts C'ship 25T 15m: OA: J. Edmonds 73-75; A: Rod Cusack 72-75; B: P. Weder 63-75; C: G. Bell 64-75; D: J. Wilkes 62-75; Lady: D. Reeves 63-75; Junior: B. Schneekloth 46-75. Carpentaria DB C'ship 25T 15m: OA: D. Reeves 24-25; A: K. Pearce 25-27; B: R. Keyes 19-25; C: G. Bell 23-25; D: K. Robinson 23-25; Lady: B. Schneekloth 19-25; Junior: R. Sellings 17-25. Annual Db Hop 25T: 1st Rod Cusack 24-25, 2nd G. Bell 33-35, 3rd C. Gillham; FM: B. Schneekloth 23-25. Carpentaria Classic won by Rod Cusack 148-155 after a shoot-off with Jim Edmonds 147-155. HG: OA: Rod Cusack 185-180; A: J. Edmonds 164-180; B: P. Weder 143-180; C: D. Reeves 138-180; D: J. Wilkes 151-180; Ladies: C. Weder 105-180; Junior: B. Schneekloth 129-180.

**ROCKHAMPTON 12-6-88** — Fine (62). 15T DB EO: B. Hopgood, F. Comino, N. Bartlem, K. Mackay, W. Scarborough, R. Kennedy, J. Keith, R. Maroske, D. Burns, M. Warnock, B. Nasser, R. Meaney, P. Rehbein, B. Meaney, D. Casagrande, 15-15. 25T DB Capricornia Dist C'ship: OA: W. Scarborough 196-196; AA: N. Bartlem 37-38; A: B. Hopgood 195-196; B: R. Smithwick 41-42; C: W. Whitfield 28-29. 15PR DR Capricornia Dist C'ship: OA: R. Meaney 29-30; AA: R. Maroske 28-30; A: B. Hopgood 28-30; B: J. Ryan 33-40; C: D. Wust 29-40. 25T DB Pts Capricornia SB Dist C'ship: OA: R. Meaney 75-75; AA: D. Casagrande 73-75; A: B. Hopgood 103-104; B: L. Dalton 71-75; C: D. Wust 91-99. 50T Medley: AA: N. Bartlem 49-50, W. Scarborough 68-70; A: J. Storch 86-90, P. Rehbein 84-90; B: C. Duffy 50-50, P. Wilson 48-50; C: M. Needham 55-60, W. Whitfield 54-60. 25T SB Capricornia Dist C'ship: OA: D. Burns 30-30; AA: R. Maroske 23-25; A: R. Meaney 29-30; B: J. Deeley 23-25; C: W. Whitfield 24-25. OA HG: R. Meaney 211-220, Ladies HG: V. Storch; Junior HG: C. Storch; FM HG: A. Morrice; B HG: J. Deeley; C HG: R. Kennedy.

**ST GEORGE 21-5-88** — Cool & overcast (19). 25T Pts 15m: 1st J. Ferrier, 2nd C. Spackman, 3rd M. Stewart. 20T SB 15m: 1st K. Symes, 2nd J. Ferrier, 3rd C. Spackman. 25T DB Hop: 1st R. Jones, 2nd C. Spackman, G. Graham, J. Ferrier. HG: J. Ferrier.

**ST GEORGE 18-6-88** — Fine & sunny (22). 25T Pts: 1st R. Jones, 2nd F. McEwan, 3rd R. Spackman, 4th G. Scudamore. 20T SB: 1st R. Spackman, 2nd K. Symes, 3rd W. Knights, 4th F. McEwan. 25T Hop: 1st F. McEwan, 2nd W. Turner, 3rd D. Melbin, 4th R. McDougal. 20T Cont: 1st D. Batterham, 2nd F. McEwan, 3rd T. Siddins, 4th K. Symes. HG: F. McEwan.

**SUNSHINE COAST 15-5-88** — (21). 25T Hop: 11-15m: G. Greening 23-25; 16-19m: Bill Stolberg 25-28; 20-25m: G. Fett 24-25. 25T DB Pts: A: G. Burlison 70-75; B: B. Grice 70-75; C: J. Wilson 65-75. 25T DB Cont Trophy: AA: G. Dixon 25-25; A: G. Goding 24-25; B: J. Burlison 22-25; C: J. Wilson 22-25. Monthly Mug: G. Fett, HG: AA: G. Fett 147-150; A: G. Burlison 137-150; B: B. Grice 135-150; C: J. Wilson 123-150.

**SUNSHINE COAST 19-6-88** — Fine, sunny, light wind (24). 25T DB CD: AA: G. Dixon; A: C. Miller, J. Edmonds, B. Grice, G. Burlison; B: J. Burlison, S. Gallagher, R. Dale; C: I. Campbell, J. Cassimatis, C. Greening. 25T Pts: AA: G. Dixon 70-75; A: B. Grice 71-78; B: J. Burlison 72-75; C: J. Cassimatis 66-81. 25T SB: AA: G. Dixon 22-25; A: G. Goding 24-25; B: J. Burlison 21-25; C: G. Greening 18-25. 25T Hop: 11-15m: D. Crosley 24-25; 16-19m: T. Dixon 22-25; 20-25m: G. Dixon 21-26. 10PR DR: AA: R. Fett 14-20; A: C. Miller 18-20; B: R. Dale 16-20; C: I. Campbell 10-20. The monthly mug was won by D. Crosley.

**TAMBO 4-6-88** — (8). 10T DB EO: C. Duffy, S. Goodman, A.J. Taylor, E. Johnston, A. Wale 9-10. 30T Patron's Trophy 15 off 15m, 15 off Hop: Equal 1st J. Taylor, J. Peckett, A. Wale 78-90, after shoot-off A.J. Taylor. Mug Event 25T SB: A.J. Taylor 23-25. 10PR DR: 1st A.J. Taylor 16-20, 2nd C. Duffy 15-20, 3rd A. Wale, D. Davidson 14-20. 10PR DD off 18m: A. Wale & D. Davidson 9-10.

**TERRANORA LAKES 12-6-88** — Excellent (26). 20T DB SS: A: L. Grace; B: P. Hinschen; C: J. Farrow. 25T DB Pts: A: J. Mitchell; B: P. Hinschen; C: A.

# BRISBANE GUN CLUB

## AUGUST 1988 SHOOT PROGRAM

Saturday 13th, Sunday 14th, Wednesday 17th —  
Refer separate advertisement this issue

### SUNDAY 28th COMBINED SKEET & TRAP

9.00a.m. SKEET  
EVENT 1 Nom. \$7.00

25 Target Doubles Cash Event

EVENT 2 Nom. \$7.00

25 Target Handicap Cash Event

EVENT 3 Nom. \$14.00

50 Target Stevens & Sons Cash

Scores on Event 3 to count for Stevens & Sons High Gun. Optional Jackpot for shooting the possible.

1.00p.m. TRAP  
EVENT 1 Nom. \$8.00

25 Target D/B 15m Cash Event

EVENT 2 Nom. \$8.00

25 Target Points 15m Cash Event

EVENT 3 Nom. \$8.00

25 Target S/B 15m Cash Event

Scores on Event 1 to count for Stevens & Sons, D. & S. Follett Annual High Gun Award

PLEASE NOTE: The club will be closed for practice on our competition days — 13th, 14th & 17th August and 21st-27th August due to the Queen's Rifle Shoot.

PRESIDENT: Tom Meadows (07) 286 2607  
CAPTAIN: John Porter (07) 398 4257

# TOOWOOMBA CLAY TARGET CLUB INC.

## FARMFEST NIGHT SHOOT WEDNESDAY NIGHT

7th SEPTEMBER

1988

Commencing 6.00pm

Barbecue Tea — Refreshments — Ammo available — Two Layouts

EVENT 1 Nom. \$8.00

25 Target Double Barrel Night Tower — Graded Trophies

EVENT SPONSORED BY CATERPILLAR

EVENT 2 Nom. \$8.00

25 Target Double Barrel Night Trap — Graded Trophies

EVENT SPONSORED BY ANI KOMATSU

Overall High Gun Troph.

Club Ground phone: 30 4175

K. Miller (Secretary) phone: 34 1265

# TERRANORA LAKES COUNTRY CLUB LIMITED

presents the

## T.L.C.C. CLAY TARGET CLUB BICENTENNIAL DAY/NIGHT SHOOT 27th AUGUST — 1.00pm

- EVENT 1 20 Target D/B A.B.C. Nom. \$6.00  
EVENT 2 20 Target D/B Points A.B.C. Nom. \$6.00  
EVENT 3 20 Target Single Barrel A.B.C. Nom. \$6.00

### BARBECUE TEA NIGHT PROGRAM:

- EVENT 4 20 Target D/B A.B.C. Nom. \$6.00  
EVENT 5 20 Target D/B Points A.B.C. Nom. \$6.00  
Total Noms: \$30.00

The committee reserves the right to alter program

Jackpot Shoot — Cartridges available —  
Excellent meal

Secretary:  
J.P. Mitchell

President:  
W. Lagoon

# GYMPIE CLAY TARGET CLUB INC.

Banks Pocket Rd, Gympie 4570

Affiliated with Australian Clay Target Association

## SUNDAY AUGUST 14 — 10.30am

25 Target D/B 15m Cash Divide  
25 Target Mixed Event — 5 D/B, 5 S/B,  
5 Pts, 5 PR D/B  
20 Target D/B Cont. Pts 15m  
15 Pr D/B D/R Tower

Jackpot to be shot

Reminder: October 8 shoot on 2nd Sunday,  
not as advertised in Q.C.T.A. book

# TERRANORA LAKES COUNTRY CLUB CLAY TARGET CLUB

presents

## 14th AUGUST 1988 — 10.00am

- EVENT 1 25 Target D/B Trophy A.B.C. Nom. \$7.00  
EVENT 2 25 Target D/B Points Trophy A.B.C. Nom. \$7.00  
EVENT 3 25 Target D/B Continental A.B.C. Nom. \$7.00  
EVENT 4 25 Target D/B Club Bicentennial Handicap Championship Nom. \$10.00  
11-15, 16-20, 21-25  
Total Noms: \$31.00  
Optional Graded Sweep \$3.00: \$34.00

Luncheon — Jackpot Shoot

Committee reserves the right to alter or change program  
Practice available 1.00pm Sundays

Please note: Annual Day/Night shoot  
on 27th August

Guthrie. 30T Medley: A: J. Duyker; B: P. Hinschen; C: J. Wilson. 25T Hop: 11-15m: J. Wilson 22-25; 16-20m: J. Grace 23-25; 21-25m: J. Duyker 22-25.

TOOWOOMBA 12-6-88 — Fine (28). 50T Skeet Grd SS: A: D. Dundon 50-50, N. Dimmick 46-50, T. Robinson 37-50; B: V. Tipman 44-50, D. Knight 38-50; C: G. Lippert 48-50, M. Reinbott 42-50, W. Sattler 41-50. 25T Pts Grd SS: A: T. Robinson 70-75, J. Harris 64-75, V. Tipman 51-75; B: J. Bourke 73-75, D. Heslin 60-75, G. Lippert, J. Cuddihy 58-75; C: M. Reinbott 66-75, A. Adams 64-75, G. Peterson 63-75. 25T Toowoomba DB C'ship: OA & A: N. Gowland 35-38; B: J. Bourke 34-38; C: C. Rowlands 25-27. 25T DB Hop: 1st J. Bourke 27-29, 2nd A. Adams 26-29; Jnr HG: T. Lippert 90-125; C11-15m HG: A. Adams 105-125; Trap HG: J. Bourke 120-125.

TOWNSVILLE 25-6-88 & 26-6-88 — Very windy & cool (39). Results of NZQCTA Skeet Carnival — Skeet Team: Neil Hardy, Mick McGill, Arthur Kenna, Tom Comerford, Barry Edwards, Angelo Zappala. Northern Zone Championship: OA: N. Hardy 97; A: A. Kenna 95; B: B. Edwards 92; C: B. Grice 92; D: G. Woollam 82. Bicentennial Championship: OA: A. Kenna 50; A: N. Hardy 48; B: T. Comerford 49; C: G. Archer 46; D: G. Woollam 43. OA 150 Targets: N. Hardy 150-155.

WANDOAN 19-6-88 — Fine. 10t DB 15m: A: D. James 10-10; B: G. Mason, M. Dinnis, W. Sattler, L. Kearney 10-10; C: R. Woodrow 8-10. 25T Cont 15m Champion of Champions: A: D. James 22-25; B: P. Jones 24-25; C: R. Woodrow 20-25. 50T Cont Pts State 15m: OA: R. Knapp 145-150; A: R. Zeisler 130-150, D. James 124-150; B: W. Sattler 138-150, G. Mason 131-150; C: G. Gilroy. 25T Pts Hop: 1st L. Kearney 66-75, 2nd J. Mitchell 64-75, 3rd D. James 62-75. HG: R. Knapp.

WARWICK 5-6-88 — "Wellies" & Canoes essential (17). Owing to inclement weather advertised programme was not held. Three sweepstakes events were held instead. 25T DB SS: AA: G. Newey; A: L. Shenco; B: A. Finlayson, B. Hope, D. Gibson, R. Starr; C: J. Hodgson, E. Eurawski, L. Smith. 25T Pts: AA: G. Newey; A: L. Shenco; B: J. Hodgson, P. Evans, D. Cameron; C: L. Smith, E. Surawski, G. Lane. 25T SB: AA: G. Newey; A: L. Shenco; B: R. Starr, R. Hamill, A. Carpenter, B. Hope, D. Gibson, J. Hodgson; C: E. Surawski, L. Smith, P. Gill, R. Turnham.



NEW SOUTH WALES

ALBURY WODONGA 12-6-88 — Foggy, then fine (43). 10T Pts EO: G. Boyd, I. McGeogh, N. Hore, T. Hodge, D. Jackel, all shot possibles. 20T Southern Riverina Zone Pts C'ship: A & OA: A. Collins 60-60, G. Boyd 71-72; B: T. Plum 68-69, E. Dowling 67-69; C: M. Liersch 56-60, L. Noretta 51-60. 50T Keith Hodge Memorial DB C'ship: A & OA: R. Ehlers 71-71, R. Blake 49-50, A. Collins 51-53; B: N. Hore 70-71, S. Ziegler 49-50, T. Plum 60-63; C: G. Macklan 49-52, M. Liersch 48-52, C. Milthorpe 46-50; Veterans: D. Gittings 42-50; Juniors: C. Milthorpe 46-50. HG: N. Hore 138-140. Winning team: Albury-

Wodonga: R. Ehlers 50-50, N. Hore 50-50, G. Pinner 48-50, I. McGeogh 47-50, G. Boyd 46-50.

**BARELLAN 12-6-88** — Fine & sunny (28). 10T DB Hep: Ron Rixon, K. Whytcross, both shot possibles. 20T Hep: OA: P. Payten; 11-14m: 1st R. Shimpf, 2nd E. White; 15-17m: 1st G. Schmetzer, 2nd A. Raadgever; 18-25m: 1st G. Dennis, 2nd S. Papisidero; Junior: D. Graham. 10T PS 15m: L. Irwin, G. Schmetzer, both shot possibles. 10T SB Hep: L. Wisely 10-10, G. Dennis, D. Lucas, E. White 9-10.

**BATHURST 5-6-88** — Cold, wet, windy (7). 25T Skeet Hep: L. Aberley 24-25. 50T Skeet C'ship: OA: J. Harris 44; A: L. Aberley 31; B: R. McRobert 41; C: R. Campbell 42. 25T CD: R. McRobert 24, L. Aberley 22, J. Harris 21. 25T DB: R. McRobert 19-25 after shoot-off with L. Aberley. HG: L. Aberley 87, J. Harris 84, R. McRobert 83.

**BATHURST 19-6-88** — Cool, cloudy (7). 10T DTL EO: L. Arnold, L. Aberley 10-10, P. Haley, R. Campbell 9, G. Blaitman, F. Johns 8. 25T PS: OA: R. Campbell 72; AA: L. Arnold 66; A: L. Aberley 63; B: F. Johns 64; C: B. Corsmak 53. 25T Hep: P. Haley 25, F. Johns 24, B. Corsmak 23. 25T 16m CD: P. Haley 24, L. Arnold 23, B. Corsmak 22, R. Campbell 22.

**BEGA 5-6-88** — Rainy & muddy (20). 10T DB Hep: C. Davis, C. Allen, T. Smith, B. Mackay. 25T PS C'ship: 1st E. Koeller, 2nd D. Blewitt, 3rd B. Deacon. 25T Frog 5 x 12 + 5 x 15 + 5 x 18 + 5 x 21 + 5 x 25: 11-14m: R. Welch; 15-18m: J. Stewart; 19-25m: E. Koellner. 5T 18m DB: B. Deacon. FM: D. Etone. HG: E. Koellner.

**BOGGABRI/GUNNEDAH 11-5-88** — Good (Poor, 14). 10T EO CD 15m: A: G. Carlyon, V. Eather 10-10; B: J. Hodges 10-10; C: T. Ralte, D. Campbell 9-10. 5T Elimination 15m DB: 1st K. Grover 11-11, 2nd D. Campbell 10-11, 2nd G. Carlyon 8-9. 25T Hep CD: Equal 1st T. Aceti, G. Carlyon 23-25, equal 3rd D.

### GOULBURN WORKERS GUN CLUB

### CHANGE OF DATE

### PRE-STATE CARNIVAL CHAMPIONSHIPS

is now scheduled to be conducted on September 18, not on September 11 as previously advertised.

Starting time remains at 11.30am

# BOGGABRI-GUNNEDAH GUN CLUB

## 6th ANNUAL AG-QUIP SHOOT WEDNESDAY, AUGUST 24, 1988 Commencing — At Night BARBECUE

**EVENT 1** 10 Target D/B Eye Opener 15m Cash Divide **Nom. \$5.00**  
**EVENT 2** 30 Target Ag-Quip Championship **Nom. \$20.00**

1st O/A Trophy and Badge. 1st & 2nd A.B.C. Trophy.  
Opt. Sweeps 1st 15 - \$1.00, 2nd 15 - \$1

Here is your chance to see AG-QUIP, the largest agricultural field days.

Camping facilities available to shooters.

Reminder 22nd Annual Gum Tree Championships on October 1 and 2 at Boggabri. Looking forward to seeing you.

President: Vic Eather  
Laidlaw St.,  
Boggabri 2381  
Phone (067) 43 4588

Stuart Stanley  
23 Palmer Cres.,  
Gunnedah 2380  
Phone (067) 42 2473

# ALBURY WODONGA CLAY TARGET CLUB INC.

## SUNDAY AUGUST 14 . . . 11am start Skeet.

## 12.30 start DTL

- |  |                   |
|--|-------------------|
| Event 1. 25t John R. Boyd P/L Skeet Ch'ship<br>OA & 2 grade winners.                           | Noms. \$8, OS \$1 |
| Event 2. 10t Eye Opener  | Noms. \$3.00      |
| Event 3. 20t Anderson's Village Take Away D.B. Ch'ship<br>OA, 2 grade winners, 2nd each grade. | Noms. \$7, OS \$1 |
| Event 4. 25t Mixed Target Championship<br>OA & 2 grade winners.                                | Noms. \$8, OS \$1 |
| Event 5. 10pr Double Rise Championship<br>OA & 2 grade winners.                                | Noms. \$7, OS \$1 |

\$150 open order with IAN McGEOCH GUNSMITHS for possible shot over the program.

Don't forget our October Anniversary Shoot sponsored by Ian McGeoch Gunsmiths — Trophies include 2 Franchi Shotguns, 3 Brno Rifles, 3 cases shells.

President:  
R. Petts (060) 25 1239

Secretary:  
D. Smailes (060) 21 5433

# INVERELL RSM GUN CLUB BICENTENNIAL OPEN SHOOT

## 200 YEARS 200 TARGETS RED FLURO—15 METRES

### AUGUST 20TH & 21ST 1988

9 a.m. Start Each Day

#### SATURDAY

**EVENT 1** Noms \$10.00  
**MACINTYRE DIST D/B C'SHIP**

Sponsor Pauline & Ross  
Campbell Shell Agents  
25T O/A Sash Badge & Trophy  
Badge & Trophy 1st AA, A, B, C  
Trophy 2nd & 3rd AA, A, B, C  
Graded Optional Sweeps \$3.00

**EVENT 2** Noms \$20.00

**RSM BICENTENNIAL D/B C'SHIP**

Sponsor: Inverell RSM Club Ltd  
50T D/B O/S Sash Badge & Trophy  
Trophy 1st, 2nd & 3rd AA, A, B, C  
Graded Optional Sweeps \$3.00

**EVENT 3** Noms \$10.00

**MACINTYRE DIST P/S C'SHIP**

Sponsor: Elders Pastoral  
25T O/S Sash Badge & Trophy  
Badge & Trophy 1st AA, A, B, C  
Trophy 2nd & 3rd AA, A, B, C  
Graded Optional Sweeps \$3.00

#### SUNDAY

**EVENT 4** Noms \$12.00  
**MACINTYRE DIST GRAND CLASSIC  
C'SHIP**

Sponsor: Commonwealth Bank of Australia  
25T D/B 15m  
O/A Sash Badge & Trophy  
Badge & Trophy 1st AA, A, B, C  
Trophy 2nd & 3rd AA, A, B, C  
Graded Optional Sweeps \$3.00

**EVENT 5** Noms \$20.00  
**\$1,000 CASH DIVIDE & CALCUTTA**

50T Points Score  
Divided \$250 ea grade AA, A, B, C  
INCLUDING: Sapphire City Inter-Club Teams Cup  
Sponsor: C.L.A.S.S.  
3 shooters per team — same club affil.  
Any number of teams per club  
Badge & Trophy — Members of 1st team

**EVENT 6** Noms. \$6.00  
**GRADED CASH DIVIDE AA, A, B, C**

25T D/B Continental 60% 30% 10%

**NOMINATIONS \$78.00 WITH SWEEPS \$90.00**

Committee reserves the right to alter program  
Half Noms for Veterans, Ladies & Juniors shooting each full day

**O/ALL HIGH GUN ON EVENTS 1 TO 6 — BICENTENNIAL SASH & TROPHY  
HIGH GUN — BICENTENNIAL SASH EACH GRADE AA, A, B, C  
HIGH GUN — Ladies, Veterans & Juniors (3 or more shooters)**

All High Guns proudly sponsored by: T.J. & P.V. NUNAN PTY LTD  
Hot lunches and refreshments available both days. Ammunition also available.

**CALCUTTA & COMPLIMENTARY TEA SAT NIGHT AT CLUB HOUSE — BBQ**  
Compliments of Burtenshaws Butchery  
Other Sponsors: Beaurepaires Tyres

*Club situated 2.5km east of Inverell on Gwydir Highway*

President: Peter Jensen  
(067) 223723 BH  
(067) 231416 AH

Secretary: Russell Kingsmill  
56 George St INVERELL  
(067) 225383

Campbell, G. Torrens. 25T Cont DB 15m: A: G. Carlyon 24-25, B. Hodges 22-25; B: K. Grover 22-25, J. Hodges 21-25; C: D. Campbell 22-25, J. Varcoe 17-25. HG: A: G. Carlyon; B: K. Grover; C: D. Campbell.

**BOMBALA 18-6-88** — Cold (16). 10T DB CM: Divided: B. Elliott, R. Elliott, G. Feilen, R. Brown, H. Kennedy, S. McIntyre. Club Trophy 5SB, 5DB: D. Badewitz. 20T DB Hop: 1st O. Benson, 2nd J. Peardon, 3rd D. Badewitz. 10T PS CM: 1st R. Brown, 2nd H. Kennedy, 3rd D. Badewitz. HG: H. Kennedy.

**BOOROWA 28-5-88** — Cold & wet (15). 20T Hop: R. Percival 19-20, R. Murphy 18-20, D. Corcoran 16-20. 30T DB 15m: OA: J. Blazley 79-80; A: J. Rus 74-80; B: M. Campbell 71-80; C: R. Percival 71-80.

**BREWARRINA 30-4-88** — Very good (20). 10T DB 15m CD: A. Neilsen, W. Dewhurst, W. Reichter, B. Powell, I. Light, A. Schmidt, C. Betts, C. Peter, P. Fitzalan, G. Haig. 25T PS Barwon & District C'ship: A & OA: C. Betts; B: C. Peters; C: A. Howison. 25T DB Barwon & District C'ship: A & OA: B. Schmidt; B: A. Schmidt; C: A. Neilsen. 25T SB Barwon & District C'ship: A & OA: B. Walton; B: D. Boyd; C: T. Hudson. 10T SB Cont CD: 1st C. Haig, 2nd C. Betts, 3rd M. Betts. 30T Night Cont Western Zone C'ship: A & OA: C. Betts; B: W. Reichler; C: P. O'Connor.

**BREWARRINA 1-5-88** — Warm and sunny (18). 30T DB Hop President's Trophy: 1st A. Schmidt, 2nd A. Neilsen, 3rd D. Dunstan. 20T PS Hep John Ryan Memorial Trophy: 1st A. Neilsen, 2nd D. Dunstan, 3rd D. Boyd. 10PR DR 15m Barwon & District C'ship: A & OA: M. Betts; B: W. Reichler; C: A. Neilsen.

**CANBERRA INTER. 24-5-88** — Wet. 10T CD: G. Kazous, B. Prosser, M. Holland 10-10. A.C.T. Night DB C'ship: OA: A. Beavan 29-30; AA: P. Simon 22-24; A: F. Rees 24-26; B: R. Bevan 28-30; C: C. Kazous 16-20.

**CANBERRA INTER. 29-5-88** — Fine. 100T NSW Southern Zone Ball Trap C'ship: OA & B: D. Bennett 92-100; AA: J. Ellis 141-150; A: N. Simms 85-100; C: L. McIntyre 78-100.

**CANBERRA INTER. 19-6-88** — Overcast, cold. 100T Gungahlin Olympio Trap C'ship: OA & A: N. Simms 88-100; AA: M. Diamond 87-100; B: J. Taylor 87-100; C: B. Kazolis 67-100.

**COFFS HARBOUR 28-5-88** — Balmey, sunny (5). 100T Skeet (25T Skeet Hop, 25T Skeet, 25T Skeet Doubles, 25T Skeet): OA: 1st R. Palmer 88-100, 2nd J. Williamson 81-100, 3rd D. Chambers 68-100 (25T Skeet Hop winner: D. Seccombe 25-25). HG: R. Palmer 88-100.

**COFFS HARBOUR 11-6-88** — Perfect, sunny. 20T DB 15m: J. Farrell, D. Chambers 20-20, I. Lupton 19-20. 20T PS 15m: J. Cunningham, J. Farrell 59-60, P. Young 55-60. 25T DB Hop Cunningham Cup: M. Dunn 26-26, T. Bernardis 26-26, P. Young 23-25. 15T DB Cont: B. Pendock, J. Farrell 14-15, I. Lupton 13-15. HG: J. Farrell 112-120.

**COFFS HARBOUR 18-6-88** — Warm, sunny (24). 50T Skeet Hop: N. Dimmick 85-85, D. Chambers 84-85, D. Dundon 87-88. 50T Coffs Harbour & District Skeet C'ship: AA & OA: D. Siggs 63-64, D. Dundon 62-64; A: M. Barton 48-50, T. Long 46-50; B: L. Buxton 48-50, C. Herbert 46-50; C: M. Dunn 45-54, J. Kerr 44-54.

**COFFS HARBOUR 19-6-88** — Warm, sunny (24). 50T Zone Skeet Elimination: OA: D. Siggs 86-86; AA: D. Siggs 86-86, R. Clarke 84-85; A: T. Long 85-86, M. Barton 84-85; B: H. Dare 46-50, B. Pendock 45-50; C: P. Smith 45-50, D. Chambers 45-50. Team Elimination: R. Melville 98, K. Weatherall 98, G. Walters 98, D. Jackes 95, B. Clarke 93, C. Herbert 93; Reserves: R. Palmer 91, M. Dunn 89, H. Dare 89, B. Pendock 88, D. Chambers 87, R. Shepherd 80, J. Garrett 69. 50T Banana Coast Skeet C'ship: OA: D. Siggs 64-64; AA: D. Siggs 50-50, D. Dundon 67-68; A: N. Dimmick 50-50, G. Walters 49-50; B: C. Herbert 49-50, L. Buxton 47-50; C: M. Dunn 48-50, D. Chambers 52-58.

**COLEAMBALLY 11-6-88** — Overcast & cold (17). 10T DB 15m EO: 6 possibles: K. Shields, C. Shields, D. Lucas, P. Ledwidge, G. Evans, S. Papisidero. 30T M/T Bicentennial Event: A: S. Papisidero 104-104, P. Woodman 103-104; B: B. Wild 53-60, M. Lorenz 52-60; C: K. Harris 43-50, E. Lorenz 35-50; Veteran: D. Lucas 44-50. 15T PS 15m: K. Shields 45-45, G. Evans, S. Papisidero 43-45. 15T SB 15m: P. Woodman, S. Papisidero 14-15, K. Shields, B. Shields, M. Lorenz, D. Lucas, P. Ledwidge, G. Evans 13-15. HG: S. Papisidero 117-120.

**COWRA 4-6-88** — Fine, warm, turning cloudy (29). Sweep — 10T off 15m: 8 possibles: R. Peters, D. Toshack, G. Sinclair, J. Rue, N. Dwight, J.W. Smith, J. Lawrence, D. Piotrowski. Jackpot Trophy 20T off Hep: M. Campbell 20-20, D. Fairall 35-36, L. Louie 34-36. Champion of Champions (10T DB, 10T SB, 10T PS off 15m): OA & AA: D. Fairall 60-60, J.W. Smith 59-60; A: D. Toshack 47-50, J. Rus 56-60; B: G. Campbell 49-50, M. Campbell 48-50; C: R. Peters 51-60, P. Simeon 47-50. HG: D. Piotrowski 84-85; Encouragement award: K. Maguire.

**DENLIQUIN 19-6-88** — Good, slightly overcast and breezy (36). 10T PS EO: 3 possibles: D. Bond, B. Cakebread, A. Schirmer. 20T PS C'ship: Possibles shot by W. Headon and J. Smith; A: W. Headon 60-60; B: J. Smith 60-60; C: W. Forbes 55-60. 20T Hop CD: 4 possibles were shot: M. Roberts, D. Bond, T. Maher, R. Allen. 25T DB C'ship: 7 possibles: B. Cakebread, W. Headon, R. Decker, T. Thomas, A. Schirmer, T. Smith; OA & A: W. Headon 80-80, B. Cakebread 78-78; B: T. Thomas 79-80, A. Schirmer 67-68; C: T. Maher 23-25, W. Forbes 22-25. 10T Club Mug: Won by J. Smith 11-11; possibles shot by J. Smith & M. Fragiaco.

**GLEN INNES 5-6-88** — Overcast & drizzly (20). 25T DB PS 15m: A: A. Futter 72-75, R. Kingsmith 71-75; B: P. Wright 68-75, A. Kempton 61-75; C: C. Hollis 75-75, H. Finch 64-75. 25T Club DB C'ship 15m: A: P. McGuire 24-25, N. Campion, A. Futter, M. McCosker 23-25; B: D. Cunningham 23-25, I. Lupton 22-25; C: C. Kent 28-30, C. Hollis 27-30. 25T DB Cont 15m: A: A. Futter 20-20, P. McGuire, B. Finch, C. Bloxsome 19-20; B: I. Lupton 20-20, D. Cunningham, P. Wright 19-20; C: C. Hollis, M. Lupton 20-20.

**GOULBURN 13-6-88** — Cool & sunny. 10T PS: C. Rowe, P. Croker, I. Shuttle 30, S. Goodridge, F. Roberts, G. Geering, I. Marsh 29, M. Freestone, G. Hatherley 28. 30T Mixed: AA: N. Bradbury 123, L. Hearne 120; A: S. Keys 110, M. Freestone 106; B: J. Marsh 102, A. Beavan 101; C: J. Pace 91, G. Todd 93; OA: F. Roberts 117-120. 20T Hop: 1st S. Keys 20-20, 2nd C. Rowe 19-20, 3rd G. Hatherley 19-20.

**GRAFTON 29-5-88** — Fine & clear (16). 25T DB 15m: A: J. Farrell 25-25; B: M. Harrison 25-25; C: L. Morris 24-25. 25T DB Fts 15m: A: S. Godwin, R.

# SYDNEY CLAY TARGET CLUB LTD

## AUGUST 1988 PROGRAM

### FRIDAY 12 — 6.30pm

- EVENT 1** Nom. \$6.00  
20 Target D/B E/O
- EVENT 2** Nom. \$7.00 O/S \$1.00  
15 Target D/B Handicap
- EVENT 3** Nom. \$10.00 O/S \$1.00  
30 Target D/B Trophy

### SUNDAY 14 — 10am

- EVENT 1** Nom. \$15.00  
50 Target Skeet Handicap  
1st, 2nd, 3rd, 4th

### 12 NOON

- EVENT 2** Nom. \$6.00  
20 Target D/B E/O
- EVENT 3** Nom. \$15.00 O/S \$3.00  
50 Target D/B Trophy
- EVENT 4** Nom. \$9.00 O/S \$1.00  
25 Target P/S Championship

### FRIDAY 26 — 6.30pm

- EVENT 1** Nom. \$6.00  
20 Target D/B E/O
- EVENT 2** Nom. \$15.00 O/S \$3.00  
50 Target D/B Championship

### SUNDAY 28 — 12 NOON

**Sydney-Marconi 100 Targets Trap  
Championship**  
Noms. including O/S \$35.00  
O/A 1st & 2nd each grade

**Graham Boyce (02) 726 8638 or Wal Sully  
(02) 605 3207**

# TAMWORTH CLAY TARGET CLUB LTD.

## ANNUAL OPEN TRAP SHOOT

3RD & 4TH SEPTEMBER, 1988

\$7,000 IN TROPHIES AND SASHES — 215 TARGETS — \$108.00

### SATURDAY 9.00am

**EVENT 1** Nom. \$12.00  
30 TARGET COUNTRY CAPITAL DOUBLE BARREL  
CHAMPIONSHIP

*Sponsored by TAMWORTH COMBINED AGENTS*  
O/A Sash, Badge & Trophy value \$150  
1st in each grade trophy value \$100  
2nd in each grade trophy value \$80

**EVENT 2** Nom. \$12.00

25 TARGET DOUBLE BARREL HANDICAP TROPHY  
*Sponsored by VERSALITE WINDOWS*  
Trophies 1st to 6th place value \$165, \$135, \$105, \$75,  
\$60, \$45

**EVENT 3** Nom. \$20.00

30 TARGET COUNTRY CAPITAL DOUBLE BARREL  
CLASSIC

*Sponsored by HISCOCKS SPORTS STORE*  
O/A Sash, Badge & Trophy value \$300  
1st in each grade trophy value \$135  
2nd in each grade trophy value \$80

**EVENT 4** Nom. \$10.00

25 TARGET DOUBLE BARREL HANDICAP CASH DIVIDE  
11-15m, 16-18m, 19-22m, 23-25m

**SATURDAY NIGHT — CALCUTTA AUCTION**  
*Comp. tea at the Club House*

### SUNDAY 9.00am

**EVENT 5** Nom. \$12.00  
30 Target COUNTRY CAPITAL POINT SCORE  
CHAMPIONSHIP

*Sponsored by INDEPENDENT COMMUNICATIONS*  
O/A Sash, Badge & Trophy value \$150  
1st in each grade trophy value \$100  
2nd in each grade trophy value \$80

**EVENT 6** Nom. \$10.00

25 TARGET DOUBLE BARREL HANDICAP CASH DIVIDE  
11-15m, 16-18m, 19-22m, 23-25m

**EVENT 7** Nom. \$20.00

25 TARGET COUNTRY CAPITAL DOUBLE BARREL  
HANDICAP

*Sponsored by FOSTERS FIREARMS — TAMWORTH*  
CALCUTTA EVENT  
Trophies 1st to 6th place  
\$300, \$225, \$185, \$150, \$105, \$75

**EVENT 8** Nom. \$12.00

25 TARGET DOUBLE BARREL CONTINENTAL

*Sponsored by VERSALITE WINDOWS*  
O/A Sash, Badge & Trophy value \$150  
1st in each grade trophy value \$100  
2nd in each grade trophy value \$80

**OVERALL HIGH GUN SASH — COUNTRY CAPITAL CUP  
& TROPHY Value \$500**

*over events 1 to 8 sponsored by  
INDEPENDENT COMMUNICATIONS*

15 Metre High Gun Sash & Trophy value \$160 over events 1,3,5&8

HANDICAP HIGH GUN SASH & TROPHY VALUE \$160 OVER EVENTS 2, 4, 6 & 7

AA.A.B.C. Grade High Gun Sashes & Trophies over events 1-8

LADIES — JUNIOR — VETERANS HIGH GUN SASHES & TROPHIES OVER EVENTS 1-8

COMMONWEALTH BANK HIGH GUN CUP — TAMWORTH MEMBERS ONLY — EVENTS 1-8

2 MEMBER TEAMS MATCH — EVENTS 1-4 — LINDSAY BULL MEMORIAL SHIELD

4 MEMBER TEAMS MATCH — EVENTS 5-8 — COUNTRY CAPITAL PRESIDENT'S CUP

Ladies & Juniors Half Nominations — Morning & Afternoon Tea — Lunch — Refreshments — Cartridges  
available — Camping available on the grounds — Power and hot showers available

**PRESIDENT: Geoff Walters**  
(067) 67 6238

**SECRETARY: Rod Prior**  
Bus: (067) 66 1455; A.H. (067) 66 1537

Burton 74-75; B: M. Harrison 69-75; C: L. Morris 64-75. 25T DB 15m: A: P. McGuire, J. Farrell, G. Harrison 25-25; B: J. Cunningham 24-25; C: L. Morris 23-25. 25T DB Cont 15m: A: R. Burton, G. Harrison 25-25; B: M. Harrison 22-25; C: L. Morris 20-25.

GRENFELL 8-6-88 — Cool, breezes. 10T DB EO 15m: I. Halls, J. Carter, J. McCann 10-10. 15T DB Hop: I. Halls 15-15, P. Walmsley 14-15, P. Cram, R. Orr, J. Gorman 13-15. 20T DB 15m: P. Walmsley 19-20, I. Halls 18-20, N. Butt 18-20. 15T SB 15m: N. Butt, I. Halls, R. Orr 12-15. 15 Mixed 5T DB, 5T PS, 5T SB: I. Halls 25-25, R. Orr 24-25, J. Gorman 23-25.

GRENFELL 12-6-88 — Cool, slight breezes (33). 10T DB EO 15m: J. McCann, P. Mould, G. Sinclair, J. Rue, B. Cole, P. Coddington, T. Murray 10-10. 25T DB Henry Lawson C'ship: 1st D. Fairall 24-25, 2nd B. Cole 24-25, 3rd I. Halls 24-25. 20T DB Henry Lawson Hop: P. Walmsley 18-20, T. Lynch 17-20, A. Drogemuller 16-20. Henry Lawson Shield (Hop over 100T): I. Halls, P. Walmsley, J. Carter, J. Gorman, J. McCann 80-100. 25T SB Henry Lawson C'ship 15m: P. Walmsley 23-25, B. Cole 23-25, J. Rue 21-25.

HAWKESBURY 13-6-88 — 20T DB EO: N. Burrows, P. Muscat, S. Zadro Jr 20-20. 20T PS CD: A: P. Muscat 58-60, E. Zadro 57-60; B: N. Burrows 59-60, R. Hibbert 54-60; C: P. Vella 57-60, B. Robinson 57-60. 25T Hawkesbury District PS C'ship: OA: R. Hibbert 70-75; A: P. Farrugia 69-75; B: A. Zadro 68-75; C: C. Vestergaard 69-75.

HAWKESBURY 14-6-88 — Fine, warm (36). 50T Skeet C'ship: OA: R. Clarke 48-50; A: J. Wilberforce 48-51; B: L. Tosolini 41-50; C: G. Kable 43-50.

HAWKESBURY 27-6-88 — Cool, fine (41). 20T DB Cont EO: J. Gobbo 20-20, N. Burrows 19-20. 20T DB Cont CD: A: M. Newman 20-20, E. Zadro, K. Bosanko, N. Burrows 19-20; B: V. Gobbo, G. Kable 19-20; C: N. Xenos 18-20, B. Robinson, S. Zadro 17-20. 25T PS Cont C'ship: OA: N. Burrows 73-76; A: E. Zadro 66-75, J. Vella 66-75; B: V. Gobbo 71-75, G. Kable 69-75; C: P. Vella 65-75, S. Zadro Jr 62-75.

HERMIDALE 29-6-88 — Cold, rainy (10). 10T EO Hop: S. Monaghan. 20T PS 15m: 1st B. Powell, 2nd T. Kitto, 3rd G. Kilmartin. 30T P.O. Trophy Mixed Targets: 1st B. Fitzalan, 2nd S. Monaghan, 3rd R. Sullivan. 30T J.E. Trophy Hop: B. Fitzalan. 20T Cont 15m: 1st T. Kitto, 2nd G. Kilmartin, 3rd B. Powell. 10PR DD 13m: 1st T. Hudson, B. Powell, 2nd T. Kitto, R. Sullivan, 3rd W. Dewhurst, J. Francis.

INVERELL 18-6-88 — Fine, sunny (28). 25T Ball Trap Club Hop: J. Kent 24-25. 25T DB CD 15m: Possibles shot by B. Leadbitter & R. Vidal. 25T PS C'ship: AA & OA: D. Ellis 75-75; A: A. Futter 74-75; B: B. Leadbitter 68-75; C: R. Rolfe 60-75. 20T Hop: 1st B. Leadbitter 22-23, 2nd P. Jensen 21-23. HG: R. Vidal 152-160, D. Ellis 151-160.

KEMPSEY 18-6-88 — Fine, clear, still (20). 10T DB CD 15m: N. Nugent, E. Baker, R. Pritchard, G. Schubach, R. Booth 10-10. 25T Cont Hop: OA & A: W. Neill 26-26, B. Edwards 25-26; B: D. Edwards 27-29, A. McWhirter 28-29; C: A. Colman 23-29, J. Mathiske 22-29. 10T DB Hop: D. Schubach, A. Colman, R. Hooper, G. Schubach, A. McWhirter, D. James 10-10. 15T SB 15m: D. Edwards, B. Edwards, A. Fotheringham 15-15. HG: W. Neill 79-84 after shoot-off from B. Edwards 78-84, R. Pritchard 63-68.

LEETON 22-6-88 — Cloudy with showers (29). 10T DB EO 15m: 15 possibles: A. Raadgever, I. Whyteross, A. Paonne, P. Foote, W. Coraci, F. Schmetzer, L. Brissenden, G. Evans, I. Evans, C. Salafia, M. Stannmore, S. Coely, T. Salafia, N. McDermott, J. Blain. 25T DB C'ship 15m: 10 possibles: OA: A. Paonne 225-225; A: C. Salafia 224-225; B: AA. Raadgever 24-25; C: W. Coraci 23-25. 20T DB Hop: 2 possibles: A. Raadgever, L. Charles. HG: A. Raadgever.

MARCONI 29-6-88 — Fine (50). EO: 7 possibles. City of Parramatta DB C'ship: AA & OA: F. Twarloh 33-33, P. Farrugia 32-33; A: L. Trew 31-32, P. Bortolin 30-32; B: B. Frampero 25-26, A. Lloyd 24-25; C: J. Kidd 23-25, J. Twarloh 21-25. City of Parramatta DR C'ship: AA & OA: B. Samuels 27-30, P. Farrugia 26-30; A: P. Pontello 43-50, P. Bortolin 41-50; B: D. Jenkins 20-30, W. Sully 25-40; C: D. Salvaggio 16-30, M. Schmitt 15-30. Club DD C'ship: L. Trew & I. Petrina 19-20, B. Samuels & R. Bown 18-20, P. Pontello & S. Toson 17-20. HG: P. Farrugia 56-60.

MARCONI 27-6-88 — Mild night (23). 15T CD DB: 2 possibles. 15T CD PS: 1 possible. 15T SB: AA: G. Rootes 14-15, C. Davenport 10-15; A: L. Trew 14-15, I. Petrina 12-15; B: W. Sully 13-15, P. Ammoun 12-15; C: A. Salem 12-15, J. Kim 10-15. 20T DB C'ship: AA & OA: C. Davenport 20-20, J. Boulos 19-20; A: L. Trew 19-20, A. Draper 20-21; B: P. Ammoun 20-21, D. Jones 19-20; C: D. Salvaggio 19-20, J. Kim 18-20. HG: G. Rootes 89-95.

MARCONI 10-6-88 — Wet night (20). 15T EO DB: 1 possible. 15T EO PS: 1 possible. 15T Hop: P. Ammoun 14-15, J. Kim 13-15, J. Boulos 13-17. 20T DB C'ship: AA: C. Davenport 17-20, K. Bosanko 16-20; A & OA: I. Petrina 19-20, L. Trew 16-20; B: P. Ammoun 19-20, W. Sully 18-22; C: J. Kim 20-24, D. Salvaggio 19-20. HG: L. Trew 81-95.

MARCONI 13-6-88 — Fine (53). EO: 1 possible. Club PS C'ship: AA: K. Bosanko 75-78, F. Twarloh 72-78; A & OA: G. Kidd 73-75, B. Samuels 81-84; B: P. Ammoun 70-75, S. Zardo 68-75; C: J. Puce 82-87, H. Poulos 81-87. Holroyd SB C'ship: AA: P. Farrugia 24-25, K. Bosanko 26-28; A & OA: C. Grina 25-25, J. Rapisarda 23-25; B: C. Luccarda 24-25, P. Ammoun 25-29; C: H. Poulos 23-25, A. Magri 25-29. Holroyd DB C'ship: AA: A. Piazza 29-30, J. Boulos 30-31; A & OA: G. Kidd 30-30, P. Bortolin 29-30; B: B. Frampero 29-31, D. Geddes 28-31; C: H. Poulos 24-26, A. Magri 23-26. HG: P. Farrugia 162-170.

MOULAMEIN 11-6-88 — Good (14). 10T DB SS: R. Dunn 10-10, A. Ferguson, C. Weaver 9-10. 20T DB SS: R. Weaver 10-10, P. Dunn, S. Fraser 9-10. 10T DB SS: R. Weaver 10-10, S. Fraser, A. Ferguson, R. Dunn 9-10. 10T SB Hop "Club Mug" Rod Dunn 10-10, C. Weaver 9-10.

NAROOMA 12-6-88 — Fine (24). 10T Cont 15m: 3 possibles: M. Deacon, A. Deacon, B. Mackay. 25T Cont Hop: M. Deacon 24-25, A. Deacon 26-30, J. Stone 25-30. 25T PS 15m: A: A. Deacon 70-75; B: R. Elliott 67-75; C: B. Smith 65-75. 15T PS Hop (Bill Mackay Trophy): G. Negus 44-45. 25T Skeet Hop: 1st R. Elliot, 2nd L. Cook. HG: A. Deacon.

NARRANDERA 19-6-88 — Cloudy to fine, cold. 5T DB, 5PR DR EO: S. Guest shot the only possible; G. Dennis, M. Kruger-Davis, C. Salafia shot 14-15. Narrandera Club Mixed Targets C'ship: OA & A: G. Dennis, A. Paonne; B: B. Charles, G. Veely; C: W. Coraci, M. Kruger-Davis. 20T Hop CD: 2 possibles: M. Kruger-Davis and C. Salafia; G. Ceely shot 19-20. HG: C. Salafia 66-70.

NEWCASTLE 7-6-88 — Fine. Deauville Doubles & D/Rise C'ships. 20T EO:

# NEW SOUTH WALES CLAY TARGET ASSOC.

in association with

## SYDNEY/MARCONI CLAY TARGET COMPLEX

presents

# 1988 STATE TRAP CARNIVAL

1st-2nd-3rd OCTOBER

## SATURDAY

30 TARGET STATE HANDICAP  
50 TARGET STATE DOUBLE BARREL  
C'SHIP  
A.G.M. AT THE CLUB HOUSE

## SUNDAY

50 TARGET STATE SINGLE BARREL C'SHIP  
50 TARGET STATE POINT SCORE C'SHIP

## MONDAY

OPEN — LADIES — JUNIOR STATE TEAMS  
75 TARGET STATE CHAMPION OF  
CHAMPIONS

President:  
Robby Smith  
(02) 528 3878

Secretary:  
Jenny Burt  
(067) 65 2520



# N.S.W. GUN CLUB

## 13TH ANNUAL CHARITY SHOOT

### PRELIMINARY NOTICE

to be held on

**SATURDAY & SUNDAY,  
OCTOBER 29 & 30, 1988**

Watch for more details in future issues of  
C.T.S.N.

*Location: 131 Booralie Road, Terrey Hills, N.S.W. 5km from Monavale Road. Phone: 450 1775*

President: John Philipson, phone (H)  
949 4846

Secretary: Geoff Harvey, phone (H)  
449 6068

Treasurer: John Richardson, phone (B/H)  
489 5906

# N.S.W. GUN CLUB

## AUGUST 1988 PROGRAM

**AUGUST 6**

- 1.00p.m.  
**EVENT 1** Nom. \$25.00 O/S \$5.00  
100 Targets Olympic Trap
- EVENT 2** Nom. \$3.00  
10 Targets D/B E/O
- EVENT 4** Nom. \$14.00 O/S \$3.00  
50 Targets D/B Sweepstake
- EVENT 4** Nom. \$9.00 O/S \$1.00  
25 Targets S/B Sweepstake

**AUGUST 13**

- 12.00 Noon  
**SIMULATED FIELD SHOOT**  
See details elsewhere in CTSN
- AUGUST 20**

- 1.00p.m.  
**EVENT 1** Nom. \$3.00  
10 Targets D/B E/O
- EVENT 2** Nom. \$14.00 O/S \$3.00  
50 Targets D/B Sweepstake
- EVENT 3** Nom. \$9.00 O/S \$1.00  
25 Targets S/B Sweepstake
- AUGUST 27**

- 10.00a.m.  
150 Targets **ECONOMICAL SKEET**
- EVENT 1** Nom. \$12.00  
50 Targets Graded Sweepstakes
- EVENT 2** Nom. \$12.00 O/S \$3.00  
50 Targets Championship  
Badges A.B.C.
- EVENT 3** Nom. \$12.00 O/S \$3.00  
50 Targets Handicap

*Location: 131 Booralie Road, Terrey Hills, N.S.W. 5kms from Monavale Road. Phone: 450 1775*

President: John Philipson, phone (H)  
949 4846

Secretary: Geoff Harvey, phone (H)  
449 6068

Treasurer: John Richardson, phone (B/H)  
489 5906

# HAWKESBURY GUN CLUB LTD.

## SOUTHERN ZONE NIGHT POINTSCORE C'SHIP

FRIDAY, AUGUST 26, 1988 —  
6.00pm

and remember

*Every Friday night — 6.30pm D.T.L.  
Every second Saturday — 12.30pm —  
100 Target Skeet  
Every fourth Saturday — 12.30pm —  
D.T.L.*

President: J. Allotta  
(02) 631 8919

Secretary: R. Hunt  
(02) 601 7594 BH

# COWRA GUN CLUB Inc.

## *Annual Gold Cup Shoot*

Saturday 3rd and Sunday 4th September,  
1988

Program to include:

Jackpot trophy (Len Bird Shield in conjunction)  
Lachlan Valley D/B Championship  
Central Zone D/B Cont. Championship  
Central Zone NIGHT Pointscore Championship with  
N.S.W. MIXED TARGETS Championship and  
COWRA GOLD CUP event to be held Sunday.  
*Refreshments — Tea — Lunch — Cartridges  
available on the grounds*

Further information contact:

President:  
Noel Dwight  
(063) 42 2019A.H.

Treasurer:  
Peter Mould  
(063) 45 5837

## PRELIMINARY NOTICE

# COBAR GUN CLUB'S

## ANNUAL GOLDEN CLAY COMPETITION

will be held on

**23rd, 24th & 25th  
September, 1988**

# HAY GUN CLUB

*Location: turn left over railway line then right at  
last gate into showgrounds.*

**SUNDAY 7th AUGUST — 12 NOON**

25 Target Winter D/B Championship Graded  
A.B.C.

25 Target S/B Championship Graded A.B.C.

20 Target Double Barrel Handicap C/D

10 Target Club Mug S/B Handicap

**HIGH GUN MEDALLION ON ALL SHOOTS —**

**LADIES HIGH GUN MEDALLION WHEN TWO  
OR MORE LADIES**

*Ladies & Juniors ½ Noms — Refreshments  
available at club — Practice available before  
shoots*

# SYDNEY MARCONI CLAY TARGET COMPLEX

GROUND LOCATION: HEATHCOTE ROAD,  
LUCAS HEIGHTS. 16km ON LEFT FROM  
LIVERPOOL BRIDGE



OLYMPIC TRAP &  
ISU SKEET  
ELIMINATIONS



NSW 1989 TRAINING SQUAD ROUND

**AUGUST 27 & 28, 1988**

9am START BOTH DAYS

**200 TARGETS OLYMPIC TRAP**  
Overall and 1st AA.A.B.C. Grades  
Nom. including O/S \$70.00

**200 TARGETS ISU SKEET**  
Overall and 1st AA.A.B.C. Grades  
Nom. including O/S \$70.00

**100 TARGETS EACH DAY**

**CONTACT:**

**Chairman:**  
**Leni Crema**  
**(02) 604 0125**

**ISU Rep:**  
**Graham Boyce**  
**(02) 726 8638**

# N.S.W. GUN CLUB

**100 TARGETS**

**SIMULATED  
FIELD SHOOT**

**AUGUST 13, 1988 —  
12 NOON START**

<b>EVENT 1</b>	<b>Nom. \$7.00</b>
25 TARGETS CASH DIVIDE	
<b>EVENT 2</b>	<b>Nom. \$20.00</b>
75 TARGETS TROPHY (ALL GRADES)	

**OPTIONAL SWEEPS \$3.00**  
**TOTAL NOMS AND SWEEPS \$30.00**

**Location: 131 Booralie Road, Terrey  
Hills, N.S.W. 5km from Monavale  
Road. Phone: 450 1775**

**President: John Philipson, phone (H)**  
949 4846  
**Secretary: Geoff Harvey, phone (H)**  
449 6068  
**Treasurer: John Richardson, phone (B/H)**  
489 5906

## Reminder Notice Brewarrina Gun Club

Two Day Continental Shoot  
17th & 18th September

Including State and Zone Championships  
Full program in the September Clay Target News

## CANBERRA INTERNATIONAL CLAY TARGET CLUB

CLUB LOCATION: NORTHERN END MAJURA ROAD  
EVENT 1 Sunday 28th August — 10am Start Nom. \$3.00

EVENT 2 5 Pairs Double Rise C/D Nom. \$14.00 O/S \$1.50  
25 Pairs Club Double Rise Championship. Graded AA.A.B.C.  
O/S 50c each 25, 50c O/A

EVENT 3 Inter-Club Competition 20 Target I.M.I. Trophy 18 metres Nom. \$7.00 O/S 50c  
O/S 50c O/A. Five shooters per club team

EVENT 4 20 Target Handicap 1st, 2nd, 3rd & F/M Nom. \$8.00 O/S 50c  
O/S 50c O/A

HIGH GUN SWEEP 50c  
TOTAL NOMS (incl. sweeps) \$35.00

High Gun & Inter High Gun Trophies  
President: Norm Simms Secretary: Allan Lucas  
(062) 58 2033 (062) 92 3805

## NARRANDERA CLAY TARGET CLUB

Sunday 21st August, 1988 10.30am

N.S.W. State D/Rise Championship  
O/A 1st & 2nd A.B.C.  
Riverina Zone D/Doubles Championship  
1st & 2nd

20 Target Handicap Trophy  
State Double Barrel Night Championship to commence at dark  
Meals available at the club

Secretary:  
L. Charles  
(069) 56 2154

President:  
A. Walker  
(069) 59 2687

## COROWA GUN CLUB

August 28 12.30pm Start

EVENT 1 — 5 Target Eyeopener  
EVENT 2 — 15 Target Double Barrel Handicap  
EVENT 3 — 20 Target Double Barrel Championship Graded, O/A  
Sash, 2 Ribbons and Trophies  
EVENT 4 — 15 Target Double Barrel Championship, Graded, O/A  
Sash, 2 Ribbons & Trophies  
Juniors & Ladies Half Noms — Ammo & Drinks available on  
grounds — New shooters welcome

Corowa Gun Club is situated 2km from Monument along Redlands  
Rd, take turn opposite Cemetery Corner. We are opposite the  
Indoor Cricket Centre.

Secretary:  
Rhonda Pearce (060) 33 2842 Joe Wilson PO Box 220, Corowa

President:  
Rhonda Pearce

1st C. Lindsay, J. Fryer 20-20, 2nd P. McDonald 19-20. 10PR DR C'ship: OA & A: T. Turner Jr 17-20; B: C. Lindsay, G. Marriott 16-20. 20PR DD C'ship: T. Turner & M. Margison 39-39. 10PR DR SS: T. Turner 17-20, C. Lindsay, G. Marriott, M. Sargison 16-20.

NEWCASTLE 21-5-88 — Overcast & windy. 10T DB EO: D. Norris, A. Green 10-10. 20T DB CD: R. Edwards, P. McDonald, M. Height, D. Norris, C. Diaz, G. Casey 19-20. 25T PS C'ship: OA: P. Pemberton 71-75; A: C. Diaz 69-75; B: A. Green 76-84; C: C. Ferguson 59-75. 25T Hop: 1st P. Pemberton 25-25, 2nd M. Height, 3rd C. Lindsay. Quail: P. Pemberton 12-15.

NEWCASTLE 28-6-88 — Heavy wind. 50T Skeet Bicentennial Hop: J. Pethybridge 58-62, R. Carr 57-62, L. Buxton 48-51. 50T Newcastle & District C'ship: A: S. Subonj 48-50; B: R. Carr 48-50; C: C. Lindsay 39-50.

NEWCASTLE 29-5-88 — Heavy wind. 50T Highfields Skeet C'ship: A: W. Clarke 47-50; B: H. Dare 48-50; C: C. Lindsay 45-50. 50T Nobby's Skeet Doubles: A: S. Subonj 44-50; B: J. Pethybridge 41-50; C: P. Pemberton 41-50. HG: J. Pethybridge 179-200.

NSW 4-6-88 — Overcast, cool (16). 100T Olympic Trap C'ship: OA: M. Diamond 93; A: R. Cangiano 88; B: C. Naudin 80; C: B. Alexander 80.

NSW 8-6-88 — Cold night (16). 10T SB 15m: Top Gun Award: C. Waterhouse, P. Armstrong 9-10. Members Trophy DB 5T 11m, 5T 14m, 5T 17m, 5T 20m: A: C. Waterhouse 18-20; B: F. Atarde 18-20; C: T. West 16-20. 10T Rabbit Run: C. Waterhouse 9-10, S. Metzler 9-10, J. Dunne, P. Payne 7-10. Special Encouragement Award: Betty McAllister. HG: C. Waterhouse 36-40.

NSW 11-6-88 — Fine (26). Simulated Field Shoot — 25T CD: C. Naudin 23, M. Agar 21, G. Smith 17. 75T Trophy: AA: C. Naudin 62; A: M. Agar 63; B: D. Schuster 44; C: I. Bruce 46.

PORT MACQUARIE 5-5-88 — Very wet, cloudy, dull, no wind (15). 10T DB EO 15m: 9 possibles: A. Colman, J. Mathiske, D. Harris, B. Crane, W. Neill, K. Neill, R. Pritchard, B. Edwards. 20T PS Trophy Graded 15m: A: W. Neill 58-60; B: B. Hooper 59-60; C: A. Colman 54-60; D: B. Hooper 55-60. 10T DB Hop. 5 possibles: A. Colman, J. Mathiske, C. McGlashan, B. Crane, A. McWhirter. 10T DB Cont Hop: 7 possibles: B. Hooper, A. Colman, J. Mathiske, B. Crane, A. McWhirter, K. Neill, R. Pritchard. 10T SB 15m Minis: B. Crane, A. McWhirter 9-10. HG: B. Crane.

SUNNY CORNER 12-6-88 — Fine, very cold (26). Fine, very cold (26). 25T A. Fratley Grade Cups: A: L. Arnold 79-79; B: R. Hibbert 24-25; C: R. Peters 25-25. 75T Mixed Blue Mountains Champion of Champions: OA: P. Hayman 122-125; AA: J. Curran 115-125, P. Lynch 109-125; A: P. Hayman 122-125, L. Arnold; B: F. Nicholson 117-125, A. Clarke 116-125; C: R. Peters 116-125, C. Fabri 96-125. 15T Hop: 2 possibles: P. Hayman, R. Hibbert. HG: P. Hayman 136-140.

SYDNEY 3-6-88 — Wild night (26). 20T EO: 2 possibles. 25T DB Hop: A & OA: A. Draper 25-25, C. Davenport 40-41; B: P. Ammoun 21-25, P. Failard 19-25; C: B. French 23-25, D. Salvaggio 22-25. 30T Trophy Event: A: G. Rootes 42-50, C. Davenport 38-50; B: W. Sully 42-50, D. Jones 39-50; C: J. Kim 41-50, H. Poullos 43-60. HG: G. Rootes 84-95.

SYDNEY 5-6-88 — Fine (36). 20T EO: 3 possibles. 50T DB C'ship: AA: J. Boulos 65-67, G. Rootes 64-67; A & OA: I. Petrina 60-60, L. Trew 59-80; B: P. Ammoun 48-50, D. Jenkins 47-50; C: M. Katalinic 47-50, A. Magri 45-54. 30T Trophy Event: AA: G. Rootes 49-50, B. Samuels 44-50; A: N. Burrows 48-50, R. Carr 45-50; B: D. Jones 45-60, P. Ammoun 44-60; C: A. Magri 39-50, D. Salvaggio 36-50. HG: G. Rootes 117-120.

SYDNEY 19-6-88 — Fine (55). 20T EO: 11 possibles. 25T Southern Zone M/T Hop: AA: G. Rootes 44-49, J. Boulos 39-49; A & OA: S. Toson 45-49, P. Abela 43-49; B: D. Jenkins 25-35, R. Abrahams 34-35; C: E. Osman 34-42, G.

Shroeder 33-42. 50T DB Trophy: AA: G. Rootes 49-50, V. Gatt 48-50; A: A. Draper 48-50, P. Rose 56-59; B: P. Ammoun 50-50, C. Biscossi 48-50; C: A. Magri 46-50, M. Schmitt 45-50. HG: G. Rootes 110-115.

TAMWORTH 22-5-88 — Cool & sunny (31). 25T CD: K. Warn, P. Nash, K. Richardson, L. Cameron, C. Birt. 75T Sporting Goods C'ship: OA: G. Lancaster 60-75; AA: J. Wilberforce 58-75; A: D. Jackes 58-75, D. Michie 57-75; B: V. Raszewski 52-75, B. Hodges 48-75; C: T. Wyatt 30-75, A. Whyte 28-75. Grade HGs: AA: J. Wilberforce 78-100; B: C. Burt 75-100; B: V. Raszewski 65-100; C: A. Whyte 33-100. Ladies HG: T. Wyatt 30-75.

TAMWORTH 5-6-88 — Wet (18). 6th Annual Ball Trap C'ship 100T: OA: C. Burt 122-131; AA: R. Vidal 121-131, D. Menck 91-100; A: M. Wade 91-100, C. Barton 90-100; B: G. Carlyon 87-100, G. Walters 83-100; C: T. Aceti 91-100, P. Nash 66-100.

TAMWORTH 19-6-88 — Overcast, cool (20). 25T CD Hop Skeet: S. Stanley, R. Prior, S. Nash, C. Barton, N. Hinds 25-25. 50T Family Hotel C'ship Skeet: OA: D. Michie 48-50; AA: C. Burt 47-50; A: C. Barton 43-50; B: R. Prior 45-50; C: R. Corney 43-50. 25T Doubles Skeet: R. Prior 22-25, C. Burt 21-25, D. Michie, M. Dengate, P. Nash, S. Nash 18-25.

TAREE-WINGHAM 11-6-88 — Fine, night shoot (7). 10T CD: S. Quartermain, R. Sky 10-10. 25T North Zone SB C'ship: D. Hineshelwood 24-25, S. Quartermain 22-25, R. Sky 20-25.

TAREE-WINGHAM 26-6-88 — Fine & sunny (15). 20T CD: B. Thurlow 20-20, S. Quartermain 19-20, P. Smith, D. Hineshelwood, P. Thompson, A. Colman, K. Beck. 25T DB Club C'ship: R. Marsden 31-32, B. Thurlow 30-32, D. Hineshelwood 27-29. HG: B. Thurlow 44-45.

THE FOREST 5-6-88 — Showery (22). 10T SB EO: J. Twarloh, G. Parris, K. Perkins, P. Pontello. 25T SB C'ship: AA: K. Perkins 30-31, P. McIntosh 29-31; B: T. Brand 21-25, G. Parris 25-30; C: J. Crompton 20-25, J. Twarloh 22-28. 25T DB CD: AA: P. Pontello 29-29, V. Elliott 35-36; B: T. Brand 31-31, G. Parris 30-31; C: G. Deaves 23-25, J. Crompton 25-29. 25T PS CD: AA: V. Elliott 75-75, P. Pontello 84-87; B: T. Brand 73-75, J. Ryan 71-75; C: J. Crompton 62-75, G. Deaves 65-71. HG: P. Pontello 153-157.

TOTTENHAM 29-5-88 — Fine (5). 20T Gordon Keen Hop: A. Brodin, April; A. Rice, May.

WAGGA 5-6-88 — Cold, wet, windy (10). 10T SB EO: No possibles. 25T SB W.G.C. C'ship: OA: E. Vincent 21-25; AA: B. Rooke 18-25; B: A. Devine 19-25; C: J. Considine 16-28. 25T Ball Trap CD: B. Rooke 19-25, W. Hulm 17-25, A. Devine 17-25. OA HG: A. Devine 44-50.

WAKEHURST 15-5-88 — Fine & sunny (41). 30T DB C'ship: OA: N. Loucas 30-30; A: P. Lahood 28-30; B: B. Crane 28-30; C: C. Abela 29-30.

WEST WYALONG 21-5-88 — Fine (18). 20T Hop Trophy: L. Redfern 25-25, T. Murray 24-25, C. Foster 19-20. 25T Blast District DB C'ship: OA & B: P. Barnes 26-26; A: G. Schneider 25-26; C: C. Foster 23-25. 10T CD 16m: A. Boyd, P. Barnes, N. Williamson, L. Redfern 10-10.

WEST WYALONG 29-5-88 — Cloudy & cool (10). 100T Trench C'ship: B & OA: T. Murray 90-100; A: V. Kalmis 85-100; C: G. Ceeley 80-100.

WEST WYALONG 19-6-88 — Overcast (27). 100T Grand Prix: 1st J. Rodgers 97-105, 2nd G. Fairman 96-105, 3rd B. Dent 90-100; 11-13m: R. Haynes 87-100; 15-17m: C. Foster 87-100; 18-21m: K. Maxwell 87-100; 22-25m: G. Schneider 79-100; Junior: P. Payten 85-100; Ladies: L. Blake 78-100; Veteran: N. Rodgers 86-100.

YAMBA 11-6-88 — Perfect (45). 20T DB SS: G. Harrison, B. Crane, G. Wilson, G. Baxter, J. Tainsh. 30T Big River DB C'ship: 1st AA & OA: J. Kent 37-37; A: P. Jensen 32-32; B: B. Crane 47-47; C: D. Fullwood 28-30; 2nd AA: G. Baxter 36-37; A: J. Tainsh 31-32; B: E. I. Burey 46-47; C: A. Coleman 28-33. 50T

Eastern States PS C'ship: OA: L. Buxton 147-150; 1st AA: D. Ellis 146-150; A: J. Tainsh 143-150; B: B. Crane 145-150; C: M. Ellis 131-150; 2nd AA: G. Wilson 141-150; A: P. Jensen 144-153; B: I. Burey 139-150; C: N. Van Dooren 129-150. President's Jackpot: B. Turner.

**YAMBA 12-6-88** — Perfect (52). 30T Big River PS C'ship: AA & OA: B. Walton 104-108; 1st A: K. Fuller 90-96; B: B. Crane 84-90; C: C. Stratton 78-90; 2nd AA: J. Kent 103-108; A: G. Bollen 87-96; B: M. Harrison 78-90; C: D. Fullwood 77-90. 50T Eastern States DB C'ship: OA: J. Kent 56-56; 1st AA: D. Ellis 82-83; A: G. Harrison 49-50; B: G. Lawrence 50-50; C: T. Ellis 47-50; 2nd AA: B. Walton 81-83; A: M. Wade 53-55; B: P. Hewitt 49-50; C: A. Coleman 53-60. 20T DB Cont SS: B. Finch, J. Whitters, B. Turner, P. Jensen, D. Ellis, N. Van Dooren, D. Chambers, P. Brown. Open HG: D. Ellis 345-360. Ladies HG: A. Harrison 241-320. Junior HG: T. Ellis 249-320. President's Jackpot: D. Ellis, B. Finch.



## VICTORIA

**BAIRNSDALE 4-6-88** — Fine (23). 10T EO Pts CD: P. Warren, L. Hine 29-30, D. Luelf, B. Webb 28-30. 20T Bairnsdale DB ("Something Fishy") C'ship: A & OA: S. Collins 42-43, L. Curtis 36-38; B: M. Huggins 41-43, B. Crane 38-40; C: J. Child 27-30, K. Newman 23-32. 20T Hcp: 1st B. Crane 20-20, 2nd P. Warren 19-20, 3rd A. Collins 19-21. 50T Quickshift Skeet C'ship: 1st G. Petruska 49-50, 2nd L. Beechey 48-50, 3rd W. Sangster 46-50. HG: P. Warren. Cake Shoot: A. Collins.

**BENDIGO 13-6-88** — Fine (80). 25T DB Cont: OA: R. Ross 36-36; A: T. Spence 35-36, T. Boucher 36-37; B: L. Roberts 27-28, L. Boucher 26-28; C: M. Scherger 25-26, S. Middlin 25-27. 25T PS: OA: S. Atkins 75-75; A: C. Dunn 74-75, R. Ross 73-75; B: L. Roberts 72-75, C. Tanner 72-78; C: M. Scherger 73-75, E. McRae 74-78. 50T DB: OA: J. Weightman 72-72; A: A. Kinnear 71-72, W. Calaby 80-81; B: J. Weightman 72-72, M. Polock 57-58; C: T. Phillips 47-51, S. Larcombe 46-51. HG: S. Atkins 148-150. Raffle: A. James.

**BENDIGO 19-6-88** — Fine (28). 50T Skeet: OA: M. Travern 47-50; A: G. Woodhatch 46-50; B: B. Billing 47-50; C: L. Roberts 46-50. 20T PS Tower CD: R. Ross 60-60, B. Billing, N. Frankling, G. Woodhatch 57-60.

**BOORT 5-6-88** — Rough, cold, rain, windy (24). 10T EO: C. Roberts, L. Roberts, L. Saunders, K. Burton, J. Dunstan. 20T SB C'ship: A: G. Broad 25-28, R. Rigney 15-20; B: C. Roberts 26-28, G. Tallis 18-21; C: P. Marsh 14-20, R. Whytcross 13-20. 20T SR C'ship DB: A: G. Broad 19-20; B: L. Baker 21-21; C: J. Absalom 18-20.

**CASTLEMAINE 11-6-88** — Poor (41). 5T EO: A. James, N. Frankling, B. Billings, W. Calaby, G. Woodhatch, J. Lendon, R. McClure, G. McClure, J. Garsed, J. Prime, L. Cook, N. Marinos. 20T DB C'ship: A: D.M. Iogeric 47-49, J. Garsed 46-49; B & OA: B. Billings 25-26, G. Bradley 24-26; C: W. Phillips 18-20, E. Goon 17-21. 10T DR C'ship: A: L. Cook 27-30, A. Jones 26-30; B: M. Pollock 22-30, J. Woodhatch 20-30; C: J. Prime 13-20, W. Phillips 16-30.

**CASTLEMAINE 28-6-88** — Cold (32). 20T DB: A: D. Loder 20-20, W. Calaby 19-20; B: B. Lendon 22-26, D. Marriott 21-26; C: D. Opperman 17-20, M. Dignan 15-20; Novice: 1st R. Leysham 17-20, 2nd B. McCoombe 15-20, 3rd R. Langridge 13-20. 20T PS: A: A. James 72-72, R. McClure 69-72; B: S. Middlin 56-60, J. Lendon 48-60; C: J. Billman 49-60, M. Dignan 57-72; Novice: 1st R. Langridge 46-60, 2nd S. Cracknell 39-60, 3rd R. Leysham 38-60. Shoot Mug: Mrs D. Langridge 7-80.

**CERBERUS 4-6-88** — Fine & mild (25). 60T Medley: A: N. Quick 57-60, W. Woodward 56-60; B: A. Wooley 56-60, S. Wright 52-60; C: B. Bennett 49-60, M. Roberts 48-60; OA: N. Quick; Junior: Scott Rose.

**ECHUCA 29-5-88** — Beautiful (54). 40T State PS DB: OA & A: 54-55; B: M. Cook 37-40; C: D. Healey 29-40. 25T DB C'ship: OA & A: J. Jolly 152-152; B: G. Henwood 24-25; C: D. Russell 22-25. 25T Ball Trap: OA & A: N. Berry 25-25; B: G. Henwood 24-25; C: D. Healey 22-25.

**ECHUCA 12-6-88** — Cloudy but dry (41). 25T DB C'ship: OA & A: N. Berry 36-37; B: B. Treloar 26-28; C: D. Russell 23-25. 25T Pts: OA & A: S. Atkins 73-75; B: R. Rees 73-78; C: C. Wellington 69-75. 40PR DR: OA & A: N. Berry 35-40; B: H. Nihill 37-50; C: A. Patten 28-40. 25T Skeet: OA & A: R. Rees 29-30; B: D. Russell 28-30; C: P. Dobson 26-29.

**EUROA 28-5-88** — Dull (24). 10PR DR CD: J. King 10-10, S. Atkins 9-10, S. James, G. McClure, N. Berry 8-10. 20PR DR C'ship: OA: S. Atkins 34-40; A: J. Decker 32-40; B: D. Jackell 31-40; C: C. Asquith 22-40. 20T DB C'ship: OA: G. McClure 28-28; A: S. Atkins 27-28; B: K. Robinson 24-25; C: C. Asquith 17-20. 20T PS C'ship: OA: G. McClure 75-75; A: S. Atkins 72-75; B: K. McKendrick 57-60; C: C. Asquith 53-63.

**EUROA 25-6-88** — Dull (19). 10T DB Cont CD: T. Nash, S. Threlfall, W. Calaby, T. Apps, N. Berry 10-10. 20T DB Cont C'ship: OA: T. Nash 20-20; A: N. Berry 19-20; B: S. Threlfall 19-20; C: C. Asquith 19-20. 20T SB C'ship: OA: R. Barnes 19-20; A: T. Apps 20-22; B: D. Collihole 17-20; C: M. Dignan 14-20. 20T DB C'ship: OA: W. Calaby 38-38; A: N. Berry 37-38; B: D. Collihole 37-38; C: C. Asquith 33-35.

**FOSTER 11-6-88** — Cold & wet (15). 10T PS CD: R. Jennings 30-30, D. Kent 29-30, I. Davidson 27-30. 20T Medley (10T DB, 10T SE): 1st I. Davidson 29-30, 2nd W. Perry 28-30, 3rd R. Jennings 26-28; sponsored by Cliff & Ian Prain. 10PR DR Club C'ship: OA: J. Palfry 17-20; A: J. Green 32-40; B: R. Barlow 22-30; C: L. Fincham 15-20. Daily HG: R. Jennings 44-50. 3-monthly HG: J. Green 123-150, donated by L. Fincham. Fish Shoot: D. Kent, N. Blunden, J. Palfry.

**FRANKSTON-AUSTRALIA 5-6-88** — Cold, windy (80). 10T Pts CD: 1st P. Regoni 30-30, 2nd S. Henwood 29-30, 3rd E. Reid 28-30. 30T Hcp: 1st P. Ryland 29-30, 2nd G. Henwood 51-53, 3rd E. Reid 50-53. 20T DB C'ship: A & OA: W. Woodward 27-27; B: J. Hollands 20-20; C: T. Knopp 18-20. 25T Ball Trap C'ship: A & OA: A. Collins 26-28; B: G.J. Magdziarz 23-25; C: J. Holland 20-25. 50T Skeet C'ship: A & OA: B. Bond 56-42; B: B. Old 44-50; C: G. Dennison 39-50. 25T Sporting Trophy: A: J. Raymond 22-25; B: J. Dutchman 20-25; C: B. Sandelson 19-25. 75T Trench C'ship: A: T. Rowe 65-75; B & OA: B. Eu 66-75; C: J. Holland 60-75.

**FRANKSTON-AUSTRALIA 12-6-88** — Fine (96). 10T Pts CD: B. Mark, M.

# RAAF POINT COOK GUN CLUB

## AUGUST 1988

**FRIDAY 5 7.00pm**

20 Target D/B C/D  
15 Target Pts C/D  
20 Target D/B Graded 1 & 2, A.B.C.

**FRIDAY 12 7.00pm**

20 Target D/B C/D  
15 Target Pts C/D  
20 Target D/B Graded 1 & 2, A.B.C.

**FRIDAY 19 7.00pm**

20 Target D/B C/D  
15 Target Pts C/D  
20 Target D/B Graded 1 & 2, A.B.C.

**SUNDAY 21 12 NOON**

**TRI-WEST REAL ESTATE CHAMPION OF CHAMPIONS DAY**

10 Target Pts C/D  
20 Target Points  
20 Target Single Barrel  
20 Target Double Barrel  
Champion of Champions over events 2,3,4  
O/A — Sash & Case of Shells  
1st each grade — Gold Medal & 200 Shells  
2nd each grade — Silver Medal & 100 Shells  
3rd each grade — Bronze Medal & 50 Shells  
Best Lady, Junior & Veteran on the day

**FRIDAY 26 7.00pm**

20 Target D/B C/D  
15 Target Pts C/D  
20 Target D/B Graded 1 & 2 A.B.C.

Location: RAAF Base, Point Cook, Point Cook Road, (off Melbourne to Geelong Freeway)  
Canteen facilities at all shoots

**President:**  
**Dave McLeod**  
(03) 368 1274(W)  
368 1481 (H)

**Secretary:**  
**Phil Pegg**  
(03) 368 1316 (W)  
369 6042 (H)

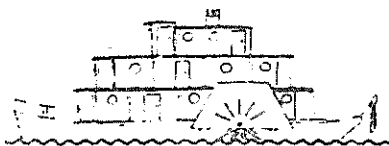

# ECHUCA GUN CLUB INC.

Sunday, August 14 — 12 Noon

- EVENT 1** Nom. \$15.00  
50 Target N.E. Zone Ball Trap Championship
- EVENT 2** Nom. \$7.00  
25 Target Double Barrel Championship
- EVENT 3** Nom. \$7.00  
25 Target Skeet Championship
- EVENT 4** Nom. \$5.00

— Time Permitting —  
15 Target Points Cash Divide  
*D.T.L. Practice available prior to shoot.*  
*Powered caravan and camping sites available at minimal cost.*

*Modern toilet block with hot shower.*

**President:** R.W. McKenzie (058) 52 1721  
**Secretary:** D.W. Penn (054) 82 3604

# EUROA CLAY TARGET CLUB INCORPORATED BICENTENNIAL BASH

Saturday 27th August — 1pm Start

- EVENT 1** Nom. \$3.50  
10 Target D/B Continental C/D
- EVENT 2** Nom. \$8.00  
25 Target AUSTRALIAN BICENTENNIAL D/B CONTINENTAL CHAMPIONSHIP  
1st O/A Sash and Trophy. 1st grades A.B.C. — Trophies
- EVENT 3** Nom. \$7.00  
25 Target TROPHY HANDICAP  
1st, 2nd, 3rd & B/Marker Trophies
- EVENT 4** Nom. \$7.50  
20 Target AUSTRALIAN BICENTENNIAL P/S CHAMPIONSHIP  
1st O/A — Sash & Trophy. 1st grades A.B.C. — Trophies

*Optional Sweepstakes & Jackpot*

Shooting ground is located 7km south of Euroa via Hume Highway then Halsall's Road. "You have to dodge through the Freeway construction". See Signs!

**President:** R. Barns (057) 95 2638  
**Secretary:** W. Borden (057) 95 2866

# FRANKSTON/ AUSTRALIAN GUN CLUB

## SUNDAY AUGUST 21

# OLYMPIC DAY

*All profits to go to Frankston Australian Members selected for the 1988 Olympic Games.*

- Event 1. 50t Double Barrel Championship** Noms. \$12.00  
Overall winner case of shells, grade winners ½ case.  
Sponsored by Winchester.
- Event 2. 50t American Skeet Championship** Noms. \$12.00  
Overall winner case of shells, grade winners ½ case.  
Sponsored by State Bank Brighton.  
High Gun Trophy over events 1 & 2 case of shells sponsored by Winchester.
- Event 3. 50t Ball Trap Championship** Noms. \$12.00  
Overall winner case of shells. Grade winners ½ case.
- Event 4. 50t Trench Championship** Noms. \$12.00  
Overall winner case of shells. Grade winners ½ case.  
High Gun Trophy over events 3 & 4 case of shells.

*All targets used on the day are donated by Olimpyc Targets.*

*Refreshments donated by Mordialloc Hotel.*

*The day will be followed by a social night at the clubrooms.*

*Crayfish raffle etc. . . . Canteen open until 8.00pm.*



# FRANKSTON-AUSTRALIAN CLAY TARGET CLUB INC.

CLUB ROOMS, ROSSITERS ROAD, CARRUM DOWNS, PHONE: 782 1626  
PRESIDENT: Mr Brian Bond, 798 1315

## AUGUST PROGRAM

**Port Phillip Field & Game Shoot**  
50 Target Simulated O/A AA.A.B.C. & Restricted  
**SUNDAY 7th AUGUST**

**EVENT 1** 30 Target S/B Championship **Nom. \$9.00**

**EVENT 2** 40 Target D/B Championship **Nom. \$11.00**

**EVENT 3** 25 Target Ball Trap Championship **Nom. \$8.00**

**EVENT 4** 50 Target Skeet Championship **Nom. \$12.00**

**EVENT 5** 25 Target State Bank D/B Tower Championship **Nom. \$8.00**  
AA.A.B.C. D.T.L. grades will apply to discretion of club handicapper. Excellent trophies, case of shells for anyone shooting 100 straight (divided if more than one)

**EVENT 6** 50 Target Trench Championship **Nom. \$13.00**  
**SUNDAY 13th AUGUST**

**EVENT 1** 20 Target Points Championship **Nom. \$7.00**

**EVENT 2** 20 Target S/B Championship **Nom. \$7.00**

**EVENT 3** 20 Target D/B Championship **Nom. \$7.00**  
High Gun over events 1.2.3

**EVENT 4** 25 Target Ball Trap Championship **Nom. \$8.00**

**EVENT 5** 75 Target Skeet Championship **Nom. \$18.00**

**EVENT 6** 50 Target Trench Championship **Nom. \$13.00**

**SUNDAY 21st AUGUST — OLYMPIC DAY**  
*All profits to go to Frankston/Australian members selected for 1988 Olympic Games.*

**EVENT 1** 50 Target D/B Championship. Overall winner case of shells. Grade winners 1/2 case. **Nom. \$12.00**  
*Sponsored by Winchester*

**EVENT 2** 50 Target American Skeet Championship. Overall winner case of shells. Grade winners 1/2 case. **Nom. \$12.00**

*Sponsored by State Bank, Brighton*  
High Gun trophy over events 1 & 2 case of shells  
*Sponsored by Winchester*

**EVENT 3** 50 Target Ball Trap Championship **Nom. \$12.00**  
Overall winner case of shells. Grade winners 1/2 case.

**EVENT 4** 50 Target Trench Championship **Nom. \$12.00**  
Overall winner case of shells. Grade winner 1/2 case.

High Gun trophy events 3 & 4 case of shells  
*All targets used on day donated by Olympic Targets. Refreshments donated by Mordialloc Hotel, followed by Social Night at Club Rooms. Crayfish raffle etc. Canteen open till 8pm.*

### SATURDAY 20th AUGUST

**EVENT 1** 100 Target I.S.U. Skeet **Nom. \$23.00**

**EVENT 2** 100 Target Trench **Nom. \$25.00**

*(Come and give the Olympic team some competition)*

### SATURDAY 27th AUGUST

**Port Phillip Field & Game Shoot 75 Target Medley**  
25 Target Sporting, 25 Target Skeet, 25 Target D/B. 1 gun, 1 set chokes, shot gun down. High Gun trophy each section plus O/A AA.A.B.C. & res. \$20.00

### SUNDAY 28th AUGUST

**EVENT 1** 50 Target D/B Championship **Nom. \$12.00**

**EVENT 2** 25 Target Handicap 1.2.3 & B/M **Nom. \$8.00**

**EVENT 3** 25 Target Ball Trap Championship **Nom. \$8.00**

**EVENT 4** 50 Target Skeet Championship **Nom. \$18.00**

**EVENT 5** 25 Target Sporting Championship **Nom. \$8.00**

**EVENT 6** 75 Target Trench Championship **Nom. \$20.00**

**PRACTICE EVERY WEDNESDAY 12 NOON**

# DENILQUIN GUN CLUB

RACECOURSE RESERVE

**Sunday, August 21st**

Practice 11.30am; Start 12.30pm

**EVENT 1** — 10 Target Handicap Eye Opener

**EVENT 2** — 20 Target Handicap  
1st, 2nd, 3rd, Backmarker 22-25

**EVENT 3** — 20 Target Pointscore  
Overall and 2 grades

**EVENT 4** — 25 Target Double Barrel  
Championship

Overall and 2 grades; 2nd in grade  
— **TIME PERMITTING** —

**EVENT 5** — 10 Target Club Mug. *Sponsored  
by REPCO.*

Noms (incl. sweeps) — \$37.00

Lucky draw for free Noms — \$1.00

High Gun on Events 1-4

President: Ron Cugley  
(058) 81 4139

Secretary: Glen Beer  
(058) 81 3792

*The committee reserves the right to alter the  
programme*

## VENETO SOCIAL CLUB SHOOTERS

As part of his visit to Australia for the Australian Bicentennial Celebrations, Prof. Carlo Bernini, President of the Veneto Region, will attend a gala night in his honour at the Veneto Social Club, Bulleen on Saturday, September 3, 1988.

The President, for the occasion, has kindly donated trophies which he will present to overall and grade winners of the following combined events which will be shot at the Veneto Abruzzo Shoot to be held at the Melbourne Gun Club on: Sunday August 21, 1988. **Events: 25 Target Single Barrel; 25 Target Double Barrel; 25 Target Points.**

*Although these events are open to all shooters, only financial members of the club will be eligible to win these bicentennial trophies.*

Sergio Zotti

# SOUTHERN PENINSULA GUIDE AUGUST

**Cerberus Gun Club**

**Saturday 6**

10 Pr D/R E/O  
SOUTH EAST ZONE DEAUVILLE DOUBLES  
50 Target Double Barrel  
Sec: C. Carrol (03) 789 7926

★ ★ ★

**Mornington Clay Target Club Inc.**

**Saturday 13**

10 Target D/B  
50 Target D/B Championship  
Sec: R. Standeven (03) 546 1489

★ ★ ★

**Nepean Clay Target Club Inc.**

50 Target Simulated  
Overall, AA.A.B.C. Ladies, Juniors, Veterans  
Sec: N. Quick (059) 85 3580

# WERRIBEE GUN CLUB INC.

**Cnr. Leakes & Derrimut Rds.**

*Sunday 14th August*

Commencing at 12.30pm

Eyeopener **Nom. \$4.50**  
10 Target Pointscore

**EVENT 1** **Nom. \$7.50**  
20 Target Pat Mark Points Graded Championship  
**EVENT 2** **Nom. \$7.50**

20 Target D/B (4 groups)  
Junior High Gun trophy if 3 or more juniors  
competing

President: Bill Abbott Secretary: Trevor Brown  
A.H. 749 2422



# AMPOL PETROL

**PROUD TO BE AUSTRALIAN**

## VENETO ABRUZZO GUN CLUBS

*To be held at Melbourne Gun Club — 21st August*

EVENT 1	10 Target Eye Opener	Nom. \$6.00
EVENT 2	25 Target Single Barrel 1.2 A.B.C.	Nom. \$9.00
EVENT 3	25 Target Double Barrel A.B.C.D.	Nom. \$9.00
EVENT 4	25 Target Points 1.2 A.B.C.	Nom. \$9.00
EVENT 5	50 Target Skeet 1st A.B.C.	Nom. \$15.00

*Events 2, 3, 4 Sponsored by  
Incani Import, Sydney Road, Coburg*

Veneto & Abruzzo Gun Club  
would like to thank  
V. & A. Costanzo  
for sponsoring our  
Annual Inter Club Shoot against  
Marconi Gun Club

*Coaching free by R. Henwood — Canteen open*

S. Zotti 480 3028

E. Montanaro 846 2970

## COLBINABBIN CLAY TARGET CLUB INC.

Sunday, August 28 — at 1.00pm

C.R.T. 75 Target Medley Championship — \$18.00  
Graded A.B.C. & Juniors  
1st & 2nd each grade  
Optional Sweeps

President:  
A.W. Johns  
(054) 32 9370

Secretary:  
R.R. West  
(054) 32 9284

Dunkley, A. Brown, G. Mueleman, F. Botica, G. Smith, G. Dennison, P. Johnston, all possibles. 50T DB C'ship: AA: A. Bradshaw 69-71; A & OA: R. Collins 71-72; B: B. Eu 71-74; C: P. Vella 49-54. 25T Ball Trap C'ship: AA & OA: D. Nielson 30-31; A: B. Godfrey 29-30; B: L. Chaplin 25-26; C: A. Heffner 22-27. 100T Skeet C'ship: OA: D. Cunningham 106-108; A: L. Beechey 105-108; B: W. Diston 93-100; C: B. Sanderson 92-100. Teams — DTL: Melb: Collins, Godfrey, Whitelaw, Briggs 194-200; Frankston: Cunningham, Botica, Mills, Dennison 193-200; Skeet: Melb: Whitelaw, Thompson, Johnson, Moody 385-400; Frankston: Ryland, Cunningham, Guy, Parker 374-400.

**FRANKSTON-AUSTRALIA 19-6-88** — Fine, but windy (87). 30T Pts C'ship: A & OA: C. Ennis 87-90; B: R. Rees 88-96; C: S. Perry 80-90. 50T DB C'ship: A & OA: W. Parks 36-36; B: G. Henwood 29-30; C: P. Ryland 29-30. 50T Ball Trap C'ship: A: A. Bradshaw 46-50; B & OA: A. Reed 47-50; C: R. Soraci 40-50. 50T Skeet C'ship: A & OA: B. Thomson 59-60; B: T. Mills 44-50; C: R. Adams 45-50. 50T Trench C'ship: A & OA: D. Nielson 49-56; B: J. Golopidies 68-75; C: G. Avison 45-50.

**GEELONG 21-6-88** — (36). 10T Pts EO CD: J. Pistone, A. Bradshaw, R. Coombes, all 30-30. 30T DB Graded C'ship: A & OA: S. Haberman 65-65; B: O. Hayek 55-56; C: T. Hill 28-30. 20T SB C'ship: 1st S. Haberman 28-28, 2nd G. Haberman 19-20; B: R. Pistone 30-40; C: R. Sadler 11-20.

**GEELONG 29-6-88** — (49). 10T Hop EO CD: O. Hayek, N. Wenning, P. Cleary, S. Middlin, R. Coombes, S. Zotti, A. Faranda all 10-10. 20T Grouped Hop: 11-15m: M. Costa 38-39, A. Faranda 37-39; 16-20m: G. Faranda 23-23, L. Calandro 22-23; 21-25m: W. Robertson 19-20, T. Zagore 19-21. 30T DB C'ship: A & OA: J. Pistone 59-59, S. Haberman 58-59; B: O. Hayek 30-31, C. Zagore 34-35; C: W. Leather 28-30, T. Hill 30-33; Ladies: C. Zagore 29-30; Junior: T. Faranda 29-30. 10T SB C'ship: OA: R. Viney 11-11; A: S. Haberman 10-11; B: T. Faranda 10-11; C: G. Thorpe 8-10; Ladies: C. Zagore 8-10; Juniors: T. Faranda 8-10. HG: Open: R. Viney 59-60; Ladies: C. Zagore 53-60; Juniors: T. Faranda 53-60.

**GEELONG 5-6-88** — (26). 15T Pts EO CD: R. Coombes 43-45, G. Thomson 42-45, J. Matthey 41-45, R. Schwarz 41-45. 25T DB Graded C'ship: A & OA: R. Coombes 30-30; A: I. Dickens 39-41; B: C. George 29-30; C: T. Hill 23-25. 25T Pts Graded C'ship: OA: G. Thomson 72-75; A: S. Haberman 71-75; B: G. Pritchard 68-75; C: T. Hill 61-75.

**GEELONG 18-6-88** — (38). 15T Pts EO CD: W. Calaby 45-45, G. Thomson 45-45, D. Nielsen 44-45, M. Wallace 44-45. 30T DB Graded C'ship: A & OA: A. Bradshaw 35-35; B: J. Cleary 28-30; C: M. Wallace 34-35. 10PR DR Graded C'ship: A & OA: A. Bradshaw 20-20; B: O. Hayek 14-20; C: M. Wallace 12-20.

**HOPETOUN 25-6-88** — Cool & sunny (11). 52 DB EO: N. Hinneberg, C. Dalton, D. Barber, D. Afford 5-5. 25T Hopetoun & District SB C'ship: OA & B: C. Dalton 25-25, D. Afford 26-29; C: T. Foulton 20-25, B. Wallace 18-25. 20T Cash DB Hop: 1st D. Barber 24-25, 2nd I. Wilson 23-25, 3rd D. Afford 16-20.

**HORSHAM 11-6-88** — Cool & fine (32). N. Stewart Memorial Hop: OA: C. Budde 32-33; 11-15m: E. Kimberley 31-33, A. Briggs 26-28; 16-20m: D. Kennedy 36-37, A. Case 35-37; 21-25m: S. Bethune 23-25, J. Hinneberg 24-29. R. Jorgenson Snr Memorial C'ship: A & OA: R. Denby 35-36, S. Bethune 28-29; B: N. Hinneberg 34-36, C. Hair 26-27; C: J. Coleman 24-25, D. Harris 22-25.

**JEPARIT 19-6-88** — Perfect (38). 25T DuPont DB C'ship: A & OA: R. Duthie 46-46, D. Flavel 33-34; B: D. Barber 45-46, N. Hinneberg 30-31; C: J. Ough 24-25, D. Harris 21-25; Ladies: June Gawith 22-25, Junior: T. Flavel 23-25; Veteran: C. Maybery 18-25. 40T Club Mixed Target C'ship: B & OA: N. Hinneberg 59-60, D. Barber 54-60; A: R. Duthie 56-60, R. Black 67-74; C: J. Coleman 46-60, D. Harris 65-88.

**KANIVA 26-6-88** — Fine & sunny (17). 80T DuPont Medley C'ship: OA & A: R. Denby 110-120, B. Growden 122-134; B: P. Merrett 117-134, K. Howe 116-134; C: J. Krause 98-120, C. Mayberry 86-120. 10T Hop: C. Mayberry, P. Crane, E. Hall, 10-10. 5PR DR: B. Growden 10-10, J. Colwill 9-10, K. Howe, R. Black, C. Mayberry, 8-10.

**KERANG 18-6-88** — Light rain (27). 20T DB C'ship: A & OA: J. Dunstan 31-32, B. Rigney 20-22; B: A. Schrimmer 30-32, L. Roberts 27-29; C: J. Absalom 17-20, R. Whytcross 16-20. 20T SB Cont C'ship: A: S. Kerr 17-20, B. Rigney 15-21; B & OA: L. Saunders 18-20, L. Baker 21-30; C: J. Absalom 17-20, P. Marsh 13-21; Junior: L. Roberts 10-20. 20T PS CD: T. Smith 59-60, G. Tallis 57-60, B. Risney 55-60.

**KORUMBURRA 28-6-88** — Overcast, occasional light shower (32). 10T Pts: M. Wangman 30, P. White, I. Davidson, D. Kendall, W. Perry, N. Bell 29. 10PR DR: J. Green 27-30, B. Harmer 34-40, W. Perry 33-40. 50T Ball Trap: A: B. Harmer 66-71, W. Parks 65-71; B: N. Rouse 48, I. Davidson 44; C: W. Perry 45, N. Bull 43. Cake shoot: B. Harmer, M. Wangman, A. Sydneham, eq. 1.

**KYNETON 12-6-88** — Fine & overcast (40). 10T DB Mini EO: A: N. Frankling, A. James, R. McClure 10-10; B: M. Spencer, L. Roberts, C. Roberts, G. Tinkler, D. Marent 8-10; C: D. Vits, C. Lanyon, K. O'Meara 9-10. 20T DB Mini C'ship: A & OA: R. McClurk 25-25, G. Grant 25-27; B: R. O'Meara 24-25, C. Roberts 18-20; C: K. O'Meara 20-23, J. Kruse 19-23. 20T Pts Tower C'ship:

## MELBOURNE GUN CLUB

★ ★ ★ ★ ★ ★ ★ ★ ★ ★ ★ ★ ★ ★ ★ ★

### PRE-OLYMPIC SHOOT

★ ★ ★ ★ ★ ★ ★ ★ ★ ★ ★ ★ ★ ★ ★ ★

Saturday September 3rd

Sunday September 4th

100 TARGETS PER DAY

10am START ON BOTH DAYS

(Noms close at the last squads' completion of the first round.)

200 TARGETS OLYMPIC TRAP

Plus 25 Target final (flash targets will be used in the final)

2 Layouts in operation

Overall winner sash and trophy

1st & 2nd in AA.A.B.C. Juniors

Excellent trophies

Nominations: Open \$55, Junior \$40

Optional Purse: \$5, Optional Sweeps: \$2 per 50 Targets



\$500 CASH BONUS

To any three man team who can defeat our Olympic team of Russell Mark, John Maxwell and Domingo Diaz over the 200 targets. Free Nomination.



Practice from 1-3pm on Friday  
September 2.

# MELBOURNE GUN CLUB

Victoria Road, Lilydale 3140. (P.O. Box 74) — (03) 739 1771

## AUGUST PROGRAM

**Saturday August 6 — Commencing 12 Noon**

**EVENT 1** Nom. \$22.00

75 Target Trench Graded Championship  
A.B.C.

**EVENT 2** Nom. \$16.00

50 Target D/B Graded Championship  
AA.A.B.C. Sash & Ribbons

**EVENT 3** Nom. \$9.00

25 Target S/B Graded Championship A.B.C.

**EVENT 4** Nom. \$9.00

25 Target Pts Graded Championship A.B.C.

**EVENT 5** Nom. \$21.00

75 Target Skeet Graded Championship  
AA.A.B.C. Sash and Ribbon

**EVENT 6** Nom. \$9.00

25 Target Skeet Doubles C/D

**Saturday August 13, Commencing 12 Noon**

**EVENT 1** Nom. \$17.00

50 Target Trench Trophy Event A.B.C.

**EVENT 2** Nom. \$9.00

25 Target S/B Graded Championship A.B.C.  
Ribbon & Trophy

**EVENT 3** Nom. \$9.00

25 Target D/B Graded Championship A.B.C.  
Sash O/A

**EVENT 4** Nom. \$9.00

25 Target D/B Trophy Event A.B.C.

**EVENT 5** Nom. \$21.00

75 Target Skeet Graded Championship A.B.C.  
Ribbon & Trophy

**Saturday August 20, Commencing 12 Noon**

**EVENT 1** Nom. \$16.00

50 Target D/B Graded Championship A.B.C.  
Sash O/A

**EVENT 2** Nom. \$9.00

25 Target Group Handicap 1st each group  
11-14, 15-17, 18-21, 22-25

**EVENT 3** Nom. \$26.00

100 Target Skeet Graded Championship  
AA.A.B.C. O/A Sash 3 grade ribbons

**Saturday August 27, Commencing 12 Noon**

**EVENT 1** Nom. \$26.00

100 Target Trench Graded Championship  
A.B.C.

**EVENT 2** Nom. \$9.00

25 Target S/B Graded Championship A.B.C.

**EVENT 3** Nom. \$16.00

50 Target D/B Graded Championship O/A  
A.B.C.

**EVENT 4** Nom. \$6.00

15 Target Handicap 1.2.3 21-25m

**EVENT 5** Nom. \$26.00

100 Target Skeet Graded Championship  
AA.A.B.C. O/A Sash & Ribbon 3 grades

*Reduced nominations for Ladies and Juniors*  
**PRACTICE AVAILABLE FROM 10.30am SATURDAYS**

**President: R. Buchan**  
(03) 739 1771

**Secretary: Mrs Jan Brunt**  
(03) 762 8448

A & OA: N. Paterson 78-78, G. Hall 77-78; B: C. Roberts 74-75, G. Tinkler 73-75; C: K. Brown 56-60, J. Kruse 55-56.

**MELBOURNE 14-5-88** — Fine (116). 25T Pts Grd C'ship: OA & A: A. Blease 74-75; B: B. Henwood 75-78; C: J. Santilli 66-75; Novice: F. Mancuso 60-75. 25T DB Grd C'ship: OA & A: T. Bradshaw 56-56; B: B. Old 52-53; C: J. Woods 28-29. 25T SB Grd C'ship: OA & A: A. Blease 25-25; B: S. Zotti 24-25; C: M. Wright 21-25. 100T Robert Old Skeet Grd C'ship: OA: B. Thomson 100-101; AA: I. Hale 100-102, B. Dudenas 99-101; A: P. Asher 97-100, M. Whitelaw 98-100; B: P. Giddings 96-100, R. Carr 95-100; C: M. Richmond 89-100, B. Moss 88-100; Lady: C. Ogden 89-100; Junior: T. Eu 73-100.

**MELBOURNE 28-5-88** — Cold & wet (60). 20T Pts Grd C'ship: OA & A: T. Spence 60-60; B: B. Pallant 59-60; C: M. Harwood 51-60; Novice: F. Mancuso 54-66. Club All Round Trap Grd C'ship: OA: P. Johnston 39-45; A: T. Spence 37-45; B: S. Zotti 38-45; C: M. Harwood 30-45. 50T Skeet Grd Trophy: OA & B: F. Thatcher 62-64; AA: G. Guy 46-50; A: N. Moore 48-50; C: G. Carroll 37-50; Lady: C. Ogden 44-50. 25T Skeet Grd Trophy: A: L. Mauger 25-25; B: G. Thomas 25-25; C: W. Heard 23-25. Skeet HG: G. Thomas 74-75.

**MELBOURNE 4-6-88** — Fine (66). 15T Hep: 1st D. Bienvenu 15-15, 2nd B. Perks 20-21, 3rd G. McClure 19-21; 19-21m: R. Godfrey 14-16; 22-25m: J. Mollica 11-15. 25T SB Grd C'ship: OA & A: P. Johnston 24-25; B: M. Costa 23-25; C: W. Rogason 19-25; Novice: D. Gowie 20-29. 25T DB Grd C'ship: OA & A: G. McClure 39-39; B: A. Baker 24-25; C: P. McRae 23-25. 25T Skeet Grd C'ship: OA & AA: P. Krumins 75-75; A: R. Moody 74-75; B: B. Old 70-75; C: S. Corlett 68-75.

**MELBOURNE 11-6-88** — Cold & showers (156). 25T City of Melbourne DB Grd C'ship: AA: A. Brown 92-93, B. Lobley 57-58; OA & A: R. Viney 93-93, G. Ash 75-76; B: G. Magdziarz 42-43, R. Blackwell 26-27; C: A. Heffner 38-37, W. Salomon 35-37; Lady: P. Wass 23-25; Junior: W. Salomon 24-25. 25T Hep: 1st A. Mules 28-28, 2nd D. Nielsen 30-32, 3rd M. Briggs 29-32; 18-20m: F. Botica 35-38; 21-23m: R. Godfrey 22-25; 24-25m: M. Green 17-25. 20T SB Grd C'ship: AA: T. Bradshaw 18-20; A: B. Hunter 19-21; B: S. Zotti 20-21; C: A. Tesoriero 19-20. HG: F. Botica 49-50. 100T President's Skeet: OA: P. Johnston 99-100; AA: D. Cunningham 106-108, G. Guy 105-108; A: G. Smith 102-104, B. Attwood 98-101; B: B. Clark 95-100, J. McGregor 94-100; Lady: C. Ogden 93-100; Junior: T. Eu 86-100; C: G. Dennison 90-100, W. Adams 88-100. Zone Team: Melbourne 224-250, A. Blease, T. Peters, R. Collins, R. Godfrey, F. Vella.

**MELBOURNE 13-6-88** — Cold, strong winds (130). 25T Queen's Birthday Pts Grd C'ship: AA: J. Mollica 72-75; OA & A: R. Viney 82-84; B: N. Marinas 73-75; C: M. Dunkley 71-75. 50T Queen's Birthday DB Grd C'ship: OA: F. Botica 64-64; AA: D. Neilsen 64-68, W. Vella 63-66; A: W. Parks 84-85, B. Clark 83-85; B: I. Frantantara 63-64, M. Huehn 60-61; C: M. Dunkley 48-50, J. Woods 48-52; Lady: W. Adams 41-50; Junior: T. Faranda 48-50. 100T Queen's Birthday Skeet Grd C'ship: OA: P. Johnston 99-100; AA: D. Cunningham 98-100, B. Buchan 97-100; A: R. Dodds 96-100, M. Whitelaw 93-100; B: G. Petruska 93-100, C. Bennett 90-100; C: J. Santilli 90-100, G. Avison 88-100; Junior: D. Di Petro 86-100; Lady: C. Ogden 87-100. DTL HG: W. Parks 217-225. Skeet HG: D. Cunningham 294-300.

**MELBOURNE 18-6-88** — Cold & wet (63). 50T Pts Grd C'ship: OA: M. Whitelaw 146-150; A: C. Ennis 143-150; B: R. Bromley 144-150; C: M. Dunkley 137-150; D: J. Vella 118-150. 15T Novelty: A: B. Clark 14-15; B: N. Moore 14-18; C: M. Harwood 8-17. 10PR DD: 1st C. Ennis & A. Baker 19-20, 2nd M. Harwood & W. Heard 19-22. 75T Skeet Grd C'ship: OA & A: P. Krumins 75-75; B: G. Smith 76-83; C: S. Corlett 67-75.

**MELBOURNE 25-6-88** — Fine, light breeze (68). 50T Medley Grd C'ship: OA: B. Clark 100-100; A: A. Blease 94-100; B: R. Bromley 109-118; C: R. Henwood 85-100. 25T SB Grd Trophy: A: P. Johnston 24-25; B: B. Henwood 25-25; C: M. Harwood 18-26; Novice: D. Street 17-25. 50T Trench Grd Trophy: A: T. Rowe 43-50; B: B. Perks 37-50; C: J. Boote 37-50. 5PR Novelty Grd Event: A: M. Mifsud 9-10; B: L. Dodds 7-10; C: R. Moody 11-20. 75T Skeet Grd Event: AA: P. Johnston 74-75; A: R. Dodds 74-75; B: M. Mifsud 66-75; C: C. Sanger 66-75.

**METROPOLITAN 29-5-88** — Cool, fine (41). 15T Pts EO: L. Connell, K. Wright 45-45, B. Clark 44-45. 20T DB: A: J. Simeoni 20-20, B. Clark 33-34; B: C. Smith 20-21, R. Bromley 19-21; C: N. Pengelly 19-20, T. Basso 24-29. 20T DB: A: M. Piccolo 20-20, K. Wright 44-45; B: M. Rocco 20-20, R. Dodds 26-27; C: N. Pengelly 19-21, T. Mileo 18-21. 20T Hep: 1st C. Smith 19-2, 2nd R. Dodds 22-24, 3rd B. Antonello 21-24. BM P. McVicar 16-20. 50T Skeet: A: A. Bega 49-50, R. Dodds 47-50; B: A. Lorenzi 46-50, N. Basile 41-50; C: M. Giapitzakis 48-54, B. Antonello 46-52.

**METROPOLITAN 5-6-88** — Wet, cold (47). 25T DB: A: T. Spence 28-29, K. Calder 27-29; B: L. Dodds 29-30, T. Sofra 28-30; C: J. Santilli 23-29, T. Basso 22-29. 20T Pts: A: K. Calder 57-60, J. Smith 58-60; B: L. Dodds 56-63, T. Sofra 53-63; C: A. Rado 50-60, T. Basso 54-69. 20T Tower Pts: 1st L. Connell 81-81, 2nd R. Burrill 78-81, 3rd B. Lobley 74-75. 20T Hep: 1st L. Connell 26-26, 2nd O. Hayek 25-26, 3rd N. Sepe 19-20. BM P. McVicar 18-20. 50T Skeet: A: P. Krumins 49-50, A. Blease 55-58; B: O. Hayek 52-54, A. Harvey 48-51; C: J. Santilli 43-50, T. Sofra 38-50.

**METROPOLITAN 12-6-88** — Fine, cold (36). 10T Uls EO: M. Piccolo, K. Calder 30-30. 20T SB: A: B. Lobley 19-23, E. Lobley 18-23; B: R. Piccolo 17-20, O. Hayek 18-20; C: A. Rado 19-20, K. Austen 15-20. 20T Cont: A: J. Pistone 20-20, T. Spence 22-23; B: M. Salvatore 19-22, N. Sepe 18-22; C: J. Neumann 19-20, G. Faranda 17-20. 20T DB: 1st J. Pistone 24-25, 2nd J. Neumann 24-28, 3rd P. Mifsud 23-26. 50T Skeet: A: A. Bega 45-50; C: B. Antonello 44-50.

**METROPOLITAN 19-6-88** — Cold, wet (42). 25T DB: A: M. Smith 41-41, T. Spence 40-41; B: L. Dodds 25-25, O. Hayek 22-25; C: J. Santilli 22-25, N. Pengelly 19-25. 20T Pts: A: L. Connell 68-69, T. Spence 67-69; B: J. Sesto 60-60, O. Hayek 56-60; C: J. Santilli 50-60, N. Pengelly 46-60. 20T Tower Pts: 1st T. Spence 59-60, 2nd B. Lobley 106-108; 3rd A. Blease 105-108. 20T Hep: 1st K. Calder 22-24, 2nd J. Santilli 21-24, 3rd P. Krumins 20-23, BM P. McVicar 17-20. 50T Skeet: A: R. Dodds 48-50, P. Krumins 47-50; B: O. Hayek 50-50, R. Burrill 47-50; C: J. Santilli 48-50, M. Giapitzakis 42-50.

**METROPOLITAN 26-6-88** — Cold, windy (52). 25T DB: A: B. Clarke 23-25, B. Lobley 44-47; B: G. Magdziarz Snr 25-25, S. Zotti 24-25; C: G. Faranda 23-25, S. Lacombe 20-25. 50T Ball Trap: A: G. Magdziarz Jnr 45-50, J. Pistone 44-50; B: H. Weitzel 38-50, G. Magdziarz Snr 37-50; C: S. Scalora 31-50, T. Basso 18-50. 20T DB: 1st H. Weitzel 25-25, 2nd G. Magdziarz Jnr

# GEELONG CLAY TARGET CLUB INC.

Affiliated A.C.T.A.

P.O. Box 857, Geelong, Vic. 3220

*SPECIAL FUNDRAISING SHOOT — Sunday 14th August, 1988. All proceeds to assist Russell Mark, Australian Olympic representative, Seoul '88.*

1pm START E.O. CLOSE 1.45pm

- |                                    |                     |
|------------------------------------|---------------------|
| <b>EVENT 1</b>                     | <b>Nom. \$4.50</b>  |
| 15 Target Continental E/O          |                     |
| <b>EVENT 2</b>                     | <b>Nom. \$12.00</b> |
| 30 Target Continental Championship |                     |
| 1st A.B.C. Badge O/A               |                     |
| <b>EVENT 3</b>                     | <b>Nom. \$12.00</b> |
| 30 Target D/B Championship         |                     |
| 1st A.B.C. Badge O/A               |                     |

*The Geelong Clay Target Club extends an invitation to all shooters to assist in this worthy cause*

**President:**  
Noel Wenning  
Ph: (052) 43 9309

**Secretary:**  
Jack Powe  
Ph: (052) 75 1555

# KERANG CLAY TARGET CLUB INC.

presents

## ROBY MANUEL MEMORIAL SHOOT

Saturday 13th August — Commencing at 11.30am

- |   |                     |
|---|---------------------|
| <b>EVENT 1</b>  | <b>Nom. \$10.00</b> |
| 25 Target Ibis Traps Double Barrel C'ship Graded AA.A.B.C. & 2nd each grade                 |                     |
| <b>EVENT 2</b>  | <b>Nom. \$10.00</b> |
| 20 Target Roby Manuel Memorial Double Barrel Championship Graded AA.A.B.C. & 2nd each grade |                     |
| <b>EVENT 3</b>  | <b>Nom. \$10.00</b> |
| 20 Target Double Barrel Continental C'ship Graded AA.A.B.C.                                 |                     |
| <b>BARBECUE TEA AVAILABLE</b>   |                     |
| <b>NIGHT — Commencing at dark</b>   |                     |
| <b>EVENT 4</b>  | <b>Nom. \$10.00</b> |
| 20 Pair Club Deauville Doubles off 20m 1st & 2nd  |                     |
| <b>EVENT 5</b>  | <b>Nom. \$10.00</b> |
| 25 Target Single Barrel Championship Graded AA.A.B.C.                                       |                     |
| <b>Total Noms: \$50.00</b>  |                     |

*Optional Sweeps \$1.00 each event — High Gun over events 1,2,3 & 5 — Value \$100*

*Ladies, Juniors & Veterans trophy events 1,2,3 & 5 if 3 or more compete.*

*Ladies, Juniors & Veterans ½ Noms*  
Enquiries: Ring Faye Burton (054) 54 7245

# GEELONG CLAY TARGET CLUB INC.

## AUGUST PROGRAM 1988

Sunday 7th August — 1pm Start — E/O  
closes 1.45pm

- EVENT 1** Nom. \$4.00  
10 Target Pts E/O C/D
- EVENT 2** Nom. \$8.00  
25 Target D/B Championship A.B.C. Badge  
O/A
- EVENT 3** Nom. \$8.00  
25 Target S/B Championship A.B.C. Badge  
O/A
- EVENT 4** Nom. \$7.00  
10 Pr Double Rise Championship 1st, 2nd, 3rd  
F/M Badge O/A

★ ★ ★

**SATURDAY 20th AUGUST** 1pm Start

- EVENT 1** Nom. \$8.00  
25 Target Skeet Championship A.B.C. Badge  
O/A
- EVENT 2** Nom. \$12.00  
30 Target D/B Championship A.B.C. Badge  
O/A
- EVENT 3** Nom. \$8.00  
20 Target D/B Mini Championship 1st, 2nd,  
3rd F/M Badge O/A

★ ★ ★

**SATURDAY 27th AUGUST** 1pm Start  
E/O Closes 1.45pm

- EVENT 1** Nom. \$4.00  
10 Target Pts E/O C/D
- EVENT 2** Nom. \$8.00  
20 Target D/B Championship A.B.C. Badge  
O/A
- EVENT 3** Nom. \$7.00  
10 Pr Double Rise Championship A.B.C.  
Badge O/A
- EVENT 4** Nom. \$8.00  
20 Pr Deauville Doubles Championship 1st,  
2nd Badge O/A

President: N. Wenning  
Ph: (052) 43 9309

Secretary: J. Powe  
P.O. Box 857,  
Geelong, 3220  
Ph: (052) 75 1555

# Metropolitan Clay Target Club Inc.

O'Herns Road, Epping

## August Program

- SUNDAY 7** NOON START  
EVENT 1 — 25 Target Ball Trap A.B.C.  
EVENT 2 — 25 Target D/B A.B.C.  
EVENT 3 — 25 Target Pts A.B.C.  
EVENT 4 — 20 Target Handicap 1.2.3 & B/M  
EVENT 5 — 25 Target Skeet A.B.C.

- SUNDAY 14** NOON START  
EVENT 1 — 15 Target Pts E/O  
EVENT 2 — 25 Target D/B 1.2.3.  
A-18m, B-16m, C-14m  
EVENT 3 — 20 Target Single Barrel  
EVENT 4 — 20 Target Pts Tower 1.2.3  
EVENT 5 — 50 Target Skeet A.B.C.

- SUNDAY 21** NOON START  
EVENT 1 — 50 Target D/B A.B.C.  
EVENT 2 — 50 Target Pts A.B.C.  
EVENT 3 — 50 Target Skeet A.B.C.

- SUNDAY 28** NOON START  
EVENT 1 — 10 Target Pts E/O  
EVENT 2 — 20 Target D/B A.B.C.  
EVENT 3 — 20 Target D/B 1.2.3.  
EVENT 4 — 20 Target Handicap 1.2.3 & B/M  
EVENT 5 — 50 Target Skeet A.B.C.

*Nominations for E/O and first event each day  
will close at 1.30pm Sharp  
Practice: Saturdays 12-5pm — D.T.L., Skeet,  
Tower  
Tuesdays 12-5pm — D.T.L., Skeet  
The Committee reserves the right to alter any  
program if deemed necessary*

24-25, 3rd K. Calder 23-24. 25T Skeet: A: H. Weitzel 24-25, A. Bega 23-25; B: J. Santilli 22-25, D. Macartney 20-25; C: S. Ivancio 21-25, G. Magdziarz Smr 18-25. 15T Mini Tower: 1st A. Blease 12-15, 2nd H. Weitzel 12-15, 3rd R. Ivancio 11-15.

**MT BOGONG 5-6-88** — Lousy (27). 5T DB EO CD: B. Garvey, R. Taylor, R. Ehlers, J. West, D. Jackel, R. Moore, B. Bourke, all 5-5. 15T DB C'ship: A: R. Ehlers 20-21; B: V. Tomasoni 15-15; C: P. Leahy 13-16; Jnr: M. Hughes 12-15. 15T Hep: 1st V. Tomasoni 15-15, 2nd M. Tomasoni 15-16, 3rd K. Robinson 14-16. 15T Mini DB C'ship: A & OA: T. Penney 25-27; B: D. Hunt 14-15; C: R. Duffy 12-15.

**MORWELL 18-6-88** — Fine, cool (37). 10T EO: D. Kendall, D. Twaddle 30-30, B. Whykes, G. McMillan, B. J. Stokes, B. Perry, P. Hance, M. Marshall, 29-30. 25T DB Winter C'ship: A: B. Webb 41-42, G. Petruska 31-32; B & OA: M. Mariani 50-50, J. Hollands 49-50; C: L. Azzopardi 26-28, R. Jackson 25-28. 25T S.E. Zone DB Cont: A: B. J. Stokes 24-25, B. Webb 36-38; B & OA: L. Johnson 25-25, M. Mariani 24-25; C: L. Fincham 24-25, P. Hance 25-28. HG: A: B. J. Stokes; B: M. Mariani; C: L. Fincham. Raffle: F. Firth. Cake Shoot: J. Attard.

**MYAMYM 13-6-88** — Extremely wet (26). 25T Queen's Birthday DB Grd C'ship: OA & A: P. Green 25-25, W. Wombwell 24-25; B: H. Vaughan 24-27, Gary Hayden 23-27; C: A. Morrison 23-25, Glen Hayden 23-26. 25T DB Trophy Event 15m: OA & A: W. Wombwell 36-37, L. Howlett 35-37; B: B. Malseed 24-25, L. Sims 25-28; C: R. Rundell 22-25, D. Beyer 22-26. 25T Dist DB Cont C'ship: OA & A: P. Green 27-28, J. Fartch 26-28; B: L. Sims 23-25, M. Greene 26-29; C: Glen Hayden 21-25, T. Pettitt 20-25. HG: A: P. Green; B: L. Sims; C: A. Morrison; Junior: Glen Hayden.

**NEPEAN 23-5-88** — Perfect (98). 50T: a & OA: M. Iguanti 39-50, B. Lobley 38-50, K. Rose 37-50; AA: P. White 38-50, C. Seide 37-50; B: G. Carr 37-50, N. Quick 36-50; C: V. Kilkenny 33-50, W. Scott 32-50, J. Stone 32-50; Juniors: D. Scott 34-50, R. Carroll 27-50; Veterans: S. Henwood, W. Mann; Lady: J. Ainger.

**NOORAT 28-5-88** — Lousy, cold & wet (45). 30T Vandermeer & Northeast Graded C'ship: OA: B. Malseed 31-31; A: T. Grummatt 33-34; B. Cockayne 32-34; B: J. Hoss 30-31, B. White 32-33; C: Glen Hayden 33-34, B. Fleming 32-34. 30T Cont DB F.T. & B. Crimmin Graded C'ship: OA: T. Grummatt 29-30; A: C. Corneby 26-30, P. Vaughan 27-30; B: S. Henderson 33-35, P. Bodey 32-35; C: Glen Hayden 33-37, B. Hogan 32-37. 20T Hep: 1st P. Bodey 20-20, 2nd T. Grummatt 20-21, 3rd B. Cockayne 19-21. HG: T. Grummatt 79-83.

**NUMURKAH 22-5-88** — Fine (38). 25T DB: A: R. Ehlers 26-27, S. Aitkins 34-36; B & OA: B. Hanson 27-27, A. Plum 24-25; C: T. Rosenow 21-25, P. Maher 23-28. 25T DB Cont: A & OA: W. Cakebread 25-25, A. Cole 24-25; B: W. Brayson 29-31, J. Smith 28-31; C: M. Monteleone 21-25, J. Knight 19-25. 25T PS: A & OA: G. Pinner 75-75, M. Leonard 74-75; B: S. Trelfall 73-75, W. Brayson 80-87; C: T. Rosenow 59-75, C. Wellington 52-75.

**RAAF POINT COOK 27-5-88** — Cold (Night) (39). 10T Pts CD: R. Viney 30-30, J. Pistone, K. Burton, F. Burton, R. Sorace, M. Rocco 29-30. 20T DB Grd: A: B. Mark 20-20, R. Viney 19-20; B: K. Burton 20-20, T. Faranda 22-24; C: A. Barnes 20-21, T. Moscatt 19-21. 20T DB: T. Faranda, R. Viney 20-20, M. Zamperoni, T. Moscatt, M. Howden 19-20.

**RAAF POINT COOK 3-6-88** — Cold (Night) (39). 10T Pts CD: S. Zotti, R. Ahmling 30-30, A. Faranda, R. Viney, G. Haines 29-30. 20T DB Grd: A: R. Viney 20-20, D. Nielsen 29-31; B: G. Vella 33-34, S. Ziegler 32-34; C: G. Faranda 20-20, M. Wallace 21-23. 20T DB: G. Faranda, R. Viney, A. Ahmling, G. Vella, S. Rendall all 20-20.

**RAAF POINT COOK 10-6-88** — Very cold (Night) (25). 10T Pts CD: M. Zamperoni, V. Flower 30-30, R. Viney, A. Kennedy 29-30. 20T DB Grd: A: R. Viney 20-20, J. Pistone 27-29; B: D. Frost 20-20, G. Vella 18-20; C: M. Wallace 18-20, C. Faranda 29-31. 20T DB: R. Viney, B. Patterson, A. Barnes all 19-20. 20T DB: D. McLeod 20-20, M. Wallace 18-20, M. Zamperoni, D. Frost, A. Barnes, P. Galea 17-20.

**SEBASTOPOL 19-6-88** — Fine (31). R.F. Scott & Co. Central Highlands Champion of Champions 100T Medley: OA: G. Scarce 133-140; AA: J. Jolly 132-140, R. Schwarz 124-140; A: W. Calaby 128-140, D. Milojevic 126-140; B: J. Weightman 125-140, D. Waring 124-140; C: M. Dignan 125-140, V. Barby 119-140. Sincere thanks to R.F. Scott & Co., Lydiard St, Ballarat.

**SHEPPARTON 5-6-88** — Showery & windy (39). 25T Grd DB C'ship: OA & A: S. Atkins 32-32, R. Fiastri 24-25; B: W. Humphrey 26-27, J. Reynolds 32-33; C: D. Healey 31-32, A. Tesoriero 23-28; D: B. Eagle 19-25. 25T Grd PS C'ship: OA & A: D. Kay 95-96, S. Atkins 93-96; B: K. Fisher 71-75, S. Zotti 70-75; C: D. Healey 67-75, R. Bowen 69-78. 10PR Grd DR C'ship: OA & B: D. Healey 13-20, D. Calandro 18-20; C: A. Tesoriero 13-20, A. Patten; A: S. Atkins 27-30, R. Fiastri 25-30. 20T PS Cash: A: S. Zanca 55-60; B: T. Thomas 59-60; C: A. Patten 36-60.

**ST ARNAUD 26-6-88** — Very cool (34). 10T Pts EO: D. Freeman and L. Cook the only possibles. 30T Mt Yawong Medley C'ship (10T DB, 10T Pts, 10T SB): OA & A: D. Freeman 50-50, G. Hall 59-60; B: C. Rogers 48-50, C. Roberts 47-50; C: P. Watson 49-50, L. Roberts 46-50. 25T Mt Yawong DB C'ship: OA & A: D. Freeman 50-50, G. Cassells 45-56; B: C. Roberts 25-26, C. Roberts 29-30; C: P. Watson 36-38, L. Roberts 35-38. Royal Hotel Off The Fence Round 6: P. Watson. Royal Hotel HG: D. Freeman 105-105.

**SWAN HILL 12-6-88** — Good (18). 10T DB SS: D. Wilson, A. Mills, C. Penno, T. Dunstan 10-10. 10T SB SS: D. Wilson, G. Nalder, C. Penno, S. Bates 9-10. 10T Hep SS: G. Nalder, A. Day, L. Swinnerton 10-10. 10T PS SS: D. Wilson, G. Nalder, A. Mills, J. Dunstan 30-30. 5PR DR SS: D. Wilson 9-10, C. Penno, L. Swinnerton, J. Dunstan 7-10.

**SWAN HILL 26-6-88** — Fine, cold, good (13). 10T DB SS: D. Wilson, G. Lerm 10-10, P. Hutchinson, C. Penno 9-10. Mixed Targets Winter C'ship: D. Wilson 29-35, A. Turner 27-35, T. Robinson 36-47 after shoot-off with P. Hutchinson. Winter DR C'ship 10PR Grd: B & OA: A. Mills 28-40; A: D. Wilson 27-40; C: G. Nalder 12-20.

**TATURA 19-6-88** — Cool (37). 20T DB C'ship: OA: S. Atkins 42-43; A: W. Eagle 39-40; B: D. Collihole 41-43; C: P. Maher 17-20. 20PR DD C'ship: 1st W. Honne, G. Hall 20-20, 2nd S. Atkins, A. Spence 25-26. 10PR DR C'ship: OA: R. Fiastri 19-20; A: N. Berry 18-20; B: G. Pegg 18-20; C: T. Healy 13-20. 15T Hep CD: Divided between six shooters.

**TOOLONDO 5-6-88** — Cold, wet and windy (15). 5PR Auto and Driven CD: E. Kimberley, R. McDonald, D. Harris, I. Taylor all shot 7-10. 10PR Club Auto &

## Wangaratta Clay Target Club Inc.

Saturday August 20 — DTL —  
1.00pm Start

- EVENT 1 10 Target Double Barrel Eyeopener **Nom. \$4.00**
- EVENT 2 20 Target Double Barrel C'ship **Nom. \$8.00 O/S \$1.00**  
Sponsored by W.C.T.C. Ladies Committee  
1st & 2nd A.B.C. & Best Junior
- EVENT 3 40 Target North Eastern Zone Mixed Targets C'ship **Nom. \$13.00 O/S \$1.00**  
1st & 2nd A.B.C. Full sash for grade winners
- EVENT 4 20 Target Handicap 1st, 2nd, 3rd & B/M Ladies, Juniors & Veterans 1/2 Noms events 2, 3 & 4 High Gun Trophy over program

★ ★ ★

Sunday August 21 — Skeet —  
12.00 Noon  
Junior DTL — 1.30pm

- EVENT 1 25 Target Skeet C'ship **Nom. \$9.00 O/S \$1.00**  
O/A & A.B.C.
- EVENT 2 25 Target Skeet C'ship **Nom. \$9.00 O/S \$1.00**  
O/A & A.B.C.
- EVENT 3 25 Target Skeet Handicap 1st, 2nd, 3rd **Nom. \$9.00 O/S \$1.00**
- President: **Tony Penney**  
Ph: A.H. (060) 24 4215
- Secretary: **Bev Penney**  
Ph: B.H. (060) 55 5452

## Tatura Clay Target Club Inc.

21st AUGUST Shoot Date  
12.30pm Start

- EVENT 1 **Nom. \$8.00**  
O/S \$1.00  
25Tgt Criterion Hotel D/Barrel Ch'ship  
O/A, A.B.C.
- EVENT 2 **Nom. \$7.50**  
O/S \$1.00  
20 Tgt Criterion Hotel Points Score Ch'ship  
O/A, A.B.C.
- EVENT 3 **Nom. \$7.00**  
O/S \$1.00  
20 Tgt Criterion Hotel Silent Rise Ch'ship  
O/A, A.B.C.
- EVENT 4 **Nom. \$5.00**  
15 Tgt Continental Cash Divide

All Championships sponsored by  
Criterion Hotel, Tatura  
Practice 11.30. Cartridges, Hot Food. Heated Clubhouse.

President:  
H. Hawking  
Rushworth  
(058) 56 1227

Secretary:  
A. Moles  
Tatura  
(058) 24 1538

# VICTORIAN GUN CLUB

**Wednesday August 31**

**STATE NIGHT STANDARD  
SINGLES TOWER GRADED**

Overall Trophy and Sash  
Graded winner Trophy and Ribbons  
Second Trophy

## NOTICE

# VICTORIAN GUN CLUB

Would like to thank the following sponsors for the donations to the Anti-Cancer Council shoot on June 29:

E. Reid, F. Vella, V. Mollica, V. Flower, R. Mark, A. Dinatale, J. Pistone, G. Magdziarz, G. Vella, G. Freeman, R. Sorace, M. Zamperoni, R. Ahmling, J. D'Sesto, T. Moscatt, B. Mark, J. Gilopiois, P. Molluso, L. Delre, N. Stockdale, M. Mollica, J.F. Gauci, J. Muscat, N. Quick, Winchester, Footscray Panels, Dunlop Tyres, Walpamur Paint, B. Clark.

Money raised for the shoot for the Anti-Cancer Council was \$1,300.00.

# VICTORIAN GUN CLUB AUGUST 1988

**WEDNESDAY 3 6.30pm**

**EVENT 1** 10 Target Pts C/D **Nom. \$6.00**  
**EVENT 2** 15 Target D/B C/D **Nom. \$7.00**  
**EVENT 3** 15 Target D/B 1.2.3. **Nom. \$7.00**

**SATURDAY 6 12 Noon**

**EVENT 1** 10 Target Pts C/D **Nom. \$6.00**  
**EVENT 2** 20 Target D/B 1.2.3. **Nom. \$8.00**  
**EVENT 3** 20 Target D/B Graded A.B.C. **Nom. \$8.00**

**WEDNESDAY 10 6.30pm**

**EVENT 1** 10 Target Pts C/D **Nom. \$6.00**  
**EVENT 2** 15 Target D/B Handicap 1.2.3. **Nom. \$7.00**  
**EVENT 3** 15 Target Pts Graded A.B.C. **Nom. \$7.00**

**WEDNESDAY 17 6.30pm**

**EVENT 1** 5 Pr D/R C/D **Nom. \$6.00**  
**EVENT 2** 10 Pr D/R 1.2.3. **Nom. \$8.00**  
**EVENT 3** 16 D/R D/D Select **Nom. \$10.00**

**WEDNESDAY 24 6.30pm**

**EVENT 1** 10 Target Points C/D **Nom. \$6.00**  
**EVENT 2** 15 Target Pts C/D **Nom. \$7.00**  
**EVENT 3** 15 Target D/B 1.2.3. **Nom. \$7.00**

**WEDNESDAY 31 6.30pm**

**EVENT 1** 10 Targets Pts C/D **Nom. \$6.00**  
**EVENT 2** 25 Target S/B Tower Graded A.B.C. **Nom. \$15.00**  
— Time Permitting —  
**EVENT 3**

Location: Cnr. Geelong & Little Boundary Roads,  
Brooklyn

Secretary:  
Mr J. Gauci  
5 Wyalong St, Albion, 3020

President:  
Mr D. Mark

Driven C'ship: OA & A: W. Heard 22-40, R. McDonald 9-20; B: R. Jorgensen 21-40, M. Kingwell 9-20; C: E. Kimberley 12-20, I. Taylor 10-20. 15T DB CD: R. Jorgensen 14-15, W. Heard 13-15, B. Fabsat 13-15. 10T SB CD: E. Kimberley, R. Jorgensen, B. Fabsat all shot 8-10 Novice: L. Heard. Junior: C. Jorgensen. HG: R. Jorgensen 35-45.

**TYRENDARRA 4-6-88** — Windy (25). 60T Club Medley C'ship: OA & A: T. Grummett 78-80, A. Kinnear 71-80, P. Vaughan 70-80; B: L. Sims 69-80, N. Manson 68-80, G. Ross 67-80; C: C. Smith 69-80, C. Crawford 61-80, P. Begelholo 59-80. 25M Miss Out: T. Grummett, L. Sims.

**VENETO/ABRUZZI 19-6-88** — Cold, light breeze (50). 10T EO Pts Graded CD: A: V. Dalsanto, J. Simeoni 30-30; B: D. Dipteto 30-30, M. Wright, R. Blackwell, M. Costa 29-30; C: E. Bertollo 29-30, A. Tesoriero 28-30; 25T SB Grd C'ship: A: K. Gray 30-34, J. Simeoni 29-34; B: M. Mazza 23-25, J. Svensson 22-25; C: P. Mifsud 22-25, D. Brook 20-25. 50T DB Grd C'ship: A: V. Dalsanto 51-52, K. Gray 50-52; B: M. Mazza 56-57, S. Zotti 55-57; C: P. Mifsud 47-50, J. Simeoni 45-50; D: J. Laria 40-50. 60T Skeet Grd C'ship: A: R. Buchan 47-50; B: M. Harwood 45-50; C: P. Grace 46-50.

**VICTORIAN 25-5-88** — Cold (76). 10T Pts CD: N. Stockdale, A. Dinatale, D. Milojevic, D. Nielson, I. Fratararo, J. Gilopidis, F. Vella, C. Cutajar, K. Dunn, R. Ahmeling, M. Kowden 30-30. 15T Pts CD: G.T. Magdziarz, A. Bradshaw 45-45, N. Stockdale, J. Pistone, D. Nielson 44-45. 15T DB: E. Reid 26-28, N. Marinos 25-26, G. Magdziarz 22-23.

**VICTORIAN 1-6-88** — Cold (74). 10T Pts CD: L. Ahmeling, C. Cutajar 30-30, G.J. Magdziarz, D. Mark, V. Flower, F. Vella, T. Moscat, G. Freeman 29-30. 15T DB CD: V. Mollica, G.J. Magdziarz, M. Zamperoni, E. Reid, A. Dinatale, R. Evans, M. Smith, R. Sorace, N. Hassan, V. Flower, F. Vella, T. Moscat, R. Viney. 15T DB Graded: A: G. Went 25-25, G.J. Magdziarz 24-25; B: G. Magdziarz 19-19, P.N. Pyland 17-18; C: S. Mirans 20-21, J. Tamburro 19-21.

**VICTORIAN 8-6-88** — Cold & wet (73). 10T Pts CD: M. Zamperoni, G. Mirams, R. Ahmeling, M. Smith 29-30. 15T DB: R. Sorace, L. Ahmeling, J. Platten, R. Ahmeling, V. Flower, S.D. Trembath 15-15. 20T DB: 1st S.D. Trembath 26-26, 2nd F. Vella 25-26, 3rd N. Stockdale 24-25, FM P. Galea 18-20.

**VICTORIAN 16-6-88** — Cold (88). 10T Pts CD: J. Gilopidis, A. Bradshaw 30-30, F. Vella, V. Flower, R. Ahmeling 29-30. 15T DB CD: C. Cutajar, A. Dinatale, L. Spiteri, R. Perry, R. Ahmeling, T. Moscat 15-15. 15T DB Graded: A: V. Flower 43-44, F. Vella 42-44; B: L. Spiteri 15-15, G. Magdziarz 17-18; C: P. Vella 15-15, J.F. Gauci 16-17.

**WANGARATTA 21-5-88** — Cloudy & fine (48). 6PR DD EO: Possibles: M. Harwood & W. Heard, R. Phefley & A. Penney, G. Reid & F. Dowling, J. West & B. North. 20FR DD C'ship (Sponsor Caltex Service Station): 1st R. Ehlers & G. Boyd 25-26, 2nd K. Robinson & D. Jackel 24-26. 20T Gordon Witham Memorial DB C'ship: OA & A: W. Heard 44-44, G. Reid 43-44; B: A. Plum 53-55, G. Putkunz 52-55; C: M. Harwood 24-25, J. West 26-29; Junior: P. Amery 18-20. 20T Hep: 1st P. Pettit 21-21, 2nd D. Jackel 20-21, 3rd E. Dowling 29-30, BM G. Boyd 19-23. HG: D. Jackel 40-40.

**WANGARATTA 29-5-88** — Cool & sunny (33). 25T Skeet C'ship: OA: W. Charlton 33-33; A: G. Farish 24-25; B: T. Hargreaves 32-33; C: J. Reynolds 23-25. 50T Skeet C'ship: A & OA: W. Charlton 53-54, T. Jones 47-50; B: D. Jackel 52-54, M. Seymour 48-50; C: D. Love 44-50, V. Tomasoni 50-58. Attwood-Law Cup: W. Charlton 74-75. Schoolboys 10T SB: Open: B. Holloway 8-10, C. Milthorpe 7-10; Novice: T. Pigram 8-10, C. Norton 5-10.

**WANGARATTA 13-6-88** — Cold & cloudy (89). 10T DB EO: C. Sessions, R. Ehlers, C. Ziegler, P. Pettit, G. Pinner, G. Boyd, R. Blake, G.J. Magdziarz, N. Berry, A. Penney, T. Hargreaves all shot possibles. 20T DB C'ship (Sponsor Winchester Australia): OA & A: R. Ehlers 30-30, G. Boyd 29-30; B: T. Plum 23-24, N. Hore 22-23; C: C. Milthorpe 21-22, S. Mooney 20-22; Junior: M. Tomasoni 17-20. 20T Hep: 1st O. Hayek 28-29, 2nd C. Milthorpe 27-29, 3rd R. Potts 26-27, BM B. Eagle 18-20. 20T PS C'ship (Sponsor Chas. French & Son): A & OA: N. Berry 60-60, R. Blake 59-60; B: G. Magdziarz 57-60, J. Kelly 59-63; C: M. White 63-60, R. Duffy 52-60. 20T Cont C'ship (Sponsor Willoughby's Gas, Gun & Disposal Centre): B & OA: O. Hayek 27-28, T. Thomas 21-23; A: R. Blake 26-28, T. Hargreaves 23-25; C: W. Holloway 18-21, J. Pearce 15-21. HG: N. Berry 133-142.

**WANGARATTA 19-6-88** — Sunny & cool (16). 25T Skeet Doubles C'ship: OA: D. Jackel 28-33; A: B. Gribbon 27-33; B: B. North 18-25; C: J. Reynolds 19-25. 50T Skeet C'ship: OA & A: A. Penney 47-50, T. Jones 52-58; B: D. Jackel 46-50, H. Memery 38-50; C: B. Boyd 44-50, J. Reynolds 41-50. 10T SB Schoolboys: Open: S. Warren 9-10, C. Sessions 6-10; Novice: K. Norton 8-10, R. Sammon 6-10.

**WARRACKNABEAL 29-5-88** — Fine (95). 10T DB EO: R. Jorgensen, J. Hinneberg, R. Papat, R. Black, D. Figuel, P. Schilling, L. Martin, C. Dunn, J. Clark. 25T Trophy Shoot: 1st C. Dunn 51-51, 2nd Jim Gawith 50-51, 3rd T. Flavel 29-30, FM M. Phelan 20-25. 25T DB C'ship: A & OA: C. Dunn 79-79, L. Martin 78-79; B: D. Kennedy 31-32, R. Jorgensen 30-32; C: I. Wilson 27-28, C. Flavel 23-25.

**WERIBEE 5-6-88** — Wet & windy (52). 15T PS EO: D. Waring 45-45, N. Stockdale 44-45, G. Faranda 43-45, J. Gilopidis 43-45. 20T Hep 6 groups: 11-13m: P. Galea 20-20; 14-15m: S. Mirams 20-20; 16-17m: N. Stockdale 22-23; 18-19m: L. Gauoi 24-25; 20-21m: J. Pistone 21-21; 22-25m: M. Zamperoni 14-20. 20T DB C'ship: A & OA: J. Gilopidis 34-34, R. Viney 31-32; B: D. Waring 33-34, J. Finch 26-27; C: M. Wallace 27-28, C. Trembath 26-28.

**WONTHAGGI 20-5-88** — Calm but cold (10). Medley Event 10T DB, 10T SB, 10T DB Pts, 10T DB Cont (40T): A: W. Parks 57-60; B: F. Foon 54-60; C: D. Egan 50-60. 10T CD Hep Pts: F. Foon 29-30. Cake Shoot: F. Foon.

**WONTHAGGI 4-6-88** — Beautiful one day, perfect the next (as always) (32). 10T Hep: C. Burdett 12m, D. Egan 13m, W. Perry 16m, I. Kent 18m, K. Gray 17m, L. Horrocks 16m, W. Parks 20m, all possibles, 10-10. 40T SB Club C'ship: A & OA: W. Parks 39-40, C. George 38-40; B: S. Ziegler 38-42, W. Perry 37-42; C: D. Egan 34-40, L. Horrocks 33-40. 30T (15 off 15m, 15 off Hep): 1st W. Parks 30-30, 2nd W. Perry 37-38, 3rd G. Kent 36-38. Cake Shoot: K. Gray.

**WONTHAGGI 17-6-88** — "Pea Soup Fog" but no rain or wind (56). 25T S.E. Zone C'ship: A & OA: W. Parks 28-28, N. Court 27-28; B: G. Milkins 24-25, G. Kent 30-32; C: R. Hunter 23-25, R. Burgess 22-25. 25T Pts S.E. Zone C'ship: A & OA: W. Parks 87-87, K. Gray 86-87; B: F. Foon 67-75, G. Milkins 65-75; C: R. Burdett 72-75, S. Rose 62-75.

# BENALLA GUN CLUB

**Saturday, August 13 —  
1pm Start**

**EVENT 1 — 10 Target P/S Eye Opener**

**EVENT 2 — 40 Target Ted Moore Memorial  
Mixed Championship A.B.C. 1st & 2nd**

**EVENT 3 — 25 Target Deluxe Coachlines  
Handicap. 1st, 2nd, 3rd & BM. Return travel  
for two people to Adelaide.**

**EVENT 4 — 15 Target Continental  
Championship A.B.C. 1st each grade**

Founded 1965.

## KORUMBURRA GUN CLUB

2 kilometres past the town  
on the South Gippsland-hwy.

**SATURDAY AUGUST 27 — NOON**

## 1988 BIRTHDAY BONANZA

\$1,000 in prizes

10 Target Silent Rise C/D

20 Target D/B A.B.C. 1 & 2

20 Target Continental D/B 1.2.3

20 Target Points D/B A.B.C. 1 & 2

*Sponsored by Neil & Leanne Bull*

*Complimentary Sausage Sizzle provided after  
shoot*

**President: K. Cross  
(056) 64 2222**

**Secretary: K. Brown  
(056) 57 4263**



**BANNOCKBURN  
INTERNATIONAL CLAY  
TARGET CLUB INC.**

**SATURDAY AUGUST 13 —  
1pm Start**

**EVENT 1 — 10 Target E/O Cash Divide**

**EVENT 2 — 30 Target D/B Sash and Cash  
A.B.C.**

**EVENT 3 — 20 Target Points D/B 1.2.3**

**EVENT 4 — 20 Target Tower Points 1.2.3**

**President:  
S. Arklay  
(052) 78 1764**

**Secretary:  
Eddy Lugg  
(052) 75 1186**

**SHEPPARTON CLAY  
TARGET CLUB**

**Sunday, August 7**

**EVENT 1** 25 Target D/B Championship  
Nom. \$8.00 O/A O/S \$1.00

Sash each grade plus 1st & 2nd each grade  
Sponsored by John Reynolds Horizontal Boring

**EVENT 2** 25 Target Graded Continental C'ship  
Nom. \$8.00 O/A O/S \$1.00

Sash each grade plus 1st & 2nd each grade  
Sponsored by John Reynolds Horizontal Boring

**EVENT 3** 25 Target Graded Pointscore C'ship  
Nom. \$8.00 O/A O/S \$1.00

Sash each grade plus 1st & 2nd each grade  
Sponsored by John Reynolds Horizontal Boring

**EVENT 4** — Time Permitting —  
Nom. \$6.00

20 Target P/S Cash 1st each grade

**Sunday, September 4**

**EVENT 1** 25 Target Graded Double Barrel C'ship  
Nom. \$8.00 O/A O/S \$1.00

Sponsored by Tirana Motor Inn, Shepparton  
Sash each grade plus 1st & 2nd trophies each grade

**EVENT 2** 15 Pr Graded Double Rise C'ship  
Nom. \$8.00 O/A O/S \$1.00

Sponsored by Tirana Motor Inn, Shepparton  
Sash plus 1st & 2nd prizes each grade

**EVENT 3** 20 Pr Deauville Doubles C'ship  
Nom. \$8.00 O/A O/S \$1.00

ZONE CHAMPIONSHIP  
Sash and Prize 1st pair, prize 2nd pair

**EVENT 4** — Time Permitting —  
Nom. \$6.00

20 Target Graded Cash Points Score  
Cash prize 1st each grade

President: Steve Threlfall  
Ph: (058) 21 3679

Secretary: Alan Sims  
Ph: (058) 21 2908

Postal address: P.O. Box 126, Shepparton, 3630

Location: River Rd, Kialla. Turn off G.V. Hwy 7km south of Shep.  
P.O. opp. Ampol Roadhouse. Club is 5km due east on right.

**NEPEAN CLAY TARGET  
CLUB INCORPORATED**

**SATURDAY AUGUST 20th**

20 Gauge Competition run in conjunction with our  
novelty simulated event

Overall: 1 case "Scorpio" 20 Gauge Shells

1st each Grade: (AA.A.B.C.L.J.V.) — 100 "Scorpio"  
Shells

2nd each Grade: If enough shooters

Contact: Norm Quick — (059) 85 4416, 85 3580  
A/H. P.O. Box 129, Rye.

Directions: Boneo Road, Cape Schanck. Melway  
Map 200 G.6.



**TASMANIA**

**BURNIE 4-6-88** — Fine & cold (21). 50T Skeet: A: K. Campbell 45-50; B: K. Walker 43-50; C: G. Burgess 44-50. 25T Club SB: A: R. Young 28-31; B: S. Swan 23-25; C: G. Ennis 20-25. 25T Club DB: A: R. Young 24-25; B: K. Walker 23-25; C: L. Scott 22-25. 20PR DD: 1st D. Aylett & K. Aylett 19-20, 2nd M. Elliott & K. Walker 24-26. The E.Z. Shield was competed for between Rosebery, Smithton and Burnie clubs. The winner of the shield was Burnie with a score of 105-125. The Burnie team members were R. Young, K. Walker, R. Dawkins, M. Elliott, G. Burgess.

**BURNIE 18-6-88** — Wet. 50T SB Club (night): A: K. Aylett 39-50; B: R. Ward 44-50; C: M. Forrest 30-50. 20PR DR: A: K. Aylett 25-40; B: K. Walker 25-40.

**CRESSY 5-6-88** — Wet (38). 20T PS SS: A: S. Yates 60-60, G. Blaskett 59-60, A. Kenny, T. Atkins 58-60; B: K. Schott 60-60, D. Aylett 57-60, G. Cashion 53-60; C: L. Axton 58-60, D. Jurgers 53-60, K. Underlin 52-60. 20T DB: A: S. Yates 40-40; B: A. Blaskett 20-20; C: C. Lockwood 26-30. 25T Hcp: 1st J. Bryan 36-36, 2nd G. Blaskett 35-36, 3rd S. Yates 25-28. Club Cont DB C'ship: AA: T. Singline 29-30; A: K. Campbell 28-30; B: J. Bryan 28-30; C: K. Underlin 23-30. 10T Novice: D. Moore 16-18.

**DEVONPORT 18-6-88** — Overcast. 25T Skeet: A: G. Blaskett 25-25; B: T. Atkins 20-25; C: A. Blaskett 23-25. 10T PS EO SS: S. Browning, J. Murphy 30-30, K. Aylett, C. Rockliff, S. Yates 29-30. Jack Cunningham Memorial C'ship 50T DB: OA & AA: G. Blaskett 59-60; A: T. Atkins 49-50; B: J. Bryan 50-54; C: T. Ward 49-50. Norco Batteries Consistency Cup for 1987-88 was won by J. Bryan.

**HOBART 29-5-88** — Fine & freezing (33). 10T DB PS SS: L. Gray 30-30, D. Taylor 30-30, S. Browning 30-30. 20T SB: A: G. Blaskett 19-20; B: R. White 22-24; C: B. Howell 17-20. 30T Club DB C'ship: A & OA: S. Browning 36-36; B: J. Bryan 30-30; C: J. Nielsen 29-30. 50T South Dist. Olympic Trap C'ship: A: S. Browning 45-50, G. Blaskett 38-50; B: D. Aylett 40-50, R. Canell 39-50; C: G. Norris 58-75, D. Robinson 55-75.

**HOBART 13-6-88** — Wet & cold (45). 25T Skeet Hcp: 1st S. Marshall 59-60, 2nd N. Webb 61-62, 3rd E. Symons 60-62. 25T Skeet Graded: A: J. Briggs 42-42; B: G. Gourlay 30-30; C: D. Johnson 23-25. 25T Skeet Graded: A: J. Briggs 25-25; B: G. Gourlay 30-30; C: G. Cleary 24-25. 25T Skeet Hcp: 1st A. Blaskett 50-50, 2nd N. Mayne 41-42, 3rd J. Briggs 40-41.

**SMITHTON 12-6-88** — Fine, mild (30). 10T DB PS EO SS: Eq. 1st C. Cairns, P. Bransden, L. Scott 29-30. — 25T DB Club C'ship: A: S. Yates 29-32; B & OA: R. Abblitt 30-32; C: T. Buckby 22-27. 25T DB Cont Club S'ship: A: S. Yates 24-25; B: H. Von Stieglitz 25-25; C: L. Scott 23-25. Junior Shoot 10T DB PS: 1st C. Cairns 26-33 off 17m, 2nd K. Martwick 23-33 off 12m. 15T SB Cont SS: 1st D. Aylett 12-15, 2nd S. Swan, L. Scott both 11-15.

# TASMANIAN CLAY TARGET ASSOCIATION

## AUGUST:

STATE CONTINENTAL DOUBLE BARREL — BURNIE GUN CLUB — 6th AUGUST  
 STATE NIGHT POINTS SCORE — TASMANIAN GUN CLUB — 13th AUGUST  
 STATE NIGHT DEAUVILLE DOUBLES — BURNIE GUN CLUB — 20th AUGUST  
 STATE NIGHT CONTINENTAL DOUBLE BARREL — HOBART GUN CLUB — 10th SEPTEMBER  
 STATE NIGHT SKEET — BURNIE GUN CLUB — 17th SEPTEMBER

### BURNIE GUN CLUB

AUGUST 6th DAY SHOOT 11.00am

EVENT 1 — 10 Target Continental E/O S/S  
 EVENT 2 — State Continental D/B Championship Graded A.B.C.  
 EVENT 3 — S/S Event if time permits

\* \* \*

AUGUST 20th NIGHT SHOOT 6.00pm

EVENT 1 — 10 Pair D/Rise Targets off 22 metres E/O S/S  
 EVENT 2 — State Night D/Doubles Championship  
 Trophies and Sashes to first pair; Trophies and Ribbons to second pair  
 EVENT 3 — 25 Target Club S/B Event. Trophies each grade

\* \* \*

### ROSEBERRY GUN CLUB

AUGUST 27th 12.00 Noon

EVENT 1 — 5 Target Double Rise sweepstakes  
 EVENT 2 — 20 pairs Western Districts Double Rise. Ribbon and Trophy A.B.C. Grade High Gun sash overall  
 EVENT 3 — 15 Pair Deauville Doubles. Trophy 1st & 2nd pair. drawn partners  
 EVENT 4 — Shooter's choice

\* \* \*

### SMITHTON GUN CLUB

SUNDAY AUGUST 14th 11.00am

EVENT 1 — 5 Prs D/Rise E/O S/S  
 EVENT 2 — 10 Prs D/Rise A.B.C.  
 EVENT 3 — Junior Shoot  
 EVENT 4 — 25 Target D/B A.B.C.  
 EVENT 5 — Time Permitting

\* \* \*

### CRESSY GUN CLUB

SUNDAY AUGUST 7th 10.00am

EVENT 1 10 Target Pointscore Sweepstake Nom. \$4.00  
 EVENT 2 20 Target Novice — Trophy 1st, 2nd, 3rd Nom. \$6.00  
 EVENT 3 25 Target Single Barrel Graded Sweep Nom. \$7.00  
 EVENT 4 50 Target Ladies Committee Championship — Double Barrel. Graded AA.A.B.C. Nom. \$15.00

### DEVONPORT CLAY TARGET CLUB

AUGUST 20th 10.30am

EVENT 1 25 Target Skeet Graded A.B.C. Nom. \$7.50

EVENT 2 20 Target Double Barrel. Graded A.B.C. (Gordan Girdlestone Cup) Nom. \$7.00

EVENT 3 Don Brett Memorial Championship 50 Targets (25 Double Barrel, 25 Single Barrel) Graded A.B.C.

Overall winner sash and grade winners ribbons plus trophy (Norco Batteries Cup Event)  
 Sec: M. Bryan (004) 24 2292

\* \* \*

### BOTHWELL GUN CLUB

SUNDAY AUGUST 7 10.30am

EVENT 1 20 Target Point Score Sweepstakes Nom. \$6.00

EVENT 2 25 Target Mixed Meterage: 5-11, 5-15, 5-18, 5-20, 5-25. Trophy 1st, 2nd, 3rd Nom. \$7.00

EVENT 3 20 Target Handicap Trophy 1st, 2nd, 3rd Nom. \$6.00

EVENT 4 10 Pair Deauville Doubles Sweepstakes Nom. \$5.00

\* \* \*

### HOBART GUN CLUB INC. PROPOSED SHOOT — AUGUST

SUNDAY 28th AUGUST 9.30am  
 NATIONAL MUTUAL SPONSORED SHOOT

EVENT 1 20 Target NATIONAL MUTUAL DOUBLE BARREL CHAMPIONSHIP Graded A.B.C.D., Overall sash, Grade ribbons Nom. \$7.00

EVENT 2 20 Target NATIONAL MUTUAL DOUBLE BARREL HANDICAP 1st Overall — Trophy value \$100 and sash; 2nd Overall — Trophy value \$50 and ribbon; 3rd Overall — Trophy value \$25 and ribbon. Front Marker (11-14m) — Trophy value \$15 and ribbon. Commencing 1.30pm Nom. \$10.00

EVENT 3 50 Target RAY SMITH SPONSORED A.C.T.A. SKEET, Graded A.B.C. & Novice Trophy Nom. \$15.00

# Every Day Someone Wins with Beretta 682. Why Not Join Them!

## TRAP SKEET & SPORTING MODELS

Born from Beretta's dedication to sporting achievement, this new breed of competition gun features many mechanical and functional innovations - providing dedicated shooters with what could be described as the world's most advanced production over and under shotgun.

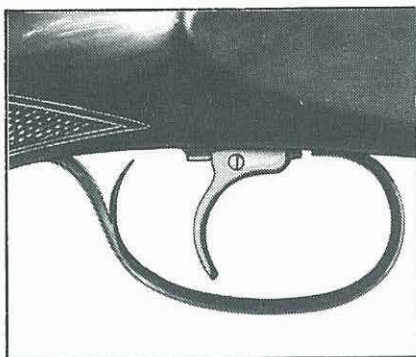

3 Position adjustable trigger allows 8mm of variation with ultra-fast lock times giving you that split second advantage when it counts.

can inexpensively maintain new gun fit forever, unlike other over and under shotguns which require expensive gunsmith attention should they wear loose following the rigors of extensive competition. In all they add up to a gun that's made to last in heavy competition.

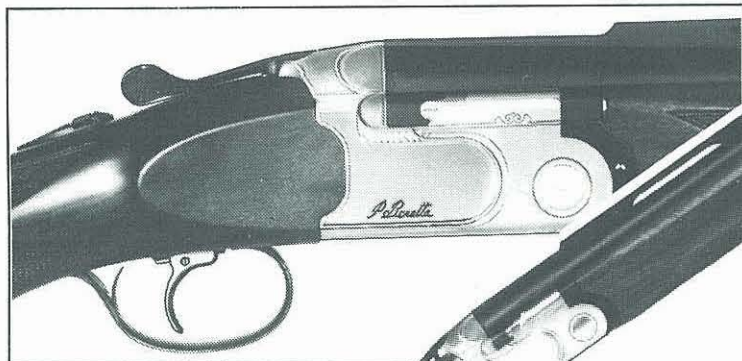

The low profile receiver with elegant engraving highlights the stylish easy to change barrel shoulders.

Features such as adjustable trigger giving you the length you need regardless of shooting attire. Medium high ventilated top rib with greatly improved sighting plane and full length ventilated side ribs for better cooling during extended competition. Matte finished Teflon 'Brunitor' coated barrels gives exceptional resistance to weather and abrasion, while the internal hard chrome lined bore provides the ultimate corrosion resistance. Yet another exclusive Beretta feature is the user replaceable barrel shoulders and hinge pins. Only Beretta 682 owners

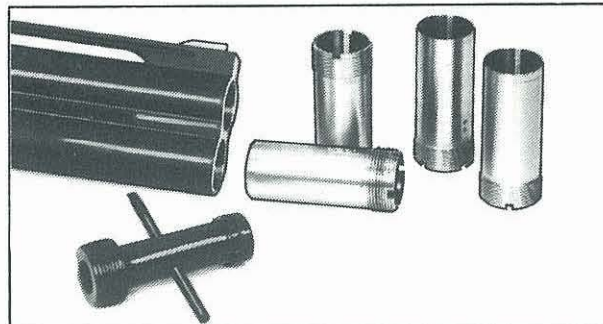

New flush mounting choke system that does not alter line of barrels. 4 chokes imp. cyl., mod., imp. mod., — and full. Key/thread cleaner come with guns featuring the mobilchoke system.

To complete the story the new \*682's come with Beretta's internal flush mounting mobilchoke system giving you infinite variations to suit both your style and type of shooting, in all a great case for Beretta.

And speaking of cases, the new 682's come in what can only be described as the greatest step forward in gun case design for over 20 years.

### BERETTA 682 SERIES

- 682 Trap: 75cm Barrels. Fixed choke I.M./F.
- \* 682 X Trap: 75cm Barrels. Fixed or Mobilchokes.
- 682 Skeet 71 cm Barrels.
- \* 682 sporting 71 cm Barrels Mobilchokes.
- \* 682 Lightweight Sporting Deluxe 71 cm Barrels Mobilchokes.



# Beretta

dal 1680

Italian designed slim line high fashion deluxe gun luggage, with moulded inserts for maximum protection. Features rebated carry handle, quality combination lock and provision for choke tubes and other accessories.

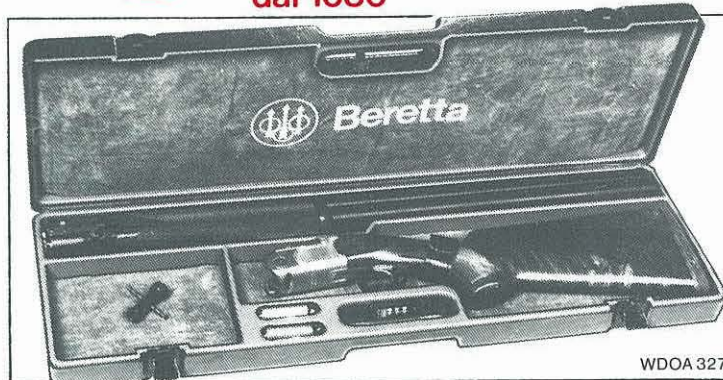

WDOA 327

Beretta  
Competition Guns gained  
Olympic Medal success at:



Melbourne 1956, Rome 1960, Munich 1972,  
Montreal 1976, Moscow 1980 and Los Angeles 1984.

# EXCELLENCE.

When you're looking for ammunition that's above and beyond all others look towards Winchester Superexcellence.

Australian ammunition that is scientifically designed and manufactured to the most rigid and exacting specifications. Every component gives you an edge, and that's what makes Winchester Superexcellence.

One piece compression formed plastic case with all brass base cup -

for superior strength and reloadability. Non-corrosive primer

- for quicker, sure ignition in all climatic conditions.

Olin Ball Powder® - clean progressive burning for

consistent power. Winchester Wads - for

superior gas sealing and improved

patterns. Winchester Shot - polished

alloy hardened for truer flight

and uniform patterns.

In a word

Superexcellence.

